

# Notes on Exodus

2024 Edition  
Dr. Thomas L. Constable

## Introduction

### TITLE

The Hebrew title of this book (*we'elleh shemot*) originated from the ancient practice of naming a Bible book after its first word or words. "Now these are the names of" is a translation of the first two Hebrew words.<sup>1</sup>

"The Hebrew title of the Book of Exodus, therefore, was to remind us that Exodus is the sequel to Genesis and that one of its purposes is to continue the history of God's people as well as elaborate further on the great themes so nobly introduced in Genesis."<sup>2</sup>

Exodus cannot stand alone, in the sense that the book would not make as much sense without Genesis. The very first word of the book, translated "now," is a Hebrew conjunction that means "and." Other Old Testament books that begin with this conjunction are: Joshua, Judges, Ruth, 1 and 2 Samuel, 1 and 2 Kings, 2 Chronicles, Ezra, Nehemiah, and Esther.

The English title "Exodus" is a transliteration of the Greek word *exodus*, from the Septuagint translation, meaning "exit," "way out," or "departure." The Septuagint translators gave the book this title because of the major event in it, namely, the Israelites' departure from Egypt.

"The exodus is the most significant historical and theological event of the Old Testament ..."<sup>3</sup>

---

<sup>1</sup>Quotations from the English Bible in these notes are taken from *The New American Standard Bible*, 2020 edition, unless otherwise indicated.

<sup>2</sup>Ronald Youngblood, *Exodus*, pp. 9-10.

<sup>3</sup>Eugene H. Merrill, *Kingdom of Priests*, p. 57.

## DATE AND WRITER

Moses, who lived from about 1525 to 1405 B.C., wrote Exodus (17:14; 24:4; 34:4, 27-29). He could have written it, under the inspiration of the Holy Spirit, any time after the events recorded (after about 1444 B.C.). He may have written it during the year the Israelites camped at the base of Mt. Sinai. He might have done so during the 38-year period of wandering in the wilderness, following the Israelites' failure to enter the land from Kadesh Barnea (cf. Num. 13-14; ca. 1443-1405 B.C.). On the other hand, he may have written it on the plains of Moab, just before his death (cf. 16:35). We cannot pin down the date of writing definitely.

These dates tie in with the date of the Exodus of the Israelites from Egypt, which will be discussed in my exposition of chapter 12.<sup>1</sup>

The founding president of Brandeis University, Abram Sachar, wrote the following about Moses, which articulates the skepticism of many scholars today:

"Yet of his life, of his very existence, we have no conclusive proof. Not a contemporaneous document, not a stele, not a shred of evidence, has been found to authenticate his historicity. Perhaps some day his existence, too, will be scientifically demonstrated, as Hammurabi's was, when, in 1902, the tablets of his laws were discovered."<sup>2</sup>

"It was the fad in the twentieth century to deny the historical reality of the man Moses."<sup>3</sup>

---

<sup>1</sup>See also Tremper Longman III and Raymond B. Dillard, *An Introduction to the Old Testament*, pp. 65-69; John D. Hannah, "Exodus," in *The Bible Knowledge Commentary: Old Testament*, pp. 104-5. On the Mosaic authorship of Exodus, see my note on the writer of Genesis and the sources referred to there, in my notes on Genesis. Kenneth Kitchen, "The Old Testament in its Context: 2 From Egypt to the Jordan," *Theological Students' Fellowship Bulletin* (1971):4-8, also has helpful background information on the Mosaic authorship of Exodus, Leviticus, Numbers, and Deuteronomy, as does Gleason L. Archer, "Old Testament History and Recent Archaeology from Moses to David," *Bibliotheca Sacra* 127:506 (April-June 1970):99-106.

<sup>2</sup>Abram Sachar, *A History of the Jews*, p. 16.

<sup>3</sup>Walter C. Kaiser Jr., "Exodus," in *Genesis-Leviticus*, vol. 1 of *The Expositor's Bible Commentary*, revised ed., p. 336. He proceeded to give evidence for Moses' existence.

"... most critics accept his [Moses'] historical existence, as a member of the Levi-Simon-Judah tribes, and, while discounting the subsequent idealization of his character and career, place him among the great religious leaders of all time."<sup>1</sup>

### SCOPE

Exodus embraces about 431 years of history: from the arrival of Jacob and his family in Egypt (ca. 1876 B.C.) to the erection of the tabernacle in the wilderness of Sinai (ca. 1445 B.C.). However, 1:1-7 is a review of Jacob's family. If we eliminate this section, the narrative resumes the story of the Israelites where Genesis ends, after the death of Joseph. About 364 years elapsed between the death of Joseph and the building of the tabernacle. The bulk of the book (chs. 3—40) deals with only two of those years, the year before and the year after the Exodus from Egypt. The Exodus event is clearly the focus of this book.

The Israelites lived in Egypt 430 years (12:40). Genesis 15:13 has the rounded number "400 years" as the total time of Israel's oppression in Egypt.<sup>2</sup> It may be helpful to remember that about 400 years elapsed between the end of Malachi and the beginning of Matthew, and that about 400 years elapsed between the end of Genesis and the beginning of Exodus.

### PURPOSE

"The purpose of the Book of Exodus is to celebrate God's gracious deliverance of His chosen people Israel from Egyptian slavery to the freedom of covenant relationship and fellowship with Him."<sup>3</sup>

---

<sup>1</sup>Sachar, p. 20.

<sup>2</sup>See the "Chronology Chart for Exodus" in John Davis, *Moses and the Gods of Egypt*, p. 14.

<sup>3</sup>Eugene H. Merrill, in *The Old Testament Explorer*, p. 41.

## GENRE

Like Genesis, Exodus contains a mixture of literary genres, including narrative, poetry, legal, and cultic.<sup>1</sup> As a whole, however, it seems best to classify the whole book as theological instructional history.<sup>2</sup>

## IMPORTANCE

"No other biblical book surfaces elsewhere in the OT as frequently as the Book of Exodus does; in the NT only the Books of Psalms and Isaiah are cited more, and that for the fairly obvious reasons of liturgy and messianism."<sup>3</sup>

"The deliverance of Israel out of Egypt by Yahweh in the Old Testament is parallel in importance to the resurrection of Christ in the New Testament. The historicity of these events is a critical foundation for a proper understanding of the rest of the Bible."<sup>4</sup>

## OUTLINE

- I. The liberation of Israel 1:1—15:21
  - A. God's preparation of Israel and Moses chs. 1—4
    1. The growth of Jacob's family 1:1-7
    2. The Israelites' bondage in Egypt 1:8-22
    3. Moses' birth and education 2:1-10
    4. Moses' flight from Egypt to Midian 2:11-15
    5. Moses' life in Midian 2:16-25
    6. Moses' call 3:1—4:18
    7. Moses' return to Egypt 4:19-31

---

<sup>1</sup>Herbert M. Wolf, *An Introduction to the Old Testament Pentateuch*, p. 127.

<sup>2</sup>Longman and Dillard, p. 72

<sup>3</sup>John I. Durham, *Exodus*, p. xxiii.

<sup>4</sup>J. Daniel Hays, "An Evangelical Approach to Old Testament Narrative Criticism," *Bibliotheca Sacra* 166:661 (January-March 2009):13.

- B. God's demonstrations of His sovereignty chs. 5—11
    - 1. Pharaoh's response to Moses and Aaron's initial request 5:1— 6:1
    - 2. Moses and Aaron's equipment as God's messengers 6:2—7:7
    - 3. The attestation of Moses and Aaron's divine mission 7:8-13
    - 4. The first three plagues 7:14—8:19
    - 5. The fourth, fifth, and sixth plagues 8:20—9:12
    - 6. The seventh, eight, and ninth plagues 9:13—10:29
    - 7. The proclamation of the tenth plague ch. 11
  - C. God's redemption of His people 12:1—13:16
    - 1. The consecration of Israel as the covenant nation 12:1-28
    - 2. The death of the firstborn and the release of Israel 12:29-36
    - 3. The exodus of Israel out of Egypt 12:37-42
    - 4. Regulations concerning the Passover 12:43-51
    - 5. The sanctification of the firstborn 13:1-16
  - D. God's completion of Israel's liberation 13:17—15:21
    - 1. The journey from Succoth to Etham 13:17-22
    - 2. Israel's passage through the Red Sea ch. 14
    - 3. Israel's song of deliverance 15:1-21
- II. The adoption of Israel 15:22—40:38
- A. God's preparatory instruction of Israel 15:22—18:27
    - 1. Events in the wilderness of Shur 15:22-27
    - 2. Quails and manna in the wilderness of Sin ch. 16
    - 3. The lack of water at Rephidim 17:1-7
    - 4. The hostility of the Amalekites 17:18-36
    - 5. The friendliness of Jethro the Midianite ch. 18
  - B. The establishment of the Mosaic Covenant 19:1—24:11
    - 1. Preparation for the Covenant ch. 19

2. The Ten Commandments 20:1-17
  3. The response of the Israelites 20:18-21
  4. The stipulations of the Book of the Covenant 20:22—23:33
  5. The ratification of the Covenant 24:1-11
- C. Directions regarding God's dwelling among His people 24:12—31:18
1. The revelation of these directions 24:12-18
  2. Contributions for the construction of the sanctuary 25:1-9
  3. The tabernacle furnishings 25:10-41
  4. The tabernacle structure ch. 26
  5. The tabernacle courtyard 27:1-19
  6. The investiture of the priests 27:20—28:43
  7. The consecration of the priests 29:1-37
  8. The service of the priests 29:38—30:38
  9. The builders of the tabernacle 31:1-11
  10. The sign of the Sabbath 31:12-18
- D. The breaking and renewing of the covenant chs. 32—34
1. The failure of Israel ch. 32
  2. The re-establishment of fellowship ch. 33
  3. The renewal of the covenant ch. 34
- E. The construction and dedication of the objects used in Israel's worship chs. 35—40
1. Preparations for construction 35:1—36:7
  2. Execution of the work 36:8—39:43
  3. The erection and consecration of the tabernacle ch. 40

In an interesting and original chart of Exodus, Ted Grove suggested the following structural outline of Exodus:<sup>1</sup>

- I. Israel's liberation chs. 1—18
  - A. Israel's affliction (Israel is Egypt's possession) 1:1—2:14

---

<sup>1</sup>Ted was a student in my Old Testament History I course in the spring of 1991.

B. Deliverance 2:15—18:27

Ted saw the following chiastic structure in 2:15—18:27.

A Midian: Moses' commission 2:15—4:28

B Enemy: Egypt defeated 4:29—15:21

C Water: bitter to sweet and 12 springs 15:22-27

D Food: manna and quail ch. 16

C' Water: out of rock 17:1-7

B' Enemy: Amalek defeated 17:8-16

A' Midian: Moses accepts wisdom ch. 18

II. Israel's adoption chs. 19—40

A. Covenant delivered 19:1—24:11

B. Sanctuary planned 24:12—31:18

C. Covenant broken ch. 32

D. Covenant renewed chs. 33—34

E. Sanctuary's construction 35:1—40:33

F. Covenant sealed (Israel is God's possession) 40:34-38

Ted also saw a chiasm in chapters 19—40:

A Covenant delivered 19:1—24:11

B Tabernacle planned 24:12—27:21

C Priestly instructions chs. 28—30

D Craftsmen's direction 31:1-11

E Sabbath instructions 31:12-18

F Covenant broken ch. 32

F' Covenant renewed chs. 33—34

E' Sabbath reminded 35:1-3

D'     Craftsmen and construction 35:4—38:31

C'     Priests prepared ch. 39

B'     Tabernacle completed 40:1-33

A'     Covenant sealed 40:34-38

The center of the first chiasm is the "manna." The center of the second chiasm is the "tablets (covenant) of the Law." These were the two items God instructed Moses to preserve in the ark of the covenant. Ted saw the key verse of the book as 34:9.

### MESSAGE

The great contribution of this book is the revelation that Yahweh is the sovereign God who provides deliverance for man from the slavery in which he finds himself.

The major teaching of Exodus is primarily threefold: the sovereignty of God, the salvation of man, and the methods by which the sovereign God affects man's salvation.

First, Exodus teaches the *sovereignty of God*.

In Genesis, we learn that the only way we can realize the purpose for which God created us, is through faith in a trustworthy God that expresses itself in obedience. In Exodus, we learn that the God with whom we can have a relationship is not only trustworthy, but also sovereign. This realization should produce within us the double effect of worship and obedience.

"Sovereignty" is the attribute of God that expresses the fact that Yahweh is the ultimate ruler of the universe. There is no one higher in authority than He. As Sovereign, He has *all power*. Sovereignty does not refer to *how* God rules, the method by which He governs. In particular, it does not imply that God controls every detail of life immediately (directly). God exercises His sovereignty by allowing human beings certain freedoms. He does not control people like puppets on strings, but as a father controls his children. We have freedom, but within certain limits. A biblical definition of sovereignty is very important.



"Sovereignty is not a property of the divine nature, but a prerogative arising out of the perfections of the Supreme Being. If God be a Spirit, and therefore a person, infinite, eternal, and immutable in his being and perfections, the Creator and Preserver of the universe, He is of right its absolute sovereign."<sup>1</sup>

We can see God's sovereignty clearly in His superiority over all the so-called gods of Egypt. He displayed His great power in all of His activity (miracles and 10 plagues), that resulted in the liberation of the Israelites, and His adoption of them as His special people. Scripture teaches both the sovereignty of God and the responsibility of man. No one has been able to explain this mystery to the satisfaction of all of God's people, but the Scriptures clearly teach both truths.

Second, Exodus teaches the *salvation of man*.

In Genesis, we see the *need* for salvation (i.e., the Fall and the repeated failures of mankind). Even people of faith need salvation (deliverance). In Exodus, God initially revealed His method of salvation and explained the consequences of salvation. Exodus teaches that God provides salvation for man. Man does not provide it for himself. It also reveals that man appropriates what God has provided by faith.

Two activities become prominent as major expressions of faith in Exodus: worship and obedience. Worship and obedience are the God-ward and the man-ward expressions of faith, respectively. They are the opposite of idolatry and self-assertiveness—two characteristics that are prominent in Genesis. God's instruction for Israel's obedience was the Mosaic Law. His instruction for her worship was the tabernacle. Much of Exodus deals with the Mosaic Law and the tabernacle.

True worship includes putting God at the center of life (cf. Rom. 6:12-13; 12:1-2). Worship was to characterize the Israelites nationally and personally. God illustrated the importance of placing Him at the center of life by locating the ark of the covenant in the center of the tabernacle, and by placing the tabernacle in the center of the Israelite camp. Obedience consists of arranging all the parts of life in proper relation to God, who is at the center. If something in life does not orient toward God properly,

---

<sup>1</sup>Charles Hodge, *Systematic Theology*, 1:440.

there is disobedience. In this way, Exodus deepens the revelation concerning obedience that God gave in Genesis.

Third, Exodus teaches the *methods* by which the sovereign God affects man's salvation:

God's method of dealing with *the human race generally* (outside Israel) was by creating a pattern, namely, the nation of Israel. God created the nation of Israel so He could demonstrate through Israel, for all other nations and peoples to see, how glorious it can be to live under God's government. God's election of Israel was not the selection of a pet that God would favor at the expense of all others. It was the construction of a pattern. Israel was to be a demonstration to all the world of how wonderful life can be under the rule of Sovereign Yahweh (cf. 19:5-6).

God's method of dealing with *Israel* was by revealing a person, namely, Himself. In many revelations to the Israelites, God sought to deepen their understanding of, and appreciation for, Himself and His will. The special privilege of receiving this revelation was a blessing to them, and should have resulted in their being a blessing to the whole world. Israel was to do this by demonstrating how good it is to live under God's kingship.

Some of the most important revelations of God occur in the following passages: 3:4-16; 6:2-8; 19:3-6; 20:1-7; 24:1, 9-11; 34:5-8; and 40:34-35. They are not all different, but God intended them to have the cumulative effect of enriching the Israelites' concept of Himself. They came to the people like waves beating on the shore. All the details of the Mosaic Code, which begins in Exodus and continues through Numbers, reinforce the main point of this revelation, which is the character of God. Look for this revelation as you read Exodus 20—Numbers 10.

God's method of dealing with *individuals* was by providing opportunities and choices. We can see this most easily in God's dealings with the two major characters in Exodus: Moses and Pharaoh. God's method of dealing with both men was the same, but their responses were different and, consequently, so were their fates.

Pharaoh was a strong, worldly-wise leader who acted wholly by sight rather than by faith in Yahweh. He is typical of people of the world. God's method of dealing with him was to give him opportunities to make the right choices, and so experience the blessing of God. Pharaoh chose not to trust God, and

his disobedience resulted in personal tragedy for himself and national tragedy for Egypt, which he led.

Moses, on the other hand, was also a strong, wise leader, but he acted by faith rather than by sight—eventually (Heb. 11:27). God's method of dealing with him, in Exodus, was the same as His method of dealing with Pharaoh. That is, He gave Moses opportunities to make the right choices, and so experience God's blessing. Moses chose to trust and obey God, and his life is a story of personal triumph and national triumph for Israel, which he led.

In both cases, God patiently worked with these representative individuals, and gently encouraged them to do His will. Moses developed into a noble character, because he chose to submit to God's authority, even though he was faulty, fearful, and failing. Pharaoh was a more admirable person in some worldly respects, but he sank into destruction, because he chose to refuse to submit to God's authority.

Exodus teaches that individuals are personally responsible under God, and their choices determine their destinies. There is ample New Testament evidence for this in John 1:12; 3:16, 36; 5:24; 6:29, 40, 47; 20:31; et al. Divine sovereignty does not negate human responsibility. Charles Haddon Spurgeon is reported to have said about the sovereignty/freedom paradox: "I never try to reconcile friends." These revelations harmonize.

My father was a very wise man, as well as being in a place of authority over me as my father. He gave me a certain amount of freedom, but he still controlled me. He knew how to "push my buttons." God does the same thing with us, only perfectly.

Many people, including many Christians, try to understand divine revelation (the Bible) within the parameters of human reason. They filter what the Bible says through the grid of what they understand to be true and reasonable. This approach has led many people to reject the Bible, or parts of the Bible, as unreasonable, illogical, or unscientific.

The other option is to let revelation sit in judgment on what is reasonable (cf. 1 Cor. 1:25). This is the approach of faith. (Really, both positions are faith positions. We either have faith in what is generally accepted as true, or we have faith in what God has said is true.) I am not suggesting that we should stop using our minds when reading and interpreting Scripture, but

we should filter all information through the grid of Scripture. This is what Paul was talking about when he wrote about renewing our minds (Rom. 12:2). Essentially the question is, "Which is more reliable: revelation or reason?" We believe revelation is, because it is the Word of God.

God, in His infinite wisdom and knowledge, has revealed only a portion of total reality. Human beings, in our fallen finiteness and limited understanding, can only understand a portion of what He has revealed, not all of reality. God has made His revelation available to people in nature and in Scripture. In nature, He has revealed His power and deity—so much so that every human being with normal mental powers can see that there is a God (Ps. 19; Rom. 1). In Scripture, God has revealed His plan of salvation. Trying to fit all of revelation into a rational system is an exercise in futility. It is like trying to pour the Pacific Ocean into a one-gallon jug. Therefore we must humble ourselves before God, and submit our reasons to His revelation, rather than living the other way around.

If we look at the record of *God's* activity in Exodus, we see progress. The unbelief of His enemies does not frustrate Him. His ultimate purposes for Israel came to fruition. However, if we look at the record of *man's* activity in this book, we see failure. Even Moses, Aaron, and the Israelites, who trusted God, repeatedly failed. We observe this in the lives of the characters in Genesis as well.

While man constantly falls short of what God requires, human failure does not frustrate God's ultimate purposes. This proves that God is indeed sovereign.

In Genesis, we see the importance of *faith* in God for success in life. In Exodus, we see that true faith manifests itself in *worship* of God and *obedience* to God.<sup>1</sup>

---

<sup>1</sup>Adapted from G. Campbell Morgan, *Living Messages of the Books of the Bible*, 1:1:29-45.

## Exposition

### I. THE LIBERATION OF ISRAEL 1:1—15:21

"The story of the first half of Exodus, in broad summary, is Rescue. The story of the second half, in equally broad summary, is Response, both immediate response and continuing response. And binding together and undergirding both Rescue and Response is Presence, the Presence of Yahweh from whom both Rescue and Response ultimately derive."<sup>1</sup>

"In recent years a popular theological movement, both in American and Latin American countries, has been 'liberation theology.' This is no mere academic movement. In fact, most Americans who are tuned in to their culture can see occasional, albeit veiled, references to it. Although there are differing nuances of liberation theology (varying from theologian to theologian or from issue to issue), what they all have in common is the notion that God is, without qualification, on the side of the oppressed and that relief from oppression is the true goal of all Christian work. ...

"Liberation theology tends to overlook the real purpose for which Israel was delivered. Moses does not say, 'Let my people go,' but 'Let my people go, *so that they may worship me in the desert*' (7:16)."<sup>2</sup>

### A. GOD'S PREPARATION OF ISRAEL AND MOSES CHS. 1—4

#### 1. The growth of Jacob's family 1:1-7

The purposes of this section are three at least:

---

<sup>1</sup>Durham, p. xxiii.

<sup>2</sup>Peter Enns, *Exodus*, pp. 143-44. For an introduction to Liberation Theology, see Wolf, pp. 130-31.

1. These verses introduce the Israelites ("sons of Israel") who are the focus of attention in Exodus.
2. They also tie the Israelites back to Jacob, and explain their presence in Egypt.
3. This section also accounts for the numerical growth of the Israelites, during the 360 years that elapsed between Genesis and Exodus, following Joseph's death and preceding Moses' birth.

Moses used the rounded number "70" for the total number of Jacob's descendants when the patriarch entered Egypt (v. 5; cf. Gen. 46:27).<sup>1</sup> His purpose was to contrast the small number of Israelites that entered Egypt, with the large number that existed when Moses was born, which was about two million individuals (cf. 12:37; 38:26; Num. 1:45-47). It is quite easy to prove mathematically that Jacob's family of 70 that moved into Egypt, could have grown into a nation of two million or more individuals in 430 years.<sup>2</sup>

The fruitfulness (prosperity and fast growth) of the Israelites in Goshen, and their vast increase in number ("multiplied"), was due to God's blessing, as He was fulfilling His promises to the patriarchs (v. 7; cf. Gen. 22:17; 32:12).

## 2. The Israelites' bondage in Egypt 1:8-22

This pericope (section of verses) serves a double purpose: It introduces the rigorous, slave-driving conditions under which the Egyptians forced the Israelites to live, and it sets the stage for the birth of Moses.

1:8-14 The "new king" referred to (v. 8) may have been Ahmose (Gr. *Amosis*), who founded the eighteenth dynasty and the New Kingdom Period, and ruled from 1570 to 1546 B.C.<sup>3</sup> However,

---

<sup>1</sup>For good, short histories of Egypt, see Hannah, pp. 105-7; Youngblood, pp. 20-25, or Siegfried Schwantes, *A Short History of the Ancient Near East*, pp. 51-109. For a brief history of Egypt through the time of David and Solomon, see Charles H. Dyer and Gregory A. Hatteberg, *The New Christian Traveler's Guide to the Holy Land*, pp. 158-64.

<sup>2</sup>See Ralph D. Winter, "The Growth of Israel in Egypt (The Phenomenon of Exponential Growth)," a paper published by the Institute of International Studies, Pasadena, Ca., 14 April 1993.

<sup>3</sup>Joseph P. Free, *Archaeology and Bible History*, p. 84.

he was probably one of Ahmose's immediate successors: Amenhotep I, or, most likely, Thutmose I. (This was not the famous Tutankhamen, King Tut, who ruled Egypt from 1360 to 1351 B.C., during the Judges Period of Israel's history. Nor was he the much-later Pharaoh who was confronted by Moses and given the famous ultimatum, "Let My people go.")

However, the identity of this new king, Israel's oppressor, was not important enough for the writer to identify by name. His emphasis was rather on the oppression of the Israelites, the awful condition out of which God would redeem His people.

Leon Wood and John Rea argued that this king was one of the Hyksos rulers.<sup>1</sup> Ahmose was the first native Egyptian Pharaoh after many years of Hyksos rule.

Preceding Ahmose was a series of Hyksos rulers.<sup>2</sup> The name Hyksos probably means "rulers of foreign lands,"<sup>3</sup> though the ancient Egyptian historian Manetho wrote that it meant "shepherd-kings."<sup>4</sup> The Hyksos were a Semitic people from the northern part of the Fertile Crescent—from the area around Paddan-aram, where Laban, Leah, and Rachel originally lived (cf. Gen. 48:7).

"Aryan [people speaking an Indo-European language] elements were discovered among the Hyksos, who founded a great empire in Syria and for many years held Egypt."<sup>5</sup>

The Hyksos had invaded Egypt about 1670 B.C., and they ruled until Ahmose expelled them. The New Kingdom Period (ca.

---

<sup>1</sup>Leon J. Wood, *A Survey of Israel's History*, pp. 34-38; John Rea, "The Time of the Oppression and the Exodus," *Journal of the Evangelical Theological Society* 3 (1960):59-61.

<sup>2</sup>See Aharon Kempinski, "Jacob in History," *Biblical Archaeology Review* 14:1 (January-February 1988):42-47.

<sup>3</sup>John Van Seters, *The Hyksos*, p. 187.

<sup>4</sup>Cited by Flavius Josephus, *Against Apion*, 1:14. See also Jack Finegan, *Light from the Ancient Past*, p. 94.

<sup>5</sup>A. T. Olmstead, *History of the Persian Empire*, p. 11.

1570-1085 B.C.) that Ahmose inaugurated was the period of greatest imperial might in Egypt's long history.

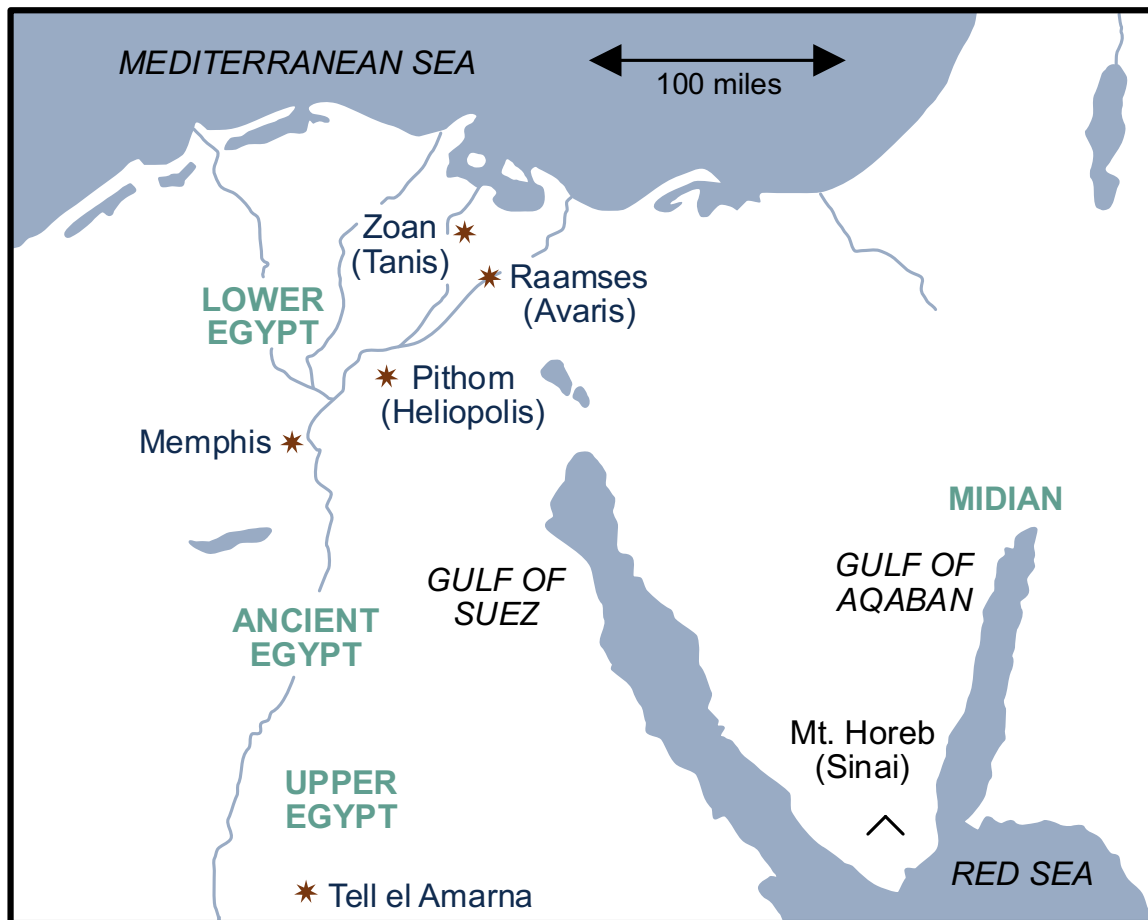

To summarize, Jacob moved from Canaan to Egypt about 1876 B.C., during the reign of Pharaoh Senusert III (Sesostris, ca. 1878-1871).<sup>1</sup>

"His predecessor, Senusert II (1894-1878), would have been the man whose dream Joseph interpreted and who made Joseph his vizier."<sup>2</sup>

The Hyksos invaded Egypt about 1670, approximately 200 years after Jacob relocated there. Ahmose expelled the Hyksos about 1570, ending their 100-year domination of Egypt.

<sup>1</sup>Wood, pp. 113-14.

<sup>2</sup>Ibid., p. 114.



Moses was born about 1525, or about 50 years after Ahmose had restored Egyptian sovereignty.

"In the Late Bronze Age [ca. 1500-1200 B.C.], Egypt entered her period of Empire, during which she was unquestionably the dominant nation of the world. Architects of the Empire were the Pharaohs of the Eighteenth Dynasty, a house that was founded as the Hyksos were expelled from Egypt and that retained power for some two hundred and fifty years (ca. 1570-1310), bringing to Egypt a strength and a prestige unequalled in all her long history."<sup>1</sup>

The title Pharaoh means "Great House." It originally designated the Egyptian king's residence and household. It became a title for the king himself, for the first time, in the eighteenth dynasty.<sup>2</sup>

The implication of the statement that Pharaoh "did not know Joseph," in the Hebrew text, is that he did not know him because he did not want to know about him (v. 8). It seems that the early kings of the eighteenth dynasty wanted to solidify control of Egypt in the hands of native Egyptians. After a long period of control by foreigners, they did not want to acknowledge the greatness of Joseph, who was, of course, also a foreigner and a Semite.

"Forgetfulness of Joseph brought the favour shown to the Israelites by the kings of Egypt to a close."<sup>3</sup>

---

<sup>1</sup>John Bright, *A History of Israel*, p. 98.

<sup>2</sup>Walter C. Kaiser Jr., "Exodus," in *Genesis-Numbers*, vol. 2 of *The Expositor's Bible Commentary*, p. 288.

<sup>3</sup>C. F. Keil and Franz Delitzsch, *Biblical Commentary on the Old Testament: Pentateuch*, 1:421.

### Identifications of Significant Pharaohs after Joseph and in Exodus<sup>1</sup>

SECOND INTERMEDIATE PERIOD (dynasties 15-16; ca. 1674-1567 B.C.). Capital: Avaris (Raamses). Period of Hyksos rule.

NEW KINGDOM (dynasties 17-20; ca. 1570-1085 B.C.). Capital: Tanis (Zoan). Period of imperial supremacy.

**Ahmose** (Amosis; 1570-1546 B.C.; 1st Pharaoh of 18th dynasty) expelled the Hyksos and re-established native Egyptian rule.

**Amenhotep I** (1546-1526 B.C.; 2nd Pharaoh of 18th dynasty)

**Thutmose I** (Thutmosis I; 1525-ca. 1512 B.C.; 3rd Pharaoh of 18th dynasty) practiced genocide on Hebrew male babies (Exod. 1:15-22).

**Hatshepsut** (1503-1482 B.C.; 5th Pharaoh of the 18th dynasty) was the daughter of Pharaoh Thutmose I who drew Moses out of the Nile and later ruled as Queen (Exod. 2:5).

**Thutmose III** (1504-1450 B.C.; 6th Pharaoh of the 18th dynasty) was the Pharaoh of the oppression who tried to kill Moses and from whom Moses fled into Midian (Exod. 2:15).

**Amenhotep II** (1450-1425 B.C.; 7th Pharaoh of the 18th dynasty) was the Pharaoh of the plagues and the Exodus (Exod. 3:10—15:19).

Pharaoh Thutmose I launched three successive plans to reduce the threat of the sizable Hebrew population that had then become larger and stronger than the Egyptian ruling class (v. 9).

The first plan (plan A) was to make the Hebrews toil hard in manual labor. Normally a population grows more slowly under oppression than in prosperous times. However, the opposite took place in the case of the Israelites ("the more they oppressed them, the more they multiplied," v. 12). Physical

---

<sup>1</sup>Based on the *Cambridge Ancient History*. All identifications are probable. See also Finegan, ch. 2: "The Panorama of Egypt."

oppression also tends to crush the spirit, and in this objective the Egyptians were somewhat successful (2:23-24).

An expanded translation of verse 10 could read as follows: "Come, let us [the entire Egyptian ruling class] deal shrewdly with them [the Israelites], otherwise they will multiply, and in the event of war [with enemies: the Hyksos, or any others], they will also join with those who hate us, and fight against us and depart from the land."<sup>1</sup>

"Thutmose I was involved in enlarging Egypt's borders, which meant that most of his army was out of the country for extensive periods of time. He did not want this foreign people to increase and become still a greater threat while his home force was so small."<sup>2</sup>

This plan remained in effect for some time. It probably took years to build the cities of Pithom and Raamses (also spelled Ramses and Rameses), which the Egyptians used to store goods ( cf. 1 Kings 9:19; 2 Chron. 8:6; 17:12). Pithom may be identified as Tell el Maskhuta, Tell er-Retabeh, or Heliopolis, instead of Tanis; and Raamses may have been Qantir or Tanis, rather than Tell el-Maskhota, the popular critical identifications.<sup>3</sup> These Israelites built cities, not the pyramids, some of which stood even back in Abraham's day.

"Ruins of great brick buildings are found in all parts of Egypt."<sup>4</sup>

---

<sup>1</sup>See Gleason L. Archer Jr., "Old Testament History and Recent Archaeology from Abraham to Moses," *Bibliotheca Sacra* 127:505 (January-March 1970):24-25.

<sup>2</sup>Wood, p. 116.

<sup>3</sup>See Longman and Dillard, p. 67; Kaiser, "Exodus," p. 289; Free, pp. 85-86; Charles F. Aling, "The Biblical City of Ramses," *Journal of the Evangelical Theological Society*, 25:2 (June 1982):128-37.

<sup>4</sup>Robert Jamieson, A. R. Fausset, and David Brown, *Commentary Practical and Explanatory on the Whole Bible*, p. 54.

According to Josephus, the Israelites also dug many channels for the Nile.<sup>1</sup>

"The name 'Rameses' for one of the store cities seems to point unquestionably to Rameses II [ca. 1300-1234 B.C.]. But it is probable that this city, which already existed under the Hyksos (the foreigners who ruled Egypt several centuries before the nineteenth dynasty), was rebuilt by Rameses II and that 1:11 refers to the city by its later name ..."<sup>2</sup>

Some scholars believe that there are several instances of the writer, or a later editor, using more modern names for older sites in the Pentateuch. Other scholars have offered other explanations, and I have tried to point these out where they occur.

"The brick was the staple of Egyptian architecture, as only the temples and palaces were constructed of stone."<sup>3</sup>

This first plan failed to reduce the threat that the Israelites posed to Pharaoh, so the Egyptians then adopted a second approach.

1:15-22 Plan B consisted of ordering the Hebrew midwives to kill all the male Hebrew babies at birth. Shiphrah means "Beautiful One," and Puah means "Splendid One." William Albright confirmed that these women's names were Semitic.<sup>4</sup> Evidently these two women were officials in the Egyptian government who were responsible for all the midwives, since it would be impossible for only two women to personally oversee all Hebrew births.

---

<sup>1</sup>Flavius Josephus, *Antiquities of the Jews*, 2:9:1. Josephus reflected some traditional Jewish traditions and should not be considered completely reliable.

<sup>2</sup>William H. Gispem, *Exodus*, p. 22. Cf. Wolf, pp. 143-45. See also my note on Gen. 47:11.

<sup>3</sup>F. B. Meyer, *Devotional Commentary on Exodus*, p. 19.

<sup>4</sup>W. F. Albright, "Northwest-Semitic Names in a List of Egyptian Slaves from the Eighteenth Century B.C.," *Journal of the American Oriental Society* 74 (1954):233. See also Finegan, pp. 93-94.

"They were to kill them, of course, secretly, in such a way that the parents and relatives would be unaware of the crime, and would think that the infant had died of natural causes either before or during birth."<sup>1</sup>

"Infanticide was commonly practiced by the nations of antiquity."<sup>2</sup>

As I mentioned, plan A (vv. 9-14) may have been in effect for several years. Because of the chronology of Moses' life, many evangelical commentators have felt that the Pharaoh the writer referred to in verses 15-22 was Ahmose's successor: Amenhotep I (1546-1526 B.C.). More likely, though, he was the man who followed Amenhotep I: Thutmose I (1525-ca. 1512 B.C.).<sup>3</sup>

"Although the biblical term 'Hebrew' [v. 15] is probably cognate to the similar word *'apiru* (found in Egyptian, Babylonian, and Canaanite texts), the latter was applied to a population element that was ethnically diverse and that had in common only a generally inferior social status. The word 'Hebrew' is almost always used by Gentiles to distinguish Israelites ethnically from other peoples and apparently denotes descent from Eber (Gen. 10:24-25; 11:14-17), whose ancestor was Noah's son Shem (Gen. 10:21)."<sup>4</sup>

Ancient Near Easterners preserved national identity through the males, and it is for this reason that Pharaoh ordered the baby boys' deaths. In contrast, modern Jews trace their ethnic identity through their mother. This change evidently took place during the Middle Ages. One writer suggested that

---

<sup>1</sup>Umberto Cassuto, *A Commentary on the Book of Exodus*, p. 12.

<sup>2</sup>Meyer, p. 20.

<sup>3</sup>See Davis, p. 51.

<sup>4</sup>Youngblood, p. 27.

Pharaoh spared the girls, "perhaps to serve later as harem girls."<sup>1</sup>

The midwives' fear of God (Elohim, vv. 17, 21) led them to disobey Pharaoh's command to practice genocide. They chose to "obey God rather than men" (cf. Acts 5:29). Pharaoh's order contradicted a fundamental divine command (cf. Gen. 1:28; 9:1, 7). All life belongs to God, so He is the only person who has the right to take it, or to command when others should take it. The midwives' fear of God resulted in their having reverence for human life. Their explanation of their actions ("the Hebrew women ... give birth before the midwife can get to them," v. 19) may have been completely truthful, or it may not have been entirely truthful.

"Even though these women lied to Pharaoh (which the Bible, as is often the case, does not stop to specifically condemn at this point), they are praised for their outright refusal to take infant lives."<sup>2</sup>

God blessed these women with families of their own ("established households for them," v. 21), in spite of their deceit, if they practiced it, because they feared God.

This second plan "miscarried" too.

The intent of plan C was also to do away with the male Hebrew babies (v. 22). However, instead of relying on the Hebrew midwives, Pharaoh called on all his subjects to throw every Hebrew boy that was born into the Nile River. Since the Egyptians regarded the Nile as a manifestation of deity, perhaps Pharaoh was making obedience to his edict an act of worship for the Egyptians. This plan evidently failed too. The Egyptians do not appear to have cooperated with Pharaoh. Even Pharaoh's daughter did not obey this command (2:6-8). This plan, too, may very well have continued in effect for a long time.

---

<sup>1</sup>Gispen, p. 36.

<sup>2</sup>Kaiser, "Exodus," p. 306. Cf. Josh. 2:4-6.

"The central idea [in this pericope] is that God faithfully fulfills His covenant promises in spite of severe and life-threatening opposition. Even Pharaoh, the most powerful man on earth could do nothing to thwart God's purpose. In fact, God actually used Pharaoh's opposition as a means of carrying out His promises."<sup>1</sup>

"It is interesting to note that the author has placed two quite similar narratives on either side of his lengthy treatment of the Exodus and wilderness wanderings. The two narratives are Exodus 1—2, the Egyptian king's attempt to suppress Israel, and Numbers 22—24, the Moabite king's attempt to suppress Israel. Both narratives focus on the futility of the nations' attempts to thwart God's plan to bless the seed of Abraham ..."<sup>2</sup>

"The Lord rules despite appearances."<sup>3</sup>

"The suffering of Abraham's descendants in Egypt (Exodus 1) was not a direct result of any sin... Not all suffering should be seen as God's displeasure, and there is the possibility of blessing in the midst of suffering as part of God's plan."<sup>4</sup>

### **3. Moses' birth and education 2:1-10**

"Whilst Pharaoh was urging forward the extermination of the Israelites, God was preparing their emancipator."<sup>5</sup>

"... among other things, the Pentateuch is an attempt to contrast the lives of two individuals, Abraham and Moses. Abraham, who lived before the law (*ante legem*), is portrayed as one who kept the law [Gen. 26:5], whereas Moses, who lived

---

<sup>1</sup>Gordon H. Johnston, "I Will Multiply Your Seed [Exodus 1]," *Exegesis and Exposition* 1:1 (Fall 1986):27.

<sup>2</sup>John H. Sailhamer, *The Pentateuch as Narrative*, p. 242.

<sup>3</sup>Enns, p. 50.

<sup>4</sup>Stephen J. Bramer, "Suffering in the Pentateuch," in *Why, O God? Suffering and Disability in the Bible and the Church*, p. 93.

<sup>5</sup>Keil and Delitzsch, 1:426.

under the law (*sub lege*), is portrayed as one who died in the wilderness because he did not believe [Num. 20:12]."<sup>1</sup>

2:1-5 The names of Moses' parents were Amram and Jochebed (6:20). Amram was apparently the sixth generation from Abraham, of "the house [tribe] of Levi," and Moses was the seventh (v. 1; 1 Chron. 6:1-2). However, the genealogies in Scripture are frequently selective and incomplete, so I cannot be dogmatic about these numbers of generations.

"At this point Scripture's aim is to inform us that from an ordinary man, ... and from an ordinary woman, ... whose names there was no need to mention [at this point], God raised up a redeemer unto his people."<sup>2</sup>

It is not clear from the text if Moses was an unusually "beautiful" child physically, or if he was distinctive in some other respect (v. 2). The phrase used to describe him in Hebrews 11:23, as well as the Hebrew word used here, *tob*, can have a broader meaning than physical beauty. Some English versions translate *tob* "fine" (NRSV, ESV, NIV, TNIV, NEB), "goodly" (AV), "healthy" (NET2), as well as "beautiful" (NASB, NKJV, HCSB, CEV).<sup>3</sup>

This description of Moses as *tob* reminds us of Genesis 1:4, 10, 12, 18, 21, 25, and 31, where Moses used the same Hebrew word to describe God's creation as "good." Thus we

---

<sup>1</sup>John H. Sailhamer, "The Mosaic Law and the Theology of the Pentateuch," *Westminster Theological Journal* 53 (Fall 1991):243.

<sup>2</sup>Cassuto, p. 17.

<sup>3</sup>The versions cited are, respectively: *The Holy Bible: New Revised Standard Version*, 1989 ed.; *The Holy Bible: English Standard Version*, 2001 ed.; *The Holy Bible: New International Version*, 1984 ed.; *The Holy Bible: Today's New International Version*, 2005 ed.; *The New English Bible with the Apocrypha*, 1970 ed.; *The Holy Bible: Authorized King James Version*, *The NET2 (New English Translation) Bible*, 2019 ed.; *The New American Standard Bible*, 2020 ed.; *The Holy Bible: New King James Version*, 1982 ed.; and *The Holy Bible: Holman Christian Standard Bible*, 2004 ed.; *The Holy Bible: Contemporary English Version*, 1995 ed. See also Brevard Childs, *The Book of Exodus*, p. 18; J. Vernon McGee, *Thru the Bible with J. Vernon McGee*, 1:205.



see that in the birth of Moses God also created something that was "good," as time would tell.

Josephus claimed that God had revealed to Amram in a dream that Moses would humble the Egyptians.<sup>1</sup> There is no scriptural support for this tradition. It may or may not be true.

Jochebed and Amram hid Moses because they trusted God (Heb. 11:23-26). The same Hebrew word translated "papyrus basket" in this verse (*tehvah*) reads "ark" or "boat" in most English translations of Genesis 6:14. As Noah's ark was God's instrument for preserving one savior of the human race, Moses' ark proved to be His means of preserving another savior of the Israelites.

"Ironically Jochebed, putting her son into the Nile, was in one sense obeying the Pharaoh's edict to 'throw' baby boys into the river! (Ex. 1:22)"<sup>2</sup>

"There is abundant warrant, afforded by this narrative, for Christian parents to cast their children upon God."<sup>3</sup>

Moses' older sister was probably Miriam. She is the only sister of Moses mentioned in Scripture (v. 4; Num. 26:59; 1 Chron. 6:3).

The daughter of Pharaoh was probably Hatshepsut, who was a very significant person in Egyptian history (v. 5).<sup>4</sup> Josephus identified her as Thermuthis.<sup>5</sup> She later assumed co-regency with Thutmose III, and ruled as the fifth Pharaoh of the eighteenth dynasty (1503-1482 B.C.). The ruling class in Egypt was male-dominated, and it took a very forceful woman to rise politically and rule. Queen Hatshepsut adopted certain male mannerisms to minimize objections to her rule, including

---

<sup>1</sup>Josephus, *Antiquities of ...*, 2:9:3.

<sup>2</sup>Hannah, p. 109.

<sup>3</sup>Meyer, p. 26.

<sup>4</sup>See Finegan, pp. 97-98; Wood, pp. 117-19; Free, p. 86, n. 9.

<sup>5</sup>Josephus, *Antiquities of ...*, 2:9:5.

the wearing of a false beard that appears on some Egyptian pictures of her.<sup>1</sup>

"God often raises up friends for his people even among their enemies."<sup>2</sup>

It was not uncommon for Pharaohs and other Egyptians to bathe ceremonially in the sacred Nile River, as many Indians do today in the Ganges River. The Egyptians believed that the waters of the Nile possessed the ability to impart fruitfulness and to prolong life.

Several women were involved in the events surrounding Moses' birth: the midwives, Pharaoh's daughter, her maid, Moses' sister, and Jochebed. How ironic it was that women, whom Egyptian and Israelite men looked down on as less significant than themselves, should have been responsible for saving Israel's savior! Truly the hand of God is evident in the affairs of Moses' preservation. The Gospel writers also recorded that several women ministered to Jesus Christ, the Savior of the world, during His first advent.

2:6-10 As the adopted son of Pharaoh's daughter, Moses enjoyed the highest privileges in his education. Commenting on Moses' training, Stephen said that he became "proficient in speaking and action" (Acts 7:22). Josephus wrote that Moses was "a general" in the Egyptian army that defeated the Ethiopians, and that he married the daughter of the king of Ethiopia.<sup>3</sup> We cannot prove the accuracy of this statement, but it suggests that Moses may have risen high in Egyptian society before he fled Egypt.

The nature of God's deliverance is sometimes surprising and unexpected. God's deliverance of Moses prefigures His surprising and unexpected deliverance of the Israelites (cf. Rom. 8:28).

---

<sup>1</sup>See Merrill F. Unger, *Archaeology and the Old Testament*, pp. 144-45; Francis Nichol, ed., *The Seventh-Day Adventist Bible Commentary*, 1:502.

<sup>2</sup>Matthew Henry, *Commentary on the Whole Bible*, p. 73.

<sup>3</sup>Josephus, *Antiquities of ...*, 2:10:1-2.

Moses' name was probably Egyptian, but "Moses" became a popular Hebrew name. It relates obviously to the names of other great Egyptians of that period (e.g., Ahmose, Thutmose, et al.). The "mose" part of the name means "is born" or "one born of," and "mo" means "water."<sup>1</sup> Moses' name may have been longer, and may have had some connection with the name of an Egyptian god, as the other "mose" compound names referred to above did. If this was the case, in refusing to be called the son of Pharaoh's daughter (Heb. 11:24), Moses was actually refusing reference to an Egyptian deity."<sup>2</sup>

Josephus quoted Manetho, an ancient Egyptian historian, as follows:

"... he [Moses] was by birth of Heliopolis; and his name was Osarsiph, from Osiris, the god of Heliopolis, but ... he changed his name, and called himself Moses."<sup>3</sup>

Moses' name became prophetic.

"The one who was drawn out of water would be the means of drawing the Israelite nation out of water [i.e., the waters of the Red Sea]."<sup>4</sup>

"The phrase 'drew him out' (v. 10) is a Hebrew pun on the name, emphasizing the baby's rescue from the waters of the Nile."<sup>5</sup>

Ancient Near Easterners regarded the waters of the sea to be a very hostile enemy, because they could not control them. The Egypt of Moses' day was this kind of hostile foe for the Israelites.

---

<sup>1</sup>See Finegan, p. 134.

<sup>2</sup>Nichol, 1:504.

<sup>3</sup>Josephus, *Against Apion*, 1:28; cf. 1:26, 29. Josephus was critical of Manetho as a historian, however.

<sup>4</sup>*The Nelson Study Bible*, p. 101.

<sup>5</sup>Youngblood, p. 30.

"Moses' birth story is just one example of a common Old Testament theme. At various crucial junctures the birth of a child is instrumental to God's plan of delivering his people from some dire situation [cf. the births of Isaac, Obed (Ruth 4:21-22), Samson, Samuel, John the Baptist, and Jesus]."<sup>1</sup>

The fact that Moses later chose to identify with the Israelites, rather than the Egyptians, is remarkable in view of his Egyptian background and privileges. His parents must have had a strong influence on him beginning very early in his life (cf. Joseph). We should never underestimate the power of parental influence even early in life. Note too that the faith of a child can grow stronger when tested by an ungodly environment.

#### 4. Moses' flight from Egypt to Midian 2:11-15

Moses was "approaching the age of 40" (Acts 7:23) when he took his stand for his Hebrew brethren (v. 11). The reference to the Hebrew man as "one of his fellow Hebrews" suggests that Moses' motivation, in acting as he did, was love that sprang from faith in God's promises to the patriarchs. The writer of the Epistle to the Hebrews stated this motivation explicitly in Hebrews 11:26: "... considering the reproach of Christ greater riches than the treasures of Egypt; for he was looking to the reward."

Moses' desire to help his brethren was admirable, but his method was deplorable (v. 12; cf. Acts 7:23-29). He trusted in his own ability to liberate the Israelites, and sought to bring this about by natural means. He even resorted to sinful means, and seized authority, rather than waiting for God to give it to him.

"Moses looked this way, and he looked that way. Isn't it interesting? He didn't look *up*, did he?"<sup>2</sup>

"... there is in the [Hebrew] text no suggestion that Moses meant to kill the Egyptian, any more than that the Egyptian or the Hebrew man was attempting to kill his adversary."<sup>3</sup>

---

<sup>1</sup>Enns, p. 65.

<sup>2</sup>Charles R. Swindoll, *Moses: A Man of Selfless Dedication*, p. 43.

<sup>3</sup>Durham, p. 19. Cf. Warren W. Wiersbe, *The Bible Exposition Commentary/Pentateuch*, p. 182.

"You can never redress a nation's wrongs by offering brute force to brute force, or by a number of rash, violent acts."<sup>1</sup>

The Hebrew who rejected Moses' deliverance (v. 14) gave the typical reaction of the later Israelites to those whom God sent to deliver them (including Jesus): He rejected and opposed this "ruler" and "judge."

God had to teach Moses that he must not trust in his own ability, but instead rely on God's strategy and strength, and obey His commands. So God drove Moses out of Egypt, through the circumstances described here, to the land of Midian, where He proceeded to teach His servant these lessons. God gave Moses a B.D. degree (Backside of the Desert).<sup>2</sup> He made him "a ruler" and "a judge" (v. 14) eventually.

In this episode, Moses rescued an Israelite from an Egyptian who was beating him, but later he rescued all the Israelites from the Egyptians who were oppressing them (3:10).

"If the Hebrews had taken the hint, and come in to Moses as their head and captain, it is probable that they would have been delivered now; but, despising their deliverer, their deliverance was justly deferred, and their bondage prolonged forty years, as afterwards their despising Canaan kept them out of it forty years more."<sup>3</sup>

The Pharaoh referred to here was probably Thutmose III (v. 15; 1504-1450 B.C.), whose reign included a period of 21 years as co-regent with Hatshepsut.<sup>4</sup> Pharaoh probably tried to kill Moses by having him brought to justice through normal legal channels.

The land of Midian lay to the east of the Sinai Peninsula, and probably flanked the Gulf of Aqabah on both sides.<sup>5</sup> Moses ran a long way. The Midianites were descendants of Abraham through Keturah (Gen. 25:1-2).

---

<sup>1</sup>Meyer, p. 32.

<sup>2</sup>McGee, 1:200.

<sup>3</sup>Henry, p. 74.

<sup>4</sup>See Wood, p. 121; Free, p. 88.

<sup>5</sup>On the difficulty of locating Midian exactly, see Durham, p. 20.

Josephus wrote that Moses fled to "the city of Midian, which lay upon the Red Sea."<sup>1</sup> This does not seem to be correct.

"Midianites were employed in the copper mines of the Sinai Peninsula by Egyptian kings since the very first dynasties."<sup>2</sup>

"When the self-life has run its course, we settle in a desert. ... When the self-life finally sits down, the well of a new life lies near [cf. Ps. 46:10]."<sup>3</sup>

Moses' faith is obvious in his desire to identify with God and His people (cf. Ruth). He probably struggled in his younger years, with whether he could do more for the Israelites, by working for them within the Egyptian hierarchy, or without. It was Moses' faith in God that led him to give up Egypt (Heb. 11:24-26). He chose to identify with the faithful, and relied on the power of God—taking the role of a humble shepherd holding a staff, rather than on the power of an Egyptian prince holding a scepter.

Whereas Moses took matters into his own hands in Egypt and killed the Egyptian (v. 12), in Midian he took matters into his own hands and delivered Reuel's daughters and blessed their family (v. 19). Note the change in his character. In both cases he unconsciously anticipated his later role of deliverer of the Israelites.

God commands all who trust Him to separate from the world system that opposes and excludes Him (Rom. 12:2; et al.). This may or may not involve physical separation, depending on God's will for that individual. For Moses it involved physical separation, but for Joseph and Daniel it did not. The will of God is not the same for everyone in this respect.

## **5. Moses' life in Midian 2:16-25**

This section introduces some of the secondary characters in Exodus and sets the stage for Moses' call. Its purpose is primarily transitional.

Moses provided water for Jethro's daughters and their sheep in the wilderness (vv. 16-17). Forty years later, he provided water for God's people and their flocks in the wilderness (cf. 17:6; Num. 20:7-11). This was

---

<sup>1</sup>Josephus, *Antiquities of ...*, 2:11:1.

<sup>2</sup>Schwantes, p. 158.

<sup>3</sup>Swindoll, p. 49. Italics omitted.

the third time that Moses sought to deliver others from harm (v. 17; cf. vv. 12-13). Zipporah means "Bird."

As "the priest of Midian" (v. 16), Reuel ("Friend of God," v. 18) was the spiritual head of his branch of the Midianites. Moses' father-in-law had at least two names: Reuel (or Raguel, 2:18; Num. 10:29) and Jethro (or Jether, 3:1; 4:18; 18:1, 2, 5, 6, 9, 10, 12). Jethro (lit. "excellence") may have been his title and Reuel his given name.<sup>1</sup> He appears to have been a worshipper of the true God, like Melchizedek (cf. 18:12-23; Gen. 14:18-20). At this time, however, he may simply have been a God-fearing Semite.

Moses' years in Midian were years of humiliation. He gave expression to his feelings by naming his first son Gershom (v. 22), meaning "Banishment" or "A Stranger There."

"The pride and self-will with which he had offered himself in Egypt as the deliverer and judge of his oppressed brethren, had been broken down by the feeling of exile."<sup>2</sup>

"Egypt accomplished him as a scholar, a gentleman, a statesman, a soldier, but yet he lacked one thing, in which the court of Egypt could not befriend him. He must know what it was to live a life of communion with God; and in this he would be greatly furthered by the solitude and retirement of a shepherd's life in Midian."<sup>3</sup>

Moses lived in Midian "many days" (v. 23) before Pharaoh (Thutmose III) died. Stephen said it was a period of 40 years (Acts 7:30).

"... Moses is at home in the author's view because he has come at last to a people who worship the God of his fathers. The Moses-Midian connection is theological. Suggested deftly in this climactic section of the narrative of chap. 2, that connection will be affirmed in chaps. 3—4 and 18."<sup>4</sup>

The prayers ("cry for help," v. 23) of the Israelites in their bondage touched God's heart ("God heard their groaning; and God remembered His covenant

---

<sup>1</sup>Wiersbe, p. 182.

<sup>2</sup>Keil and Delitzsch, 1:435.

<sup>3</sup>Henry, p. 74.

<sup>4</sup>Durham, p. 22.

with Abraham, Isaac, and Jacob," v. 24), and He began anew to act for them ("And God saw the sons of Israel, and God took notice of them," v. 25; cf. 3:7-9). This is another of the many references in Scripture that indicate that prayer affects some of God's actions. Remembering His covenant with the patriarchs, God acted for the Israelites by commissioning Moses.

God graciously and sovereignly used Moses' sin (evidently manslaughter, v. 12) to bring ultimate blessing for His chosen people (cf. Rom. 5:20). This is important to observe as we seek to understand God's ways.

### **6. Moses' call 3:1—4:18**

3:1-12 Horeb (lit. "Desolate Place") is another name for Sinai (v. 1). It probably indicates a range of mountains rather than a particular mountain peak. The writer called it "the mountain of God" because it was the place where God later gave the Mosaic Law to Israel. The traditional site of Mt. Sinai and the Horeb range is in the southern Sinai Peninsula. However, some Scripture references cast this location into question (cf. Deut. 33:2; Gal. 4:25). These references suggest that the site may have been somewhere on the east side of the Gulf of Aqabah.<sup>1</sup>

Here "the angel of the LORD" is clearly God (Yahweh, v. 2; cf. vv. 4, 6, 7). He was not an angelic messenger but God Himself. This becomes clear as the incident unfolds.

A burning thorn-bush was then, and is still today, not uncommon in the Sinai desert.<sup>2</sup> These bushes sometimes burst into flame spontaneously. This bush was unusual, however, because even though it was burning, it did not burn up (v. 3). The monastery of St. Catherine is supposed to be on the exact site of Moses' burning bush, according to ancient tradition.<sup>3</sup>

---

<sup>1</sup>For rebuttal, see Gordon Franz, "Mt. Sinai Is *Not* Jebel El-Lawz in Saudi Arabia," a paper presented at the Annual Meeting of the Evangelical Theological Society, 15 November 2001, Colorado Springs, Colo.

<sup>2</sup>Cassuto, p. 31.

<sup>3</sup>See Philip C. Johnson, "Exodus," in *The Wycliffe Bible Commentary*, p. 54.



Jewish and Christian interpreters have long seen the bush in this incident as a symbol of the nation of Israel, ignoble or common in relation to other nations (cf. Judg. 9:15). Possibly the fire symbolized the affliction of Egyptian bondage (cf. Deut. 4:20). The Israelites were suffering as a result of this hostility, but God did not allow them to be consumed (suffer extinction as a people) from it. Because Israel has frequently been in the furnace of affliction throughout history, though not consumed, Jews have identified the burning bush as a symbol of their race. This symbol often appears on the walls of synagogues or in other prominent places, not only in modern Israel, but also in settlements of Jews around the world. The fire probably also symbolized the presence of God dwelling among His people (cf. Gen. 15:17; Exod. 19:18; 40:38).<sup>1</sup> God was with His people in their affliction (cf. Deut. 31:6; Josh. 1:5; Dan. 3:25; Heb. 13:5). Some interpreters believe that it was also a picture of what God had planned for Moses: "he was the weak bush but God was the empowering fire (19:18; 24:17; Deut. 4:24; Judg. 13:20; Heb. 12:29."<sup>2</sup>

"This episode, then, presages the upheaval of the natural phenomena in the plagues and the crossing of the Red Sea."<sup>3</sup>

This was the first time that God had revealed Himself to Moses, or anyone else as far as Scripture records, for over 430 years (v. 4). When Moses turned aside, God called to him (cf. James 4:8). Later in history, God broke another 400-year long period of prophetic silence, when John the Baptist and Jesus appeared to lead an even more significant exodus. God raised up Jesus, another outcast, to lead His people out of spiritual bondage.

The custom of removing one's shoes, out of respect, is very old (v. 5). It was common in Moses' day in the ancient world,

---

<sup>1</sup>See Milton S. Terry, *Biblical Hermeneutics*, pp. 347-68, on the interpretation of symbols.

<sup>2</sup>Wiersbe, p. 183.

<sup>3</sup>Enns, p. 97.

and is still common today.<sup>1</sup> For example, when one enters a Moslem mosque, he must remove his shoes.

"God begins his discourse with Moses by warning him not to come near to him because he is holy (v. 5). As we will later see, the idea of God's holiness is a central theme in the remainder of the book. Indeed, the whole structure of Israel's worship of God at the tabernacle is based on a view of God as the absolutely Holy One who has come to dwell in their midst. We should not lose sight of the fact, however, that at the same time that God warns Moses to stand at a distance, he also speaks to him 'face to face' (cf. Nu 12:8). The fact that God is a holy God should not be understood to mean that he is an impersonal force—God is holy yet intensely personal. This is a central theme in the narratives of the Sinai covenant that follow."<sup>2</sup>

God proceeded to explain the reason for His revelation (vv. 7-10): The suffering of His people had touched His heart. He had heard their cries and seen their affliction. Now He purposed to deliver them. The compassion of God stands out in these verses.

"The anthropomorphisms (i.e., the descriptions of God's actions and attributes in words usually associated with mankind) in vv. 7-8 of God's 'seeing,' 'hearing,' 'knowing' (= 'be concerned about'), and 'coming down' became graphic ways to describe divine realities for which no description existed except for partially analogous situations in the human realm. But these do not imply that God has corporeal and spatial limitations; rather, he is a living person who can and does follow the stream of human events and

---

<sup>1</sup>Keil and Delitzsch, 1:437-40.

<sup>2</sup>Sailhamer, *The Pentateuch ...*, p. 245. See Peter J. Gentry, "The Meaning of 'Holy' in the Old Testament," *Bibliotheca Sacra* 170:680 (October-December 2013):400-17.

who can and does at times directly intervene in human affairs."<sup>1</sup>

"Is there no discrepancy between these two announcements ["I have come down to rescue," v. 8, and "I will send you," v. 10]? If God has Himself come down to do the work of redemption, what need of Moses? Would not a word from those almighty lips be enough? Why summon a shepherd, a lonely and unbefriended man, a man who has already failed once, and from whom the passing years have stolen his manhood's prime, to work out with painful elaboration, and through a series of bewildering disappointments, the purposed emancipation? But this is not an isolated case. Throughout the entire scheme of Divine government, we meet with the principle of mediation. God ever speaks to men, and works for them, through the instrumentality of men. Chosen agents are called into the inner circle, to catch the Divine thought and mirror the Divine character, and then sent back to their fellows, to cause them to partake."<sup>2</sup>

When people fail to acknowledge what the Scriptures teach about divine election, they limit their appreciation of divine grace (cf. Luke 7:47; John 15:16). God chose even a few murderers to serve Him, so that they would appreciate His grace all the more (e.g., Moses, David, Paul).

The description of Canaan as a land "flowing with milk and honey" (vv. 8, 17) is a common biblical one. It pictures an abundance of grass, fruit trees, and flowers—where cows, goats, and bees thrive—and where the best drink and food abound. The operative word in the description is "flowing." This is a picture of a land in contrast to Egypt, where sedentary farming was common. In Canaan, the Israelites would experience a different form of life, namely, a pastoral lifestyle.

---

<sup>1</sup>Kaiser, "Exodus," p. 316.

<sup>2</sup>Meyer, p. 43.

Canaan depended on rainfall, whereas Egypt did not; it depended on the Nile River.<sup>1</sup>

"This formula was at first coined by the nomadic shepherds to denote a land blessed with pastures for cattle producing milk and with trees whose boughs afforded man, without the necessity for hard toil, food as nourishing and as sweet as bees' honey. In the course of time the signification of the phrase was extended to include also land that yielded rich harvests as a result of human labour."<sup>2</sup>

Some people have argued that the Promised Land was not large enough to sustain over two million Israelites plus Canaanites. Thus the number of Israelites who entered and lived there must have been considerably smaller. Perhaps the solution to this problem is the extraordinary fruitfulness of the land. We may underestimate the extreme agricultural productiveness of the land when we read that it flowed with milk and honey.

Often Moses listed seven distinct, idol-worshipping tribes as possessing Canaan (e.g., Deut. 7:1), but he also named six (v. 8), 10 (Gen. 15:19-21), and 12 (Gen. 10:15-18) tribes, as the resident inhabitants, in various Scripture passages.

"At the death of Pharaoh, Egyptian authorities dropped all pending charges, even in capital cases (see 4:19)."<sup>3</sup>

This was why Moses could now return to Egypt. The Pharaoh to whom Moses referred here (v. 10) was very likely Amenhotep II, who succeeded Thutmose III, and ruled from 1450 to 1425 B.C.<sup>4</sup> He ruled during the very zenith of Egypt's power, prestige, and glory as a world government.

---

<sup>1</sup>Barry J. Beitzel, *The Moody Atlas of Bible Lands*, p. 49.

<sup>2</sup>Cassuto, p. 34.

<sup>3</sup>*The Nelson ...*, p. 102.

<sup>4</sup>See Gleason L. Archer Jr., *A Survey of Old Testament Introduction*, p. 223; Free, p. 90.

"Coming to the throne at the age of 18 in 1450 B.C., he would have been about 22 in 1446 B.C. and in his fourth year of rule."<sup>1</sup>

Moses had become genuinely humble during his years as a mere shepherd in Midian (v. 11; cf. Num. 12:3). Earlier an Israelite had asked Moses, "Who made you a ruler and a judge over us?" (2:14). Now Moses asked the same thing of God: "Who am I, that I should ... bring the sons of Israel out of Egypt?" (v. 11). This is the first of five protests that Moses voiced against accepting God's commission (cf. vv. 11, 13; 4:1, 10, 13).

"Some time before he had offered himself of his own accord as a deliverer and judge; but now he had learned humility in the school of Midian, and was filled in consequence with distrust of his own power and fitness. The son of Pharaoh's daughter had become a shepherd, and felt himself too weak to go to Pharaoh."<sup>2</sup>

Moses was reluctant to serve God because he was too self-conscious, and not God-conscious enough. We need to balance the truth of John 15:5 ("Without me you can do nothing.") with that of Philippians 4:13 ("I can do all things through Christ who strengthens me."). Our success as God's servants does not depend on our natural abilities, as much as on our trust and obedience. As the sign on the church marquee proclaimed: "God doesn't call the qualified. He qualifies the called."

"In these verses [11-12], the presentation of the tetragrammaton is only introduced. Moses objected, ... 'Who am I, ... that I ... that I ... ?' and God answers, ... 'the point is I AM with you.' Who

---

<sup>1</sup>Wood, p. 123, n. 56.

<sup>2</sup>Keil and Delitzsch, 1:440-41. See Frederick Holmgren, "Before the temple, the thornbush: an exposition of Exodus 2:11—3:12," *The Reformed Journal* 33:3 (March 1983):9-11; Robert J. Voss, "Who Am I That I Should Go? Exodus 3:11 (Exod. 2:25—4:18)," *Wisconsin Lutheran Quarterly* 80:4 (Fall 1983):243-47.

Moses is is not the question; it is rather, who is *with* Moses?"<sup>1</sup>

"The truth is, any old bush will do as long as God is in the bush."<sup>2</sup>

"As long as a man holds that he is easily able to do some great deed of heroism and faith, he is probably incompetent for it, but when he protests his inability, and puts away the earliest proposals, though made by the Almighty Himself, he gives the first unmistakable sign that he has been rightly designated."<sup>3</sup>

God gave Moses a sign to inspire his courage and confidence—that God would make his mission a success (v. 12; cf. Gen. 37:5-11). This sign was evidently the burning bush, though other signs would follow. God also gave Moses a promise that he would return with the Israelites to the very mountain where he stood then. This promise required faith on Moses' part, but it was also an encouragement to him. As surely as God had revealed Himself to Moses there once, He promised to bring Moses back to Horeb to worship Him, a second time, with the Israelites.

"... the experience of Moses in 3:1-12 is an exact foreshadowing of the experience of Israel, first in Egypt, then in the deprivation of the wilderness, and finally at Sinai."<sup>4</sup>

God called Moses to be the first in a long line of mediatorial rulers in the nation of Israel. Significantly, God prepared Moses as He prepared David: by first making him a shepherd of sheep.

---

<sup>1</sup>Durham, p. 33.

<sup>2</sup>Swindoll, p. 106.

<sup>3</sup>Meyer, p. 45.

<sup>4</sup>Durham, p. 30.

God called the Israelites "My people" (v. 10), but Moses fulfilled the role of their human leader as their virtual king.<sup>1</sup>

"Moses exercised the office of a king; he represented the invisible King."<sup>2</sup>

"Viewed from the Biblical standpoint, the one *divine* kingdom of Old Testament history began with Moses, not with Saul."<sup>3</sup>

3:13-22 Moses' first objection amounted to "I don't think I can do this" (v. 11). His second objection was, "No one else will think I can do this, either." Moses' fear that the Israelite elders would not accept him is understandable (v. 13). God had not revealed Himself to His people for over 400 years. When Moses asked how he should answer the Israelites' question, "What is His name?", he was asking how he could demonstrate and prove to them that it was *the God of their fathers* who had sent him. Since the Israelites had lived in polytheistic Egypt for over 400 years, and since the Egyptians worshipped hundreds, if not thousands of gods, it seems likely that Moses expected them to ask him which one of *those* gods was he talking about.

"According to the conception prevailing in the ancient East, the designation of an entity was to be equated, as it were, with its existence: whatever is without an appellation [name] does not exist, but whatever has a denomination has existence."<sup>4</sup>

"What Moses asks, then, has to do with whether God can accomplish what he is promising. What is there in his reputation (see Num 6:27; Deut 12:5, 11; 16:2-6; Pss 8:1, 74:7; Amos 5:8, 9:5-6; Jer 33:2) that lends credibility to the claim in his call? How, suddenly, can he be expected to deal with a

---

<sup>1</sup>See Alva J. McClain, *The Greatness of the Kingdom*, pp. 56-60: "Moses—First Mediatorial Ruler of Israel."

<sup>2</sup>Oswald T. Allis, *Prophecy and the Church*, p. 59.

<sup>3</sup>McClain, p. 103.

<sup>4</sup>Cassuto, pp. 36-37.

host of powerful Egyptian deities against whom, across so many years, he has apparently won no victory for his people?"<sup>1</sup>

One suggestion as to the meaning of God's reply, in verse 14, is that God was explaining and elaborating on the name by which He made Himself known to Abraham ("the LORD who brought you out of Ur of the Chaldeans," Gen. 15:7).

"The repetition of the same word [I am] suggests the idea of uninterrupted continuance and boundless duration."<sup>2</sup>

Yet it means more than this.

"To the Hebrew 'to be' does not just mean to exist as all other beings and things do as well—but to be active, to express oneself in active being, 'The God who acts.' 'I am what in creative activity and everywhere I turn out to be,' or 'I am (the God) that really acts.'"<sup>3</sup>

"I am that I am" means "God will reveal Himself in His actions through history."<sup>4</sup>

Other translations are, "I will be what I will be," "I am the existing One," and "I cause to be what comes to pass."<sup>5</sup> One writer paraphrased God's answer, "It is I who am with you."<sup>6</sup> Another, "What does it matter who I am?"<sup>7</sup> In other words, the One who had promised to be with the descendants of Abraham, Isaac, and Jacob had sent Moses to them. The

---

<sup>1</sup>Durham, p. 38.

<sup>2</sup>Keil and Delitzsch, 1:442-43.

<sup>3</sup>Sigmund Mowinckel, "The Name of the God of Moses," *Hebrew Union College Annual* 32 (1961):127.

<sup>4</sup>Charles Gianotti, "The Meaning of the Divine Name YHWH," *Bibliotheca Sacra* 142:565 (January-March 1985):45.

<sup>5</sup>Johnson, pp. 54-55.

<sup>6</sup>Cassuto, p. 38.

<sup>7</sup>Cornelis Houtman, *Exodus*, 1:367.



Hebrew word translated I AM is similar to the Hebrew name Yahweh.

"The answer Moses receives [in verse 14] is not, by any stretch of the imagination, a name. It is an assertion of authority, a confession of an essential reality, and thus an entirely appropriate response to the question Moses poses."<sup>1</sup>

Moses had asked, "Who am I?"—implying complete inadequacy for his calling. God replied, "I AM WHO I AM!"—implying His complete adequacy. The issue was not who Moses was, but who God is. I believe God was saying, "I am the God of your forefathers, who proved Myself long ago as completely adequate for all their needs; so it really doesn't matter who you are, Moses!" Moses would learn the complete adequacy of God Himself in the events that followed. Later, Pharaoh would say, "Who is the LORD?" (5:2). God's response was, "I am the LORD!" (6:2, 6, 7). Pharaoh, too, then learned God's complete adequacy. The real issue, then, was, and still is, who God is. Consequently, it is extremely important that we have a correct understanding of the Person of God.

"What comes into our minds when we think about God is the most important thing about us."<sup>2</sup>

There is an interesting interchange involving identity in this conversation. Moses said, "Who am I?" implying that he was nobody. He said the Israelites would ask, "Who is He?" implying that the One who had sent Moses to them was unknown to them. The LORD replied, "I AM WHO I AM," clarifying that He was the God who had been, and who always would be—the same God that their forefathers worshipped (v. 6). In effect, God was saying, "It's Me!" The Israelites and Moses had heard about their God, but He had not revealed Himself to them for over 400 years. Now He had reappeared, and would

---

<sup>1</sup>Durham, p. 38.

<sup>2</sup>A. W. Tozer, *The Knowledge of the Holy*, p. 9.

demonstrate to them who He was—in the plagues and the Exodus to come!

"... I AM WHO I AM' can be understood ... as a near refusal to dignify Moses' question with an answer: 'I AM WHO I AM, they know very well who I am. What a question!'"<sup>1</sup>

"I AM" became a new name for God here. In verse 15, God gave them His older name by which they had known Him: "The LORD, the God of your fathers, the God of Abraham, the God of Isaac, and the God of Jacob ... This is My name forever, and this is the name for all generations to use to call upon Me."

Verse 16 is also the first reference to "the elders of Israel."<sup>2</sup> The elders were the leaders of the various groups of Israelites.

God told Moses to request Pharaoh's permission for the Israelites to leave Egypt (v. 18).

"The sequel shows that there was no element of deceit in the request for 'a three days' journey into the wilderness,' i.e., right out of contact with the Egyptian frontier guards. Pharaoh knew perfectly well that this implied no return; indeed, since Israel was a tolerated alien people, he would have no claim on their return, once they had left his territory."<sup>3</sup>

"Moses' demand for complete freedom, though couched in polite words, is there from the start."<sup>4</sup>

Another possibility, which I prefer, is that the request to leave Egypt for only three days was sincere. At first, God gave Pharaoh this option. However, God knew, and He told Moses, that Pharaoh would not grant this request. So, after Pharaoh

---

<sup>1</sup>Enns, p. 103.

<sup>2</sup>See Leslie Hoppe, "Elders and Deuteronomy," *Eglise et Theologie* 14 (1983):259-72.

<sup>3</sup>H. L. Ellison, *Exodus*, p. 22.

<sup>4</sup>R. Alan Cole, *Exodus*, p. 72.

refused, God told Moses to "up the stakes" and request a complete and final liberation of the Israelites.

The miraculous signs God proceeded to give Moses would demonstrate to the Israelites that their God was again actively working for them (v. 20; cf. 4:2-9). God reassured Moses that the Israelites would believe him (v. 18).

Probably there were several reasons the Israelites were to ask their Egyptian neighbors for jewelry ("articles of silver and articles of gold") and "clothing" (v. 22). By doing so, they would humiliate the Egyptians further. That is, they would demonstrate in this way the superiority of their God over the gods of Egypt. They would also obtain materials and tools needed for the wilderness march and the construction of the tabernacle. Moreover, they would receive partial payment for the labor the Egyptians had stolen from them during their years of slavery (cf. Deut. 15:12-15).

The writer stated God's sovereignty over Pharaoh in verses 14-22. God demonstrated it in the plagues that followed (chs. 5—11).<sup>1</sup>

"With the name 'Yahweh' revealed and explained and with the proof of this explanation illustrated, at least in prospect, Moses can have no further question about *God's* authority. The narrative deals next with Moses' own authority, and how that is to be made clear."<sup>2</sup>

4:1-9

"He [Moses] was so worried about what *might* happen, he didn't hear God tell him what *would* happen. His mind was filled with imaginary scenarios."<sup>3</sup>

God gave Moses the ability to perform three miracles, in order to convince the Israelites that the God of their fathers had appeared to him. They also served to bolster Moses' faith.

---

<sup>1</sup>See *ibid.*, pp. 19-40, for an exposition of the character of God as revealed in Exodus.

<sup>2</sup>Durham, p. 41.

<sup>3</sup>Swindoll, p. 119.

Moses had left Egypt and the Israelites with a clouded reputation, under the sentence of death, and he had been away for a long time. He needed to prove to his brethren that they could trust and believe him. Not only were these miracles strong proofs of God's power, but they appear to have had special significance for the Israelites as well (cf. v. 8).<sup>1</sup>

God probably intended the first miracle, of the staff and serpent (vv. 2-5), to assure Moses and the Israelites that He was placing the satanic power of Egypt under God's and Moses' authoritative control. This was the power before which Moses had previously fled. Moses' humble shepherd staff now became a symbol of authority in his hand, a virtual scepter.

"Pharaoh had turned the rod of government into the serpent of oppression, from which Moses had himself fled into Midian; but by the agency of Moses the scene was altered again."<sup>2</sup>

The serpent represented the deadly, satanic power of Egypt, that sought to kill the Israelites, and Moses in particular. The Pharaohs wore a religiously symbolic metal cobra around their heads. It was a common symbol of Egyptian royal authority.<sup>3</sup> However, the serpent also stood for the great enemy of man behind that power—Satan—who had been the foe of the seed of the woman since the Fall (Gen. 3:15). Moses' ability to turn the serpent into his staff—by seizing its tail—would have encouraged the Israelites. With these miraculous proofs, they ought to have believed that God had enabled Moses to overcome the cunning and might of Egypt, and to exercise authority over its fearsome power. This was a sign that God would bless Moses' leadership.

The second miracle, of the leprous hand (vv. 6-7), evidently assured Moses that God would bring him and the Israelites out of their defiling environment—and heal them. But first, He would punish the Egyptians with crippling afflictions: the

---

<sup>1</sup>Johnson, p. 55.

<sup>2</sup>Henry, p. 76.

<sup>3</sup>Enns, p. 109.

plagues. Presently the Israelites were unclean because of their confinement in wicked Egypt. Moses' hand was the instrument of his strength. As such, it was a good symbol of Moses, himself being the instrument of God's strength in delivering the Israelites, and Israel, God's instrument for blessing the world.<sup>1</sup> Moses' leprous hand miracle would also have suggested to Pharaoh that Yahweh could afflict or deliver through His representative at will. The miraculous restoration to health of Moses' hand may have also attested to God's delegation of divine power to him.

The third miracle, of the water turned into blood (v. 9), provided assurance that God would humiliate the Egyptians by spoiling what they regarded as a divine source of life. The Egyptians identified the Nile River with the Egyptian god Osiris, and credited it with all good and prosperity in their national life. Blood was and is a symbol of life poured out in death (cf. Lev. 17:11). Moses possessed the power to change the life-giving water of the Nile into blood. (Josephus wrote that the color of the water was that of blood, "but it brought upon those that ventured to drink of it, great pains and bitter torment."<sup>2</sup>) The Israelites would have concluded from this sign that Moses also had the power to destroy the gods of Egypt, and to punish the land with death (cf. 7:14-24).

"Like Abel's blood that cried out from the ground, so would the infants' whose lives had been demanded by Pharaoh (1:22)."<sup>3</sup>

Each of these signs attested to Yahweh's creative power. Normally at least two witnesses were necessary to establish credibility under the Mosaic Law (Deut. 19:15). A third witness further strengthened the truthfulness of the testimony. Here, God gave Moses three "witnesses" to confirm His prophet's divine calling and enablement. God entrusted Moses with His

---

<sup>1</sup>For an explanation of the Septuagint's omission of "leprous" from verse 6, see Cornelis Houtman, "A Note on the LXX Version of Exodus 4, 6," *Zeitschrift für die Alttestamentliche Wissenschaft* 97:2 (1983):253-54.

<sup>2</sup>Josephus, *Antiquities of ...*, 2:12:3; 2:14:1.

<sup>3</sup>Kaiser, "Exodus," p. 326.

powerful word and endowed him with His mighty power. Moses was the first prophet with the power to perform miracles, as far as Scripture records.

4:10-17 Rather than inspiring confidence in Moses, God's commission frightened him (vv. 10-12). Moses' claim to be "slow of speech and slow of tongue" (not handicapped, but lacking in eloquence) was a thinly veiled excuse, by which Moses hoped to escape his calling. Stephen said Moses was "proficient in speaking" (Acts 7:22). Apparently Moses felt that he did not have sufficient oratorical ability to persuade the Israelite elders or Pharaoh ("I have never been eloquent," v. 10). So Moses' limitation was psychological, not physical.<sup>1</sup> God assured Moses that He would enable Him to communicate effectively. Again, God reminded Moses that He was the Creator (v. 11; cf. 3:16).

"This claim of inadequacy is a recurring one in OT passages having to do with God's call and commission (cf., e.g., Judg 6:14-15; 1 Sam 10:20-24; 1 Kgs 3:5-9; Isa 6:5-8; Jer 1:4-10; see also Habel ...<sup>2</sup> Whatever its connection to prophetic and royal traditions of the word and the messenger, its more important rootage is in the OT pattern of the weak become strong, the least become great, the mean become mighty, the last become first (cf., e.g., Judg 6:11-24; 1 Sam 16:1-13; 17:19-54; Amos 7:14-15; Isa 6:1-13; Jer 1:4-19; and even Isa 52:13-53:12). This pattern is a metaphor of theological assertion in the Bible, and everywhere it occurs, its fundamental message is the same: God's word, God's rule, God's teaching, God's deliverance come not from man, no matter who that man may be, but from God. Even the election of Israel makes this point. Indeed that

---

<sup>1</sup>McGee, 1:222.

<sup>2</sup>N. Habel, "The Form and Significance of the Call Narratives," *Zeitschrift für die Alttestamentliche Wissenschaft* 77 (1965):316-23.

election is probably the most convincing of all the occurrences of the pattern."<sup>1</sup>

"Cherish the lowliest thought you choose of yourself, but unite it with the loftiest conception of God's All-Sufficiency. Self-depreciation may lead to the marring of a useful life. We must think soberly of ourselves, not too lowly, as not too extravagantly. The one talent must not be buried in the earth."<sup>2</sup>

Charles Swindoll restated Moses' four objections to God's call as follows: "I don't have all the answers" (3:13), "I may not have their [the Israelites'] respect" (4:1), "I'm slow in my expressions" (4:10), and "I'm not as qualified as others" (4:13).<sup>3</sup>

Unable to excuse himself, Moses finally admitted that he did not want to obey God ("send the message by whomever [else] You will," vv. 13-16). God became angry with Moses because he refused to obey. However, the sovereign LORD would not let His reluctant servant go (cf. Jonah). Instead, He provided a mouthpiece for Moses—a press secretary, a human loudspeaker—in his older brother by three years, Aaron (v. 16). This act was both an aid to Moses and a discipline for his disobedience. On the one hand, Aaron was an encouragement to Moses, but on the other, he proved to be a source of frustration as a mediator (cf. ch. 32).

"The prophet had one job: to represent accurately the message of the one who sent him or her. Moses would be as God to Aaron because he would tell him what to say, just as God would tell Moses what to say."<sup>4</sup>

---

<sup>1</sup>Durham, p. 49.

<sup>2</sup>Meyer, p. 71.

<sup>3</sup>Swindoll, pp. 116, 118, 121, 124. See also idem, *Three Steps Forward, Two Steps Back*, ch. 9: "Inferiority: Contagious Plague of Self-Doubt," pp. 117-35.

<sup>4</sup>*The Nelson ...*, p. 105.

"The mouth of Moses may well be heavy and clumsy, slow and halting in speech. It would not matter if it were dumb altogether, and Aaron's mouth, as well. Yahweh will be there, and Yahweh will take responsibility for both the message and the messengers. The staff in the hands of Moses and Aaron is a symbol of this powerful Presence."<sup>1</sup>

Apparently Aaron was to speak for Moses only "to the people" of Israel (v. 16; cf. v. 30), not to Pharaoh. It was only later that God told Moses to speak to Pharaoh (v. 22). This explains the fact that when Moses stood before Pharaoh it was he, not Aaron, who did the speaking.

As time passed, Moses grew more confident and communicative, and increasingly took his proper place as Israel's leader.

"Christ sent his disciples two and two, and some of the couples were brothers."<sup>2</sup>

4:18 Moses' pessimism concerning the welfare of the Israelites comes out in his request that Jethro (the Reuel of 2:18; cf. 3:1) let him return to Egypt. Was Moses lying to Jethro? After all, God had told him to return to Egypt, not to see how the Israelites were faring, but to lead them out of Egypt. I believe what Moses told Jethro was one motive in Moses' mind, and so what he said was not a lie. He just did not mention his divine commission. Perhaps Moses concluded that, if he told Jethro about his commission, his father-in-law would have opposed his return more strongly.

This section makes it possible for us to gain great insight into Moses' feelings about God's promises to his forefathers, and about his own life. Moses had become thoroughly disillusioned. He regarded himself as a failure, the objects of his ministry as hopeless, and God as unfaithful, uncaring, and unable to deliver His people. He had learned his own inability to deliver Israel, but he did not yet believe in God's ability to do so. Even

---

<sup>1</sup>Durham, p. 51.

<sup>2</sup>Henry, p. 76.



the miraculous revelation of God at the burning bush, and the miracles that God enabled Moses to perform, did not convince him of God's purpose and power.

One supernatural revelation, even one involving miracles, does not usually change convictions that a person has built up over years of experience. We not only need to believe in our own inability to produce supernatural change, as Moses did, but we also need to believe in God's ability to produce it. Moses had not yet learned the second lesson, which God proceeded to teach him.

### 7. Moses' return to Egypt 4:19-31

4:19-23 God spoke to Moses again, this time when he was back in Midian from Horeb, and sent him back to Egypt. He assured His servant that everyone who was seeking his life earlier was dead. Evidently Moses had been stalling. Compare Abram's stalling in Haran, until God again urged him to press on to the unknown Promised Land (Gen. 11:31—12:4). Another possibility is that we should translate "the LORD said" (v. 19, NASB, AV, NKJV, ESV, NRSV, NEB) as "the LORD *had* said" (NIV, TNIV, cf. CEV). This is a legitimate translation, since the Hebrew language has no pluperfect tense. In this case, verse 19 precedes verse 18 chronologically.

Verse 19 may sound like God had to wait until all the people who were seeking to kill Moses had died before He could send Moses back to Egypt. This is hardly in harmony with the revelation of God's sovereign control over all events that runs throughout Exodus. Perhaps God's statement was an announcement to Moses that the first installment of the Exodus had commenced.<sup>1</sup> In other words, God's timing was an encouragement to Moses, rather than an indication of God's limited sovereignty.

Verse 20 describes what Moses did after God's full revelation to him, in Midian, that continues in verses 21-23. We learn here for the first time that Moses had sons (plural; cf. 2:22; 18:4).

---

<sup>1</sup>Enns, pp. 128-29.

"The likely reason why only Gershom's name was mentioned in chapter 2 is because the etymology of his name served the writer's theological purpose in that context. He wished to highlight Moses' sojourning in a foreign land (see 2:22)."<sup>1</sup>

Later we will read that Jethro brought Moses' wife and two sons from Midian to Moses in the wilderness (18:2-7). Evidently Moses had sent his family back to Midian sometime after they arrived in Egypt.

In verses 21-23, God gave Moses a preview of all that would take place in his dealings with Pharaoh. This is the first mention in Exodus that Moses was to perform signs *before Pharaoh*. When God said that He would "harden his [Pharaoh's] heart" (v. 21), He was not saying that Pharaoh would be unable to choose whether he would release the Israelites. God made Pharaoh's heart progressively harder as the king repeatedly chose to disobey God's will (cf. Lev. 26:23-24).

"The *hardening of Pharaoh* is ascribed to God, not only in the passages just quoted [14:4, 17; 7:3; and 10:1], but also in 9:12; 10:20, 27; 11:10; 14:8; that is to say, ten times in all; and that not merely as foreknown by Jehovah, but as caused and effected by Him. In the last five passages it is invariably stated that 'Jehovah hardened ... Pharaoh's heart.' But it is also stated just as often, viz. ten times, that Pharaoh hardened his own heart, or made it heavy or firm; e.g., in 7:13, 22; 8:15; 9:35; ... 7:14; ... 9:7; ... 8:11, 28; 9:34; ... 13:15. ...

"According to this, the hardening of Pharaoh was quite as much his own act as the decree of God. But if, in order to determine the precise relation of the divine to the human causality, we look more carefully at the two classes of expressions, we shall find that not only in connection with the first

---

<sup>1</sup>Ibid., p. 129.

sign, by which Moses and Aaron were to show their credentials as the messengers of Jehovah, sent with the demand that he would let the people of Israel go (7:13-14), but after the first five penal miracles, the hardening is invariably represented as his own. ... It is not till after the sixth plague that it is stated that Jehovah made the heart of Pharaoh firm (9:12). ... Looked at from this side, the hardening was a fruit of sin, a consequence of self-will, high-mindedness, and pride which flowed from sin, and a continuous and ever increasing abuse of that freedom of the will which is innate in man, and which involves the possibility of obstinate resistance to the word and chastisement of God even until death. ...

"... God not only permits a man to harden himself; He also produced obduracy, and suspends this sentence over the impenitent. Not as though God took pleasure in the death of the wicked! No; God desires that the wicked should repent of his evil way and live (Ezek. 33:11); and He desires this most earnestly, for 'He will have all men to be saved and to come unto the knowledge of the truth' (1 Tim. 2:4; cf. 2 Pet. 3:9). As God causes His earthly sun to rise upon the evil and the good, and sendeth rain on the just and the unjust (Matt. 5:45), so He causes His sun of grace to shine upon all sinners, to lead them to life and salvation.

"The sun, by the force of its heat, moistens the wax and dries the clay, softening the one and hardening the other; and as this produces opposite effects by the same power, so, through the long-suffering of God, which reaches to all, some receive good and others evil, some are softened and others hardened' (Theodoret).

"It is the curse of sin, that it renders the hard heart harder, and less susceptible to the gracious

manifestations of divine love, long-suffering, and patience. In this twofold manner God produces hardness, not only *permissive* but *effective*; i.e., not only by giving time and space for the manifestation of human opposition, even to the utmost limits of creaturely freedom, but still more by those continued manifestations of His will which drive the hard heart to such utter obduracy that it is no longer capable of returning, and so giving over the hardened sinner to the judgment of damnation. This is what we find in the case of Pharaoh."<sup>1</sup>

See Romans 1:24-32 for the New Testament expression of this truth.

Even though God's hardening of Pharaoh's heart was only the complement of Pharaoh's hardening his own heart, God revealed only the former action in verse 21. God's purpose in this revelation was to prepare Moses for the opposition he would face. He also intended to strengthen Moses's faith, by preventing any questions that might arise in his mind—concerning God's omniscience—as his conflict with Pharaoh intensified.<sup>2</sup>

"Egyptians believed that when a person died his heart was weighed in the hall of judgment. If one's heart was 'heavy' with sin, that person was judged. A stone beetle scarab was placed on the heart of the deceased person to suppress his natural tendency to confess sin which would subject himself to judgment. This 'hardening of

---

<sup>1</sup>Keil and Delitzsch, 1:453-456. See also Johnson, p. 56; Walter C. Kaiser Jr., *Toward Old Testament Ethics*, p. 255; Nahum M. Sarna, *Exodus*, p. 23; Robert B. Chisholm, "Divine Hardening in the Old Testament," *Bibliotheca Sacra* 153:612 (October-December 1996):411, 429; Dorian G. Coover Cox, "The Hardening of Pharaoh's Heart in Its Literary and Cultural Contexts," *Bibliotheca Sacra* 163:651 (July-September 2006):292-311.

<sup>2</sup>F. E. Deist, "Who is to blame: the Pharaoh, Yahweh or circumstance? On human responsibility, and divine ordinance in Exodus 1—14," *OTWSA* 29(1986):91-110, argued that documents J, D, and P each give a different answer to the question of the relationship between divine sovereignty and human responsibility.

the heart' by the scarab would result in salvation for the deceased.

"However, God reversed this process in Pharaoh's case. Instead of his heart being suppressed so that he was silent about his sin and thus delivered, his heart became hardened, he confessed his sin (Ex. 9:27, 34; 10:16-17), and his sinfully heavy heart resulted in judgment. For the Egyptians 'hardening of the heart' resulted in silence (absence of confession of sin) and therefore salvation. But God's hardening of Pharaoh's heart resulted in acknowledgment of sin and in judgment."<sup>1</sup>

The real question that God's dealings with Pharaoh raises is: Does man have a free will? Man has limited freedom, not absolute freedom. We have many examples of this fact in analogous relationships: A child has limited freedom under his or her parent. An adult has limited freedom under his or her human government. Likewise, individuals have limited freedom under divine government. God is sovereign, but we are responsible for the decisions God allows us to make (cf. John 1:12; 3:16, 36; 5:24; 6:47; 20:31; Rom. 9:14-21; Jer. 18:1-6).<sup>2</sup>

"Childs suggests that the matter of causality in the heart-hardening is a side-track; that those critics, for example, who have seen here a theological dimension of predestination and freewill, have been wrong. I would say, No, they have been right (at least in principle) to sense such a dimension, but wrong to see the question of divine determination in human affairs arising *only* in connection with Pharaoh's heart-hardening. For the *whole* story may be seen in these terms—Moses and the people, as well as Pharaoh, exist and act within a framework of

---

<sup>1</sup>Hannah, pp. 114-15.

<sup>2</sup>See C. S. Lewis, *Mere Christianity*, pp. 52-53.

divine 'causality.' With them, too, the question arises, Are they independent agents? Are they manipulated by God? (Have they freewill? Are they 'pre-destined?') The story is about freedom; but freedom turns out to involve varieties of servitude.

"Thus Isbell's observation bears repeating: the story is above all one about masters, especially God. No one in the story entirely escapes God's control or its repercussions, whether directly or indirectly. Moses who sits removed in Midian finds himself forced by Yahweh into a direct servitude but is nevertheless allowed to develop a measure of freedom. Pharaoh (Egypt) exalts his own mastery and is cast into a total and mortal servitude. The people of Egypt and Israel are buffeted this way and that in varying indirect roles of servitude. ...

"God himself is depicted as risking insecurity, because that is the price of allowing his servants a dimension of freedom. An exodus story that saw no murmuring, no rebellion (or potential for rebellion) by Moses and by Israel, would indeed be a fairy tale, a piece of soft romance. But to talk of God and 'insecurity' in the same breath is also to see that the gift of human 'freedom' (to some if not to others) itself creates external pressures on God which in turn circumscribe his own action. Egypt/Pharaoh must be made an example of, spectacularly, so that Israel, the whole world, may *freely* come to recognize that Yahweh is indeed master, one who remembers his obligations as well as one who demands 'service' (labour!). In short, in his relations with humankind, God's freedom is

circumscribed by humankind just as the freedom of humankind is circumscribed by God."<sup>1</sup>

Verses 22-23 summarize Moses' future messages to Pharaoh on several different occasions.

Israel was God's firstborn son (v. 22), in the sense that "he" was the nation, among all others, on which God had chosen to place His special blessing. Israel was first in rank and preeminence, by virtue of God's sovereign choice to bless Abraham's seed.

"Since Israel is God's firstborn son, the appropriate punishment against Egypt for harming Israel is for God to harm Egypt's firstborn son."<sup>2</sup>

The essence of the conflict between Pharaoh and Yahweh was the issue of sovereignty. Sovereignty refers to supreme power and authority. Regarding God, it refers to the fact that He has supreme power and authority, more than any other entity. Sovereignty does not specify how one exercises supreme power and authority. Specifically, it does not mean that God exercises His sovereignty by directly controlling everything that happens. Scripture reveals that this is not how He exercises His sovereignty. Rather, He allows people some freedom, yet maintains supreme power and authority.

Were Egypt's gods, or Israel's God, sovereign? That is the question stands out clearly in the following verses that describe the plagues.

"The Egyptian state was not a man-made alternative to other forms of political organization [from the Egyptian point of view]. It was god-

---

<sup>1</sup>David Gunn, "The 'Hardening of Pharaoh's Heart': Plot, Character and Theology in Exodus 1-14," *Art and Meaning: Rhetoric in Biblical Literature*, pp. 88-89. For a more strongly Calvinistic explanation of the hardening of Pharaoh's heart, see G. K. Beale, "An Exegetical and Theological Consideration of the Hardening of Pharaoh's heart in Exodus 4-14 and Romans 9," *Trinity Journal* 5NS:2 (Autumn 1984):129-54. For a helpful discussion of several ways of explaining God's freedom and our freedom, see Axel D. Steuer, "The Freedom of God and Human Freedom," *Scottish Journal of Theology* 36:2:163-180.

<sup>2</sup>Enns, p. 132.

given, established when the world was created; and it continued to form part of the universal order. In the person of Pharaoh a superhuman being had taken charge of the affairs of man. ... The monarch then was as old as the world, for the creator himself had assumed kingly office on the day of creation. Pharaoh was his descendant and his successor."<sup>1</sup>

Pharaoh would not release Yahweh's metaphorical "son," Israel ("you [Pharaoh] have refused to let him go," v. 23). Therefore, Yahweh would "kill" Pharaoh's metaphorical son, namely, the Egyptians as a people, and even his physical son, thus proving His sovereignty.

4:24-26 The events recorded in these verses raise several questions.

Evidently God afflicted Moses ("sought to put him to death"; perhaps making him very ill) because he had not been obedient to Him. Moses had failed to circumcise at least one of his two sons (18:3-4).<sup>2</sup>

"Most likely, Moses had kept one of his sons uncircumcised in order to please his Midianite family. (The Midianites practiced circumcision on a groom right before his marriage instead of circumcising male infants.) ... Many of Israel's neighboring peoples practiced circumcision, but none except Israel circumcised infants."<sup>3</sup>

The Egyptians practiced partial circumcision on adults.<sup>4</sup> God's sentence for this sin of omission (an Israelite failing to have his son circumcised) was death ("cut off from his people," cf. Gen. 17:14). God was ready to carry out this sentence on Moses for his failure (cf. 1 John 5:16). In doing this, God was making Moses face his own incomplete obedience, which reflected his

---

<sup>1</sup>Henri Frankfort, *Ancient Egyptian Religion*, p. 30.

<sup>2</sup>See Gleason L. Archer, *Encyclopedia of Bible Difficulties*, p. 111.

<sup>3</sup>*The Nelson ...*, p. 106.

<sup>4</sup>J. M. Sasson, "Circumcision in the Ancient Near East," *Journal of Biblical Literature* 85 (1966):473-74.



lack of faith in God. God afflicted Moses, but whether He did so naturally or supernaturally is unclear and unimportant. In this incident, God was bringing Moses to the (spiritual) place He brought Jacob to, when He wrestled with him at the Jabbok (Gen. 32). He was getting him to acknowledge His sovereignty over Moses personally.<sup>1</sup>

Zipporah performed the operation at her husband's insistence. It is obvious that she did not approve of it. Most scholars believe that Zipporah cut off her son's foreskin and threw it at Moses' feet, as verse 25 says. One writer believed that she touched Moses' genitals with her son's foreskin.<sup>2</sup> She probably did not, since this was not a puberty rite.<sup>3</sup> Another argued that she threw it at the feet of the pre-incarnate Christ.<sup>4</sup> Perhaps because of Zipporah's resistance to do the will of God, Moses sent her and his sons back to her father at this time. Or the circumcision may have left the boy in such pain that he could not continue the trip to Egypt.<sup>5</sup> Moses may have sent her back during or before the plagues, when his life might have been in danger from the Egyptians. We have no record of exactly when Moses sent his wife and sons back to Midian, but we read of them rejoining Moses later at Sinai (18:2).

The "groom of blood" figure (v. 26) evidently means the following: Apparently Zipporah regarded her act of circumcising her son as the factor that removed God's hand of judgment from Moses, and restored him to life and to her again. It was as though God had given Moses a second chance, and he had begun life as her husband all over again—as a bridegroom (cf. Jonah).<sup>6</sup> She had accepted Yahweh's authority and demands, and was now viewing Moses in the light of God's commission. She therefore abandoned her claim on Moses, and made him available (dedicated or consecrated him) to

---

<sup>1</sup>See M. J. Oosthuizen, "Some thoughts on the interpretation of Exodus 4:24-26," *OTWSA* 29(1986):22-28.

<sup>2</sup>Durham, p. 58.

<sup>3</sup>Kaiser, "Exodus," revised ed., p. 384.

<sup>4</sup>Ronald B. Allen, "The 'Bloody Bridegroom' in Exodus 4:24-26," *Bibliotheca Sacra* 153:611 (July-September 1996):259-69.

<sup>5</sup>Swindoll, *Moses ...*, p. 142.

<sup>6</sup>Cassuto, pp. 59-61.

Yahweh's service.<sup>1</sup> "You are indeed a groom of blood to me!" may have been an ancient marital relationship formula recalling circumcision as a premarital rite.<sup>2</sup>

"Moses has been chosen and commissioned by God, but he has shown himself far from enthusiastic about confronting the Pharaoh and threatening him with the death of his son. YHWH sets about showing Moses that although he is safe from other men (Ex. iv 19) he faces a much greater danger to his life in the wrath of the God whom he is so reluctant to serve (iv 14). Like Jacob before him, Moses must undergo a night struggle with his mysterious God before he can become a worthy instrument of YHWH and can enjoy a completely satisfactory relationship with his brother. In all this, Moses, like Jacob, is not only an historical person, but also a paradigm. The Israelite people, the people whom YHWH has encountered and whom he will slay with pestilence and sword if they go not out into the wilderness to serve him (v. 3), must ponder this story with fear and trembling.

"If Israel is to survive the wrath of YHWH, it must, our text implies, be by virtue of the spilling of atoning blood ... Gershom's blood saves Moses, just as the blood of the Passover lamb will save the Israelites. Since for the sin of the Pharaoh his son's blood will be shed, it is appropriate that the blood which saves Moses should not be his own, but that of his son. It is also fitting that this blood should be blood shed during the rite of circumcision. Since before the Passover lamb is eaten the participants must all be circumcised, it is right that the neglect of Gershom's circumcision (though this omission is not the cause of the

---

<sup>1</sup>Oosthuizen, p. 26.

<sup>2</sup>T. C. Mitchell, "The Meaning of the Noun HTN in the Old Testament," *Vetus Testamentum* 19 (1969):94-105, 111-12.

attack) should be repaired. The boy cannot be circumcised by his father, who is otherwise engaged, so Zipporah takes it upon herself, acting on behalf of her absent father, Jethro (hence the words to Moses 'You are my son-in-law by virtue of blood, the blood of circumcision'), to perform the rite, thus showing herself to be a worthy member of the elite class typified by Rahab the Canaanite harlot and Ruth the Moabitess—the foreign woman who puts Israelites to shame and earns the right to be held up as a model for imitation. Why does she touch Moses' *raglayim* ["feet"] with the severed foreskin? Although, as I have argued, Moses is to be thought of as already circumcised, this action of his wife is, I have suggested, to be construed as a symbolic act of re-circumcision: Moses as representative of the people as a whole is thus symbolically prepared for the imminent Passover celebration. The vocation of the Israelite is a matter of high moment. One's reluctance to serve YHWH wholeheartedly has to be broken down in a fearsome lone struggle in the darkness, and even then before one can meet YHWH there must be a twofold shedding of blood, the blood of circumcision and that of the Passover lamb. Furthermore, the pride of the male Israelite in his high vocation must needs be qualified, by reflecting that in his mysterious strategies for the world YHWH often employs in major roles those who are neither male nor even Israelite."<sup>1</sup>

These few verses underscore a very important principle: Normally, before God will use a person publicly, he or she must first be obedient to God at home (cf. 1 Tim. 3:4-5).

---

<sup>1</sup>Bernard P. Robinson, "Zipporah to the Rescue: A Contextual Study of Exodus IV 24-6," *Vetus Testamentum* 36:4 (October 1986):459-61.

"This story of Moses shows that God would rather have us die than take up His work with unconsecrated hearts and unsundered wills."<sup>1</sup>

Verses 18-23 anticipate the consequences of *Egypt's* not obeying God, and verses 24-26 anticipate the consequences of *Israel's* not obeying God.

4:27-31 Aaron was apparently in Egypt when God told him to "Go to meet Moses in the wilderness," and subsequently directed him to Horeb (v. 27). Moses was apparently on his way from Midian back to Egypt when Aaron met him. Compare the reunion of Jacob and Esau (Gen. 33). Note that it was Aaron, not Moses, who spoke to the Israelites (cf. vv. 14-16). Evidently Moses performed the signs for them (cf. v. 17).

The Israelites believed what Aaron told them, and what Moses' miracles confirmed. They believed that the God of their fathers had appeared to Moses, and had sent him to lead them out of Egypt and into the Promised Land (v. 31; cf. 3:6—4:9).

The relationship of faith and worship is clear in verse 31: "the people believed ... they bowed low and worshiped." Worship is an expression of faith.

## **B. GOD'S DEMONSTRATIONS OF HIS SOVEREIGNTY CHS. 5—11**

God permitted the conflict between Moses and Pharaoh for five reasons at least:

1. In this conflict, God displayed His superior power and sovereignty over Pharaoh and the gods of Egypt.
2. God strengthened the faith of His people, so that they would trust and obey Him, and thereby realize all of His gracious purposes for them as a nation.
3. God also used these events to heighten anticipation of, and appreciation for, the redemption He would provide. The Israelites

---

<sup>1</sup>Meyer, p. 81.

would forever after look back on the Exodus as the greatest demonstration of God's love at work for them.

4. These conflicts show how divine sovereignty works with human freedom. God exercises His sovereignty by allowing people a measure of freedom to make choices, for which he holds them responsible.
5. They also clarify how God hands people over to the consequences of the sins they insist on pursuing—as punishment for their sins.

"It is impossible to find a more exact illustration of the truth of Rom. i. than that presented in this story of Pharaoh's conflict with Jehovah."<sup>1</sup>

### 1. Pharaoh's response to Moses and Aaron's initial request 5:1—6:1

5:1-9 At Moses and Aaron's first audience with Pharaoh, they simply presented God's command ("Let My people go ...," v. 1). They did not perform miracles yet, but only asked for permission to leave Egypt temporarily.

"The Voice of God is the most powerful force in nature, indeed the only force in nature, for all energy is here only because the power-filled Word is being spoken."<sup>2</sup>

By Egyptian law, the Israelites could have worshipped only the gods of Egypt while in the land, but they had to leave Egypt to worship a non-Egyptian God. Moses' request was a request to exercise a basic human right, namely, freedom of worship. Verse 1 does not contradict 3:18: "... say to him [Pharaoh], "... please let us go a three days' journey into the wilderness, so that we may sacrifice to the LORD our God." Celebrating a "feast" (v. 1) would have involved sacrifices.

"Exodus 5:1-5 introduces another aspect of labour in Egypt: claims for time off work, and

---

<sup>1</sup>Ibid., p. 90.

<sup>2</sup>A. W. Tozer, *The Pursuit of God*, p. 74.

specifically for worship or religious holidays. On this topic, useful background comes from the extensive, fragmentary and often very detailed records kept for the activities of the royal workmen (who lived at the Deir el-Medina village), who cut the royal tombs in the Valleys of the Kings and Queens in Western Thebes, c. 1530-1100 B.C.

"Daily notes were kept for the men's attendances at work or of their absences from it. Sometimes reasons for absence are given. ... The entire workforce might be off for up to 8 or 14 days, especially if interruptions, official holidays and 'weekends' came together. In Ancient Egypt—as elsewhere—major national festivals (usually main feasts of chief gods) were also public holidays. Then, each main city had its own holidays on main feasts of the principal local god(s). Besides all this, the royal workmen at Deir el-Medina can be seen claiming time off for all kinds of reasons, including 'offering to his god,' '(off) for his feast'; even 'brewing for his feast' or for a specific deity. Not only individuals but groups of men together could get time off for such observances. And a full-scale feast could last several days.

"What was true in Thebes or Memphis would apply equally at Pi-Ramesse (Raamses). So, when Moses requested time off from Pharaoh, for the Hebrews to go off and celebrate a feast to the Lord God, it is perhaps not too surprising that Pharaoh's reaction was almost 'not another holiday!'"<sup>1</sup>

Pharaoh was not only "the king of Egypt" (v. 4), but the Egyptians regarded him as a divine person; he was worshipped as a god.<sup>2</sup> Consequently when Moses and Aaron asked Pharaoh

---

<sup>1</sup>Kenneth Kitchen, "Labour Conditions in the Egypt of the Exodus," *Buried History* (September 1984):47-48.

<sup>2</sup>See Frankfort, ch. 2: "The Egyptian State."

to obey the command of Yahweh, Pharaoh saw this request as a threat to his sovereignty. He knew (i.e., had respect for) the gods of Egypt, but he did "not know" (v. 2, have respect for) Yahweh, the God of his foreign slaves. If Yahweh had identified Himself with these slaves, and if He had not, by now, already delivered them, why should Pharaoh fear and obey Him?

"It required no ordinary daring to confront the representative of a long line of kings who had been taught to consider themselves as the representatives and equals of the gods. They were accustomed to receive Divine titles and honours, and to act as irresponsible despots. Their will was indisputable, and all the world seemed to exist for no other reason than [to] minister to their state."<sup>1</sup>

"These words ["Who is the LORD that I should obey His voice to let Israel go? I do not know the LORD ...," v. 2] form the motivation for the events that follow, events designed to demonstrate who the Lord is.

"Thus as the plague narratives begin, the purpose of the plagues is clearly stated: 'so that the Egyptians will know that I am the LORD' (7:5). Throughout the plague narratives we see the Egyptians learning precisely this lesson (8:19; 9:20, 27; 10:7). As the narratives progress, the larger purpose also emerges. The plagues which God had sent against the Egyptians were 'to be recounted to your son and your son's son ... so that you may know that I am the LORD.' [10:2]"<sup>2</sup>

"The point is clear from the chapter: when the people of God attempt to devote their full service

---

<sup>1</sup>Meyer, p. 88.

<sup>2</sup>Sailhamer, *The Pentateuch ...*, pp. 249-50.

and allegiance to God, they encounter opposition from the world."<sup>1</sup>

In their second appeal to Pharaoh, Moses and Aaron used milder terms (v. 3). They presented themselves not as ambassadors of Yahweh but as representatives of their brethren. They did not mention the name Yahweh, that was "unknown" to Pharaoh, or the name Israel, that would have struck him as arrogant. They did not command but requested ("Please ..."). Moreover, they gave reasons for their request: their God had appeared to them ("met with us"), and they feared His wrath if they disobeyed Him ("He will strike us with plague or with the sword").

"Moses ... appealed to him [Pharaoh] almost precisely as, centuries after, Paul addressed the assembly on Mars Hill ... [cf. Acts 17:22-23]."<sup>2</sup>

The Egyptians regarded the sacrifices that the Israelites would offer as unacceptable, since almost all forms of life were sacred in Egypt. They believed their gods manifested themselves through cows, goats, and many other animals.

"The Egyptians considered sacred the lion, the ox, the ram, the wolf, the dog, the cat, the ibis, the vulture, the falcon, the hippopotamus, the crocodile, the cobra, the dolphin, different varieties of fish, trees, and small animals, including the frog, scarab, locust, and other insects. In addition to these there were anthropomorphic gods; that is, men in the prime of life such as Annen, Atum, or Osiris."<sup>3</sup>

"Where did Moses get the idea that they should have a pilgrim feast and make sacrifices? God had only said they would serve Him in that mountain. In the OT the pilgrim feasts to the sanctuary three times a year incorporated the ideas of serving the

---

<sup>1</sup> *The NET2 Bible* note on 5:1.

<sup>2</sup> Meyer, p. 107.

<sup>3</sup> William Ward, *The Spirit of Ancient Egypt*, p. 123.



LORD and keeping the commands. So the words here use the more general idea of appearing before their God. They would go to the desert because there was no homeland yet. Moses later spoke of the journey as necessary to avoid offending Egyptian sensibilities (8:25-26)."<sup>1</sup>

Pharaoh's reply to Moses and Aaron's second appeal was even harsher than his response to their first command (v. 5; cf. v. 1). Their aggressive approach may have been what God initially used to cause Pharaoh to harden his heart.

5:10-21 "Straw" (v. 10) was the part of the corn or grain stalk that remained standing after field hands had harvested a crop. As punishment for Moses and Aaron's demand, Pharaoh required the Israelites to gather their own straw for brick-making. Previously, it had been provided for them. From then on, the Israelites had to find whatever suitable material they could to add to their bricks to strengthen them ("stubble," v. 12). Evidently they could not find enough straw.

"This Pharaoh, so unreasonable with men and so stingy with straw, is about to be shown up before Yahweh as no more than a man of straw."<sup>2</sup>

"An ancient Egyptian document, the Papyrus Anastasi, contains the lament of an officer who had to erect buildings on the frontier of Egypt, probably in the region of the present day Suez Canal. He could not work, for he says, 'I am without equipment. There are no people to make bricks, and there is no straw in the district.' This document, then, definitely indicates that the overseer of building operations could not progress in his work because of lack of straw for brickmaking."<sup>3</sup>

---

<sup>1</sup> *The NET2 Bible* note on 5:3.

<sup>2</sup> Durham, p. 66.

<sup>3</sup> Free, pp. 91-92.

"In 2:23 the cry of the people went up before God. By contrast, here in 5:15 the cry of the people is before Pharaoh. It is as if the author wants to show that Pharaoh was standing in God's way and thus provides another motivation for the plagues which follow."<sup>1</sup>

"The lowest ebbs go before the highest tides; and very cloudy mornings commonly introduce the fairest days, Deut. xxii. 36."<sup>2</sup>

The Israelites now turned on Moses, just as the Israelites in Jesus' day turned against *their* Savior.

"The Lord God brought a vine out of Egypt, but during the four hundred years of its sojourn there, it had undeniably become inveterately degenerate and wild."<sup>3</sup>

5:22—6:1 Moses' prayer of inquiry and complaint reveals the weakness of his faith at this time ("Lord, why have You brought harm to this people? Why did You ever send me? ... You have not rescued Your people at all." vv. 22-23). He, too, needed the demonstrations of God's power that followed.

"By allowing us to listen to Moses' prayer to God, the author uncovers Moses' own view of his calling. It was God's work, and Moses was sent by God to do it."<sup>4</sup>

This section climaxes with the apparent failure of Yahweh's plan to rescue Israel. This desperate scenario provides the pessimistic backdrop, and the bleak circumstances, for the supernatural demonstrations of Yahweh's power that follow.

"Man's extremity is God's opportunity of helping and saving."<sup>5</sup>

---

<sup>1</sup>Sailhamer, *The Pentateuch ...*, p. 250.

<sup>2</sup>Henry, p. 77. See also Enns, p. 161.

<sup>3</sup>Meyer, p. 18.

<sup>4</sup>Sailhamer, *The Pentateuch ...*, p. 250.

<sup>5</sup>Henry, p. 78.

## 2. Moses and Aaron's equipment as God's messengers 6:2—7:7

The writer gave the credentials of God and His representatives, Moses and Aaron, in these verses.

6:2-9      God explained to Moses that He would indeed deliver Israel out of Egypt—in spite of the discouragements that Moses had encountered so far. God proceeded to remind Moses of His promises to the patriarchs, and to reveal more of Himself by expounding another one of His names.

"During the patriarchal period the characteristic name of God was 'God Almighty' (6:3; see, for example, Gen. 17:1), the usual translation of the Hebrew *El Shaddai*, which probably literally means 'God, the Mountain One.' That phrase could refer to the mountains as God's symbolic home (see Ps. 121:1), but it more likely stresses His invincible power and might. ... But during the Mosaic period the characteristic name of God was to be 'the LORD,' the meaning of which was first revealed to Moses himself (Exod. 3:13-15). Exodus 6:3 is not saying that the patriarchs were totally ignorant of the name *Yahweh*."<sup>1</sup>

The occurrences of *El Shaddai* in Genesis are in 17:1; 28:3; 35:11; 43:14; 48:3; and partially in 49:3. The name occurs 30 times in Job. *Shaddai* may come from the Hebrew *sd* ("breast"), or from the Ugaritic *tdy* ("mountain"). In the former case, it would mean God the Nourisher, and in the latter God of the Mountain.<sup>2</sup>

"Thus though the name YHWH existed well before the time of Moses, the *meaning* of that name was not revealed until the time of Moses."<sup>3</sup>

---

<sup>1</sup>Youngblood, p. 41. Paragraph division omitted.

<sup>2</sup>See Kaiser, "Exodus," p. 340.

<sup>3</sup>Gianotti, p. 39. See Johnson, p. 56; Robert Dick Wilson, "Yahweh (Jehovah) and Exodus 6:3," in *Classical Evangelical Essays in Old Testament Interpretation*, pp. 29-40.

The name Yahweh reveals God as "the absolute Being working with unbounded freedom in the performance of His promises."<sup>1</sup> It emphasizes God's power at work for His people, as He was about to demonstrate it. This was a name by which the Israelites knew God; it was not a new name. The Israelites knew Yahweh, but they did not know him as they would know Him when He revealed Himself in the Exodus. Similarly, Pharaoh knew of Israel's God, but he did not know Him as he was about to in the Exodus (cf. 1:8; 5:2).

"... the *significance* of the name is going to be understood at this most pivotal time in Israel's history."<sup>2</sup>

"Whatever the situation or need (in particular, the redemption from Egypt, but also future needs), God will 'become' the solution to that need."<sup>3</sup>

Moses was having a terrible day; things seemed to be going from bad to worse, but the LORD reminded Moses five times to keep focused on who He was (vv. 2, 6, 7, 8, 29).

"Time after time He punctuated His message to Moses by saying, 'Look, Moses, your eyes are in the wrong place (again). Get our eyes back on Me (again). Remember who I am (again).'"<sup>4</sup>

"Until your eyes are fixed on the Lord, you will not be able to endure those days that go from bad to worse."<sup>5</sup>

The LORD reminded Moses four times that He was "I am" (vv. 2, 6, 7, 8), and He told him eight times "I will" (vv. 1, 6 [3 times], 7 [twice], and 8 [twice]). In this revelation (vv. 1-8), God promised to do three things for Israel:

---

<sup>1</sup>Keil and Delitzsch, 1:467.

<sup>2</sup>Enns, p. 174.

<sup>3</sup>Gianotti, p. 46. See also the note on verse 3 in the NET Bible.

<sup>4</sup>Swindoll, *Moses ...*, p. 165.

<sup>5</sup>*Ibid.* Italics omitted.

1. He would deliver the Israelites from their Egyptian bondage (v. 6). Moses communicated this in a threefold expression, suggesting the completeness of the deliverance: "I will bring you out from under the labors of the Egyptians ... I will rescue you from their bondage ... I will redeem you with an outstretched arm, and with great judgments."
2. He would adopt Israel as His nation ("I will take you as My people, and I will be your God; and you shall know that I am the LORD your God, who brought you out from under the labors of the Egyptians," v. 7). This took place at Sinai (19:5).
3. He would bring Israel into the Promised Land ("I will bring you to the land which I swore to give to Abraham, Isaac, and Jacob, and I will give it to you as a possession," v. 8). This took place after the Israelites entered Canaan.

The phrase "I will" occurs seven times in these three verses, emphasizing the fact that God would certainly do these things for Israel. The Jews regarded seven as the symbolical number of God's covenant—based on the Creation account.<sup>1</sup> The whole revelation occurs within the bookend statements: "I am the LORD" (vv. 2, 8), which formalize and further stress the certainty of these promises.

"So this passage effectively paves the way for the transition from the simple covenant with Abraham to the complex new (Mosaic) covenant with the people as a whole."<sup>2</sup>

"This small section of narrative [vv. 1-8] also sketches out the argument of the whole Pentateuch. God made a covenant with the patriarchs to give them the land of Canaan (Ex 6:4). He remembered his covenant when he heard the cry of the Israelites in Egyptian bondage (v.

---

<sup>1</sup>Alfred Edersheim, *The Temple*, p. 132, f. 1.

<sup>2</sup>Jonathan Magonet, "The Rhetoric of God: Exodus 6:2-8," *Journal for the Study of the Old Testament* 27 (October 1983):66.

5). He is now going to deliver Israel from their bondage and take them to himself as a people and be their God (v. 6). He will also bring them into the land which he swore to give to their fathers (v. 8). The die is cast for the remainder of the events narrated in the Pentateuch."<sup>1</sup>

6:10-13 Moses continued to claim lack of persuasive skill in speech ("I am unskilled in speech," v. 12; cf. v. 30). He failed to grasp the full significance of what God had just revealed to him. Jesus' disciples, and we, had and have the same problem. It was God, not Moses, who would bring the people out of Egypt.

"Seven distinct objections were raised by Moses as reasons why he should not undertake the arduous task to which he was called. They have been thus epitomised [*sic*]: Lack of fitness, 'who am I, that I should go?' (iii. 11); lack of words, 'what shall I say?' (iii. 13); lack of authority, 'they will not believe me' (iv. 1); lack of power of speech, 'I am not eloquent' (iv. 10); lack of special adaptation, 'Send by whom Thou wilt send' (iv. 13); lack of success at his first attempt, 'neither hast Thou delivered Thy people at all' (v. 23); lack of acceptance, 'the children of Israel have not hearkened unto me' (vi. 12)."<sup>2</sup>

6:14-27 The selective genealogy (cf. Num. 3:27-28) of Moses and Aaron in these verses accredits these men as God's divinely appointed messengers to the Israelites. Clearly there were many generations between Levi and Moses, since the Israelites spent 430 years in Egypt between Levi and Moses.<sup>3</sup> Moses' father, Amram, married his father's sister, Jochebed ("God Is Your Glory"). She must have been a remarkable woman.<sup>4</sup>

---

<sup>1</sup>Sailhamer, *The Pentateuch ...*, p. 251.

<sup>2</sup>Meyer, p. 62.

<sup>3</sup>See Archer, *Encyclopedia of ...*, pp. 111-12.

<sup>4</sup>See Alexander Whyte, *Bible Characters*, 1:142-43.

"The point of this genealogy *in this context* seems to be to establish Aaron as a worthy partner in the deliverance of Israel from Egypt, particularly in his role as Moses' mouthpiece—a role reiterated in 6:28—7:7."<sup>1</sup>

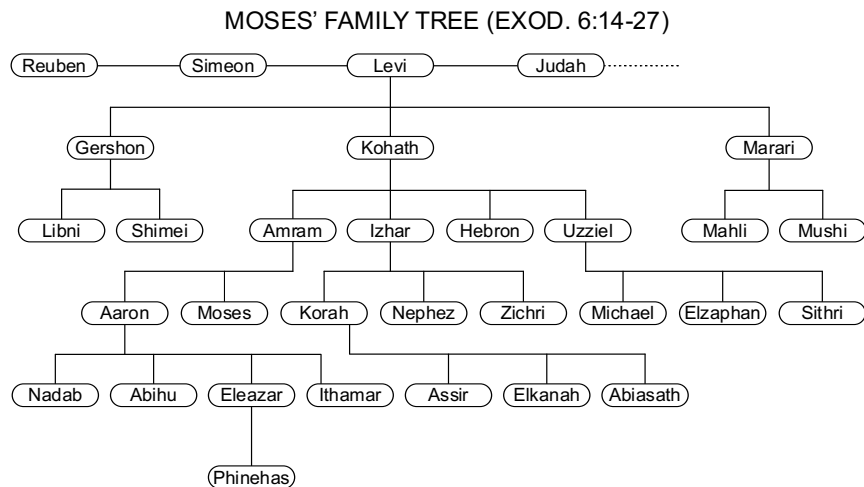

Verses 26 and 27 sound like the comments of a historian other than Moses, but it is possible that Moses could have written these words, as comparison with other contemporary writings has shown (cf. 16:33-36).<sup>2</sup>

6:28-30 These verses essentially repeat 6:10-12. They emphasize that it was the LORD who was sending Moses to Pharaoh ("I am the LORD, say to Pharaoh king of Egypt all that I say to you," v. 29), and they repeat Moses' excuse for not going ("I am unskilled in speech," v. 30).

7:1-7 Moses was "as God" to Pharaoh (v. 1), in that he was the person who revealed God's will and sovereignly gave Pharaoh orders. Pharaoh was to be the executor of that will.

"In Egyptian royal ideology, the pharaoh was considered to be a divine being. So by calling Moses God, Yahweh is beating Pharaoh at his own

<sup>1</sup>Enns, p. 178.

<sup>2</sup>See Archer, *Encyclopedia of ...*, pp. 112-13.

game. It is not the king of Egypt who is god; rather, it is this shepherd and leader of slaves who is God."<sup>1</sup>

Aaron would be Moses' "prophet" as he stood between Moses and Pharaoh, and communicated Moses' and God's will to the king. Prophets, in the Bible, are people who communicate revelations from God to people. Verse 1 helps us identify the essential meaning of the Hebrew word *nabhi* ("prophet"; cf. 4:10-16; Deut. 18:15-22; Isa. 6:9; Jer. 1:7; Ezek. 2:3-4; Amos 7:12-16). This word occurs almost 300 times in the Old Testament, and "in its fullest significance meant 'to speak fervently for God.'"<sup>2</sup>

"The pith of Hebrew prophecy is not prediction or social reform but the declaration of divine will."<sup>3</sup>

Verses 1 and 2 repeat 4:10-17. Repetition is a feature of Hebrew prose that strengthens emphasis. God referred to the miracles Moses would do as "signs" (i.e., miracles with special significance) and "wonders" (miracles producing wonder or awe in those who witnessed them, v. 3).<sup>4</sup> The text usually calls them "plagues," but clearly they were also "signs"—miracles that signified God's sovereignty.

The ultimate purpose of God's actions was His own glory ("Then the Egyptians shall know that I am the LORD," v. 5). The glory of God was at stake in the plagues. The Egyptians would acknowledge God's faithfulness and sovereign power—in His delivering the Israelites from their bondage and fulfilling their holy calling. God's intention was to bless the Egyptians through Israel (Gen. 12:3), but Pharaoh would make that impossible by his stubborn refusal to honor God. Nevertheless the Egyptians

---

<sup>1</sup>Enns, p. 181.

<sup>2</sup>Leon J. Wood, *The Prophets of Israel*, p. 63. See also Hodge, 2:462.

<sup>3</sup>Norman Gottwald, *A Light to the Nations*, p. 277. See also Edward J. Young, *My Servants the Prophets*, ch. III: "The Terminology of Prophetism," for discussion of how the Old Testament used the Hebrew words for prophets.

<sup>4</sup>See Ken L. Sarles, "An Appraisal of the Signs and Wonders Movement," *Bibliotheca Sacra* 145:577 (January-March 1988):57-82.



would, in the final analysis, acknowledge Yahweh's sovereignty.<sup>1</sup>

The writer included the ages of Moses and Aaron (80 and 83 respectively) as part of God's formal certification of His messengers (v. 7).<sup>2</sup>

"It is a common feature of biblical narratives for the age of their heroes to be stated at the time when some momentous event befalls them ..."<sup>3</sup>

"D. L. Moody wittily said that Moses spent forty years in Pharaoh's court thinking he was somebody; forty years in the desert learning he was nobody; and forty years showing what God can do with somebody who found out he was nobody."<sup>4</sup>

### **3. The attestation of Moses and Aaron's divine mission 7:8-13**

Earlier, God gave three signs to the Israelites to authenticate Moses as God's spokesman: Moses' staff became a serpent, his hand became leprous and then normal, and water from the Nile became blood (4:1-9). Now, God gave 10 plagues to the Egyptians (primarily), to authenticate Himself as the only true God.<sup>5</sup> But before the plagues began, Moses performed another sign—Aaron's staff became a serpent—before Pharaoh, to authenticate Moses and Aaron as His spokesmen.

"What we refer to as the ten 'plagues' were actually judgments designed to authenticate Moses as God's messenger and his message as God's message. Their ultimate purpose was to reveal the greatness of the power and authority of God to the

---

<sup>1</sup>Kaiser, "Exodus," pp. 348-49. Cf. C. J. Labuschagne, *The Incomparability of Yahweh in the Old Testament*, pp. 74-75, 92-94.

<sup>2</sup>See G. Herbert Livingston, "A Case Study of the Call of Moses," *Asbury Theological Journal* 42:2 (Fall 1987):89-113.

<sup>3</sup>Cassuto, pp. 90-91.

<sup>4</sup>Bernard Ramm, *His Way Out*, p. 54.

<sup>5</sup>See Bruce K. Waltke, *An Old Testament Theology*, p. 379, for a table showing the literary structure of the plagues.

Egyptians (7:10—12:36) in order to bring Pharaoh and the Egyptians into subjection to God."<sup>1</sup>

Pharaoh requested that Moses and Aaron perform "a miracle" to prove their divine authority, since they claimed that God had sent them (vv. 9-10).

The Jews preserved the names of the chief "soothsayer priests" (v. 11), even though the Old Testament did not record them. Paul said they were Jannes and Jambres (2 Tim. 3:9). These were not sleight-of-hand artists, but "wise men" and "sorcerers" who were evidently members of the priestly caste (cf. Gen. 41:8). Other English translations call these men "magicians" (NIV, TNIV, HCSB, AV, NKJV, NRSV, ESV, NEB, CEV). The power of their demonic gods lay in their "secret arts" (v. 11). They were able to do miracles with the power of Satan (1 Cor. 10:20; cf. Matt. 24:24; 2 Thess. 2:9-10; Rev. 13:13-14).<sup>2</sup> The superiority of the Israelites' God is clearly shown in the superiority of Aaron's serpent over those of the Egyptian magicians (v. 12). Aaron's staff, again, represented regal authority, and implied that Yahweh, not Pharaoh, was sovereign (cf. 4:2-5).

There are at least four possibilities regarding the Egyptian magicians' rods becoming snakes: First, the magicians may have received power to create animal life from Satan, with God's permission. This seems unlikely, since there is no other evidence that Satan can create living beings. Second, God may have given the sorcerers this power directly. This is possible, though there is no other evidence of God doing this elsewhere in Scripture. Third, their rods may have actually been rigid snakes that, when cast to the ground, were seen to be what they were: serpents. In this case, Pharaoh's sorcerers may have drugged or somehow stunned the serpents so that they only appeared to be rods. This seems possible, though the sorcerers appear to have had genuine Satanic power when they changed the water of the Nile into blood (v. 22). Fourth, the sorcerers may have received their power to do miracles from Satan. This seems most probable, since there are other instances in Scripture of unbelievers performing "miracles" (e.g., Acts 8:9-11; 13:6-11).

---

<sup>1</sup>J. Dwight Pentecost, *Thy Kingdom Come*, p. 83.

<sup>2</sup>See Merrill F. Unger, *Biblical Demonology*, p. 139; idem, *Demons in the World Today*, pp. 38-39, 75-96; Kurt E. Koch, *Between Christ and Satan*, pp. 70-122.

One interpreter believed the Hebrew word *tannin* ("serpent," cf. Deut. 32:33; Ps. 91:13; Isa. 27:1) should be translated "crocodile."<sup>1</sup> It is also translated "sea creature" (Gen. 1:21), "sea monster" (Job 7:12; Ps. 74:13; 148:7), "dragon" (Neh. 2:13; Isa. 51:9), "monster" (Jer. 51:34), and "jackal" (Lam. 4:3) in the NASB. Probably these were regular snakes, which were symbols of the Egyptian royalty.

"The Hebrew word translated 'to swallow' (*bala*) is used in Exodus only here and in 15:12, where the sea swallows up the Egyptian army. The final demise of the Egyptians is already hinted at in 7:13."<sup>2</sup>

In Genesis 1, God overcame chaos when He created the universe. The Hebrew word *tannin* often referred to the chaotic forces that God overcame in creation—in the Old Testament and in ancient Near Eastern literature. Thus Aaron's staff (turned serpent) swallowing up the Egyptians' serpents appears to be another example of the theme of God overcoming chaos. There are several recurrences of this theme in the plagues that follow. In them we have a series of creation reversals.

"The theological significance of turning a staff into a snake is that, like the plagues to follow, it is a manipulation of nature. God battles Egypt by controlling creation; it does his bidding."<sup>3</sup>

Aaron's miracle should have convinced Pharaoh of Yahweh's sovereignty, but he chose to harden his heart in unbelief and disobedience. Consequently, God sent the plagues that followed.

"The point of this brief section is that Yahweh's proof of his powerful Presence to the Pharaoh and thus to the Pharaoh's Egypt will be miraculous in nature."<sup>4</sup>

#### **4. The first three plagues 7:14—8:19**

Psalm 78:43 places the scene of the plagues in northern Egypt near Zoan.<sup>5</sup>

---

<sup>1</sup>McGee, 1:223.

<sup>2</sup>Enns, p. 196.

<sup>3</sup>Ibid., p. 197.

<sup>4</sup>Durham, p. 92.

<sup>5</sup>See the map of Egypt earlier in these notes.

God had announced His overall purpose for the plagues in 7:4-5. In addition, God sent the plagues to give Pharaoh the opportunity to obey Yahweh, as well as punishing him for his refusal to obey God. The LORD also used the plagues to teach the Israelites that He is the only true and living God. Ezekiel 20:1-9 tells us that some of the Israelites had begun to worship the gods of Egypt. Psalm 106:7 says that they did not understand God's wonders in Egypt or remember His many mercies.

The plagues involved natural occurrences, rather than completely unknown phenomena. At various times of the year gnats, flies, frogs, etc., were a problem to the Egyptians. Even the pollution of the Nile, darkness, and death were common to the Egyptians.

Some interpreters have concluded that the plagues, the parting of the Red Sea, and the pillar of cloud and fire were the result of purely natural occurrences, such as the appearance of a comet.<sup>1</sup> However, evidence that the plagues were not just phenomena of nature, devoid of any supernatural element, is as follows: (1) Some were natural calamities that God supernaturally intensified (frogs, insects, murrain, hail, darkness). (2) Moses set the time for the arrival and departure of some of the plagues. (3) Some plagues afflicted only the Egyptians. (4) The severity of the plagues increased consistently. (5) The plagues also had a moral purpose (9:27; 10:16; 12:12; 14:30).<sup>2</sup>

"The plagues were a combination of natural phenomena known to both the Egyptians and Israelites alike (due to their long sojourn in Egypt) heightened by the addition of supernatural factors."<sup>3</sup>

This was the first of four periods in biblical history when God intervened in human affairs with miracles. This period continued through the ministry of Joshua. The others periods were: the time of Elijah and Elisha, the time of Christ and the apostles, and the time of the two witnesses in the Tribulation. God has done miracles throughout history, and He still does miracles today. But these were periods when He gave select individuals the ability to do them in order to authenticate His messages. Here the plagues were signs to Pharaoh and the Egyptians that the God of the Israelites had

---

<sup>1</sup>E.g., Immanuel Velikovsky, *Worlds in Collision*, pp. 63-104, 181.

<sup>2</sup>Free, p. 95.

<sup>3</sup>Ramm, p. 62.

spoken. God designed these miracles to teach the Egyptians that Yahweh sovereignly controls the forces of nature (i.e., everything).<sup>1</sup> The Egyptians, however, attributed this control to their gods.

"Until now the dominant theme has been on preparing the deliverer [Moses] for the exodus. From here the account will focus on preparing Pharaoh for it. The theological emphasis for exposition of the entire series of plagues may be: The sovereign Lord is fully able to deliver his people from the oppression of the world so that they may worship and serve him alone."<sup>2</sup>

Some writers have offered a possible schedule for the plagues, based on the times of year certain events mentioned in the text would have normally taken place in Egypt. For example, lice and flies normally appeared in the hottest summer months. Barley formed into ears of grain, and flax budded (9:31) in January-February. Locusts were a problem in early spring. Furthermore, the Jews continued, after the Exodus, to celebrate the Passover in the spring. This schedule suggests that the plagues may have begun in June and ended the following April.<sup>3</sup>

"The Egyptians were just about the most polytheistic people known from the ancient world. Even to this day we are not completely sure of the total number of gods which they worshipped. Most lists include somewhere in the neighborhood of eighty gods ..."<sup>4</sup>

Many students of the plagues have noticed that they appeared in sets of three. The accounts of the first plague in each set (the first, fourth, and seventh plagues) each contain a purpose statement in which God explained to Moses His reason and aim for that set of plagues (cf. 7:17; 8:22; 9:14). These plagues also all took place in the morning, possibly suggesting a new

---

<sup>1</sup>See R. Norman Whybray, *Introduction to the Pentateuch*, p. 72; Sailhamer, *The Pentateuch ...*, pp. 252-53.

<sup>2</sup>The NET2 Bible note on 7:14.

<sup>3</sup>Flinders Petrie, *Egypt and Israel*, pp. 35-36; and Greta Hort, "The Plagues of Egypt," *Zeitschrift für die Alttestamentliche Wissenschaft* 69 (1957):84-103; *ibid.*, 70 (1958):48-59.

<sup>4</sup>Davis, p. 86. Cf. Frankfort, p. 4. Other studies have discovered more than 1,200 gods. See E. A. W. Budge, *The Gods of the Egyptians*, pp. ix-x; B. E. Shafer, ed., *Religion in Ancient Egypt: Gods, Myths, and Personal Practice*, pp. 7-87.

beginning. The last plague in each set of three came on Pharaoh without warning, but Moses announced the others to him beforehand. The first set of three plagues apparently affected both the Egyptians and the Israelites, whereas the others evidently touched only the Egyptians.

The plagues became increasingly destructive to the Egyptians, and thus gave them a growing appreciation for Yahweh's sovereignty. The first three caused inconvenience, the second three were more annoying, the third three proved costly, and the last one was devastating. The first, second, and fourth plagues involved the Nile River, Egypt's lifeline. The Egyptian sorcerers were able to duplicate only the first two plagues, but not the remaining eight, and in the sixth one they were incapacitated and could not stand. Pharaoh granted Moses some permission after the second, fourth, sixth, seventh, eighth, ninth, and tenth plagues, reflecting their growing severity. Only the last and worst plague involved a divinely sent angel who executed God's will. God accomplished all the previous ones through Moses and Aaron.<sup>1</sup>

### **The water turned to blood (the first plague) 7:14-25**

The first mighty act of God serves in the narrative as a paradigm (typical example, pattern) of the nine plagues that follow. The beginning and ending of Israel's deliverance involved a mighty act of God involving water: the water turned to blood, and the drowning of the Egyptian army in the Red Sea. These events bracket the story of Israel's deliverance.

Striking the Nile with the rod suggested dominion over creation and all the gods of Egyptian mythology. The Egyptians linked many of their gods with the life-giving force of the Nile. The tenth plague is unique, in that it is both a part of the narrative of Exodus as a whole, and is a mighty act of God in itself.<sup>2</sup>

Evidently Pharaoh had his "morning devotions" on the bank of the sacred Nile River. Bathing in the Nile supposedly empowered Pharaoh.<sup>3</sup> Moses and Aaron met him there as he prepared to honor the gods of the river (v. 15).

---

<sup>1</sup>See Kaiser, "Exodus," revised ed., pp. 398-99, for comparisons of the plagues.

<sup>2</sup>Durham, p. 95.

<sup>3</sup>*The Nelson ...*, p. 110.

"That creature which we idolize God justly removes from us, or embitters to us. He makes that a scourge to us which we make a competitor with him."<sup>1</sup>

We could perhaps interpret the statement that "all the water that was in the Nile was turned into blood" (v. 20) in the same way we interpret Joel's prophecy that "the moon" will be turned "into blood" (Joel 2:31 cf. Rev. 6:12). Moses may have meant that the water appeared to be blood.<sup>2</sup> Nevertheless something happened to the water to make the fish die (v. 21). The Hebrew word translated blood means blood, so a literal meaning is possible.<sup>3</sup> Furthermore, the passage in Joel is poetry, and therefore figurative, whereas the passage here in Exodus is narrative, and may be understood literally.<sup>4</sup> Note, too, that this plague affected all the water in pools and reservoirs formed by the overflowing Nile, as well as the water in other rivers and streams in Egypt (v. 19). The people could not drink the water, and the blood was "through all the land of Egypt," not just near where Moses and Pharaoh stood (v. 21).

Arguments for the Nile not turning to literal blood follow:

"(1) The first nine plagues form a set. Each of these is a natural event that occurs in a miraculous way, in quantity or timing. The change of the waters into blood would not be a natural event. (2) The plagues grow in severity with each successive one, coming to a climax with the tenth. A change of the water to actual blood would be out of step with this pattern. (3) The Hebrew word translated *blood* can refer to a red color, as in Joel 2:31. An appropriate miracle of natural timing might be that God caused torrential rains to flood and pollute the sources of the Nile to create this plague at the time it was needed. Red soil and algae would make the waters of the Nile red, unfit for drinking and deficient in oxygen for the fish."<sup>5</sup>

Understood figuratively or literally, either way, a real miracle took place, as is clear from the destructive effects this plague had on the Egyptians and

---

<sup>1</sup>Henry, p. 79.

<sup>2</sup>*The New Bible Dictionary*, s.v. "Plagues of Egypt," by Kenneth A. Kitchen, pp. 1001-3.

<sup>3</sup>Durham, p. 97.

<sup>4</sup>Sailhamer, *The Pentateuch ...*, p. 254.

<sup>5</sup>*The Nelson ...*, p. 110.

on the fish. The Egyptian sorcerers were seemingly able to duplicate this wonder, but they could not undo its effects.

"The explanation for this apparent duplication must be sought in one of two directions. One is trickery. ... The other is demonic power."<sup>1</sup>

"Perhaps the tricksters of Pharaoh were able secretly to color containers of water in an attempt to duplicate the sign of the Lord in the Nile River (7:11)."<sup>2</sup>

"The most that can be said for their miracle-working is that it is a copy of what Moses and Aaron have accomplished and that it actually makes matters worse for their master and their people."<sup>3</sup>

"It was appropriate that the first of the plagues should be directed against the Nile River itself, the very lifeline of Egypt and the center of many of its religious ideas. The Nile was considered sacred by the Egyptians. Many of their gods were associated either directly or indirectly with this river and its productivity. For example, the great Khnum was considered the guardian of the Nile sources. Hapi was believed to be the 'spirit of the Nile' and its 'dynamic essence.' One of the greatest gods revered in Egypt was the god Osiris who was the god of the underworld. The Egyptians believed that the river Nile was his bloodstream. In the light of this latter expression, it is appropriate indeed that the Lord should turn the Nile to blood! It is not only said that the fish in the river died but that the 'river stank,' and the Egyptians were not able to use the water of that river. That statement is especially significant in the light of the expressions which occur in the 'Hymn to the Nile': 'The bringer of food, rich in provisions, creator of all good, lord of majesty, sweet of fragrance'.<sup>4</sup> With this Egyptian literature in mind, one can well imagine the horror and frustration of the people of Egypt as they looked upon that

---

<sup>1</sup>Wood, *A Survey ...*, pp. 124-25.

<sup>2</sup>*The Nelson ...*, p. 110.

<sup>3</sup>Durham, p. 98.

<sup>4</sup>James B. Pritchard, ed., *Ancient Near Eastern Texts Relating to the Old Testament*, p. 272.



which was formerly beautiful only to find dead fish lining the shores and an ugly red characterizing what had before provided life and attraction. Crocodiles were forced to leave the Nile. One wonders what worshipers would have thought of Hapi the god of the Nile who was sometimes manifest in the crocodile. Pierre Montet relates the following significant observation:

"At Sumenu (the modern Rizeigat) in the Thebes area, and in the central district of the Fayum, the god Sepek took the form of a crocodile. He was worshipped in his temple where his statue was erected, and venerated as a sacred animal as he splashed about in his pool. A lady of high rank would kneel down and, without the slightest trace of disgust, would drink from the pool in which the crocodile wallowed. Ordinary crocodiles were mummified throughout the whole of Egypt and placed in underground caverns, like the one called the Cavern of the Crocodiles in middle Egypt.<sup>1</sup>

"Surely the pollution of the Nile would have taken on religious implications for the average Egyptian. Those who venerated Neith, the eloquent warlike goddess who took a special interest in the *lates*, the largest fish to be found in the Nile, would have had second thoughts about the power of that goddess. Nathor was supposed to have protected the *chromis*, a slightly smaller fish. Those Egyptians who depended heavily on fish and on the Nile would indeed have found great frustration in a plague of this nature."<sup>2</sup>

"Each year, toward the end of June, when the waters of the Nile begin to rise, they are colored a dark red by the silt carried down from the headwaters. This continues for three months, until the waters begin to abate, but the water, meanwhile, is wholesome and drinkable. The miracle of 7:17-21 involved three elements by which it differed from the accustomed phenomenon: the water was changed by the smiting of Moses'

---

<sup>1</sup>Pierre Montet, *Eternal Egypt*, p. 172.

<sup>2</sup>Davis, pp. 94-95.

rod; the water became undrinkable; and the condition lasted just seven days (v. 25)."<sup>1</sup>

The commentators have interpreted the reference to blood being throughout all Egypt "in containers of wood and in containers of stone" (v. 19) in various ways: Some believe this refers to water in exterior wooden and stone water containers. Others think it refers to water in all kinds of vessels used for holding water. Still others believe Moses described the water in trees and in wells. However, this expression could refer to the water kept in buildings, which the Egyptians normally constructed out of wood and stone.

"In the Bible a totality is more often indicated by mentioning two fundamental elements; see e.g., 'milk and honey' (Ex. iii 8, etc.) and 'flesh and blood' (Matt. xvi 17)."<sup>2</sup>

"In containers of wood and in containers of stone" may be a synecdoche, a figure of speech in which a part stands for the whole or the whole represents a part. It may be that God even changed the water stored in buildings to blood.

"It is fitting that the means by which the first pharaoh tried to exterminate the Israelite threat—casting them into the Nile (1:22)—should now become a source of trouble for the Egyptians."<sup>3</sup>

"Each of the first nine of the mighty-act accounts may be said to have the same fundamental point, expressed in much the same way. That point, concisely summarized, is that Yahweh powerfully demonstrates his Presence to a Pharaoh prevented from believing so that Israel may come to full belief."<sup>4</sup>

### **Frogs (the second plague) 8:1-15**

Before the second plague began, Moses gave Pharaoh a warning (v. 2), for the first time, and for the first time the plague touched Pharaoh's person.

---

<sup>1</sup>Johnson, p. 58.

<sup>2</sup>Cornelis Houtman, "On the Meaning of Uba'esim Uba'abanim in Exodus VII 19," *Vetus Testamentum* 36:3 (1968):352.

<sup>3</sup>Enns, pp. 199-200.

<sup>4</sup>Durham, p. 99.

"The god Hapi controlled the alluvial deposits and the waters that made the land fertile and guaranteed the harvest of the coming season. These associations caused the Egyptians to deify the frog and make the theophany of the goddess Heqt a frog. Heqt was the wife of the great god Khnum. She was the symbol of resurrection and the emblem of fertility. It was also believed that Heqt assisted women in childbirth. ... The frog was one of a number of sacred animals that might not be intentionally killed, and even their involuntary slaughter was often punished with death."<sup>1</sup>

The goddess Heqt "... who is depicted in the form of a woman with a frog's head, was held to blow the breath of life into the nostrils of the bodies that her husband fashioned on the potter's wheel from the dust of the earth ..."<sup>2</sup>

"This second plague was not completely unrelated to the first, for the Nile and the appearance of the frogs were very much associated. The presence of the frogs normally would have been something pleasant and desirable, but on this occasion quite the opposite was true. The frogs came out of the rivers in great abundance and moved across the land into the houses, the bedchambers, the beds, and even moved upon the people themselves (v. 3). One can only imagine the frustration brought by such a multiplication of these creatures. They were probably everywhere underfoot bringing distress to the housewives who attempted to clear the house of them only to find that they made their way into the kneading troughs and even into the beds. It must have been a unique experience indeed to come home from a long day's work, slip into bed only to find that it has already been occupied by slimy, cold frogs! Whatever popularity the goddess Heqt must have enjoyed prior to this time would have been greatly diminished with the multiplication of these creatures who at this point must have tormented her devotees to no end."<sup>3</sup>

---

<sup>1</sup>Davis, p. 100.

<sup>2</sup>Cassuto, p. 101.

<sup>3</sup>Davis, pp. 100-101.

"Since the frog or toad was deified as the Egyptian goddess Heqt, who was believed to assist women in childbirth, there may be a touch of irony in the statement that large numbers of frogs would invade the Pharaoh's bedroom and even jump on his bed (v. 3)."<sup>1</sup>

"A plague of frogs can be understood as an attack on the Egyptian fertility goddess for the Egyptians' previous attempt at eradicating the Israelites' male infant population (Ex. 1)."<sup>2</sup>

Aaron's rod ("staff," v. 5) was not a magician's wand; it was a symbol of God's mighty power in the hand of His servant (cf. 4:1-8, 20; 7:9, 20; 8:16; 9:23; 10:13, 22; 14:16; 17:5, 9). The Egyptian magicians were able to bring up frogs, too (v. 7), but they seem to have lacked the ability to make them go away, since Pharaoh asked Moses to get rid of them (v. 8). Pharaoh himself lacked this power. The cessation of these plagues was as much a sign of Yahweh's power as the plagues themselves.

"They [the magicians] would better have shown their power by removing the frogs."<sup>3</sup>

How the Egyptian magicians produced the frogs is a mystery, but it seems that this was not just sleight-of-hand trickery. This may be an argument to support the view that all of the magicians' "miracles" were supernatural (cf. 2 Thess. 2:9).<sup>4</sup> Satanic power does not generally work for the welfare of humanity but is basically destructive.

To impress upon Pharaoh that a personal God was performing these miraculous plagues (v. 10), Moses asked the king to set the time when the frogs should depart (v. 9). Yahweh was in charge of the very territory over which Pharaoh regarded himself as sovereign.

Here is another example of a reversal of creation. Man was created to rule over the animals, but here animals dominated people.

---

<sup>1</sup>Youngblood, p. 54.

<sup>2</sup>Enns, p. 205.

<sup>3</sup>Jamieson, et al., p. 60.

<sup>4</sup>See Archer, *Encyclopedia of ...*, p. 113.

### Gnats (the third plague) 8:16-19

The Hebrew word translated "gnats" (*kinnim*) probably refers, not to lice (AV, NKJV) or fleas, but to gnats (ESV, NRSV, HCSB, NIV, TNIV, CEV). The NEB has "maggots." A gnat is a small two-winged fly that resembles a mosquito. Kaiser suggested that mosquitoes may be in view.<sup>1</sup> The frogs had invaded the Egyptians' homes, but the gnats afflicted their bodies.

They were "... a species of gnats, so small as to be hardly visible to the eye, but with a sting which, according to Philo and Origin, causes a most painful irritation of the skin. They even creep into the eyes and nose, and after the harvest they rise in great swarms from the inundated rice fields."<sup>2</sup>

"The dust of the earth turned into gnats" (v. 17) probably means that the gnats rose from the dust, resembled the dust in that they were so small, and were as numerous as the dust. Moses evidently used the language of appearance (here a metaphor).

"The dust, to which all flesh must return, becomes an instrument that speeds the Egyptians on toward that inexorable end."<sup>3</sup>

The gnats covered "all the land of Egypt" (v. 17) and "every person and animal" (v. 18). They may have afflicted the Israelites as well, since in the record of the following plagues, it is specifically stated that God did not send those plagues on the Israelites (vv. 22-23; 9:4, 6, 26). Therefore, later references to the plagues affecting "all the land of Egypt" (v. 24; 9:9, 25; 10:14, 21) should probably be understood as excluding Goshen, where the Israelites lived.

The first three plagues involved the three sections of the ecosystem: water, land, and air. God controls them all.

The magicians failed to reproduce this miracle (v. 18). They had to confess that it was of divine origin and not the result of Moses and Aaron's human ability. The "finger of God" (v. 19) is a phrase denoting creative omnipotence in Scripture (31:18; Ps. 8:3; Luke 11:20). It is probably

---

<sup>1</sup>Kaiser, "Exodus," p. 353.

<sup>2</sup>Keil and Delitzsch, 1:483.

<sup>3</sup>Enns, p. 209.

another synecdoche (one part representing the whole), as well as an anthropomorphism (a depiction of God in human terms). Here the "finger of God," a part, represents the totality, namely, all His power. See 1 Samuel 6:9 and Psalm 109:27, where the "hand of God" also pictures His power.

"The new element introduced in the account of the third of the mighty acts is the realization by Pharaoh's learned men that God or a god is in the midst of what is happening in Egypt."<sup>1</sup>

"At this point in the narrative we, the readers, see that the Egyptian magicians were using tricks in their earlier signs. Their confession plays an important role in uncovering the writer's real purpose in recounting these events."<sup>2</sup>

The magicians gave credit to "God" ([or "gods," *Elohim*), not Yahweh. They did not ascribe this miracle to the God of the Israelites, but were only willing to say that it had some supernatural origin.

"It is not clear against what specific deities this particular plague was directed. It is entirely possible, however, that the plague was designed to humiliate the official priesthood in the land, for it will be noted in verse 17 that these creatures irritated both man and beast, and this included 'all the land of Egypt.' The priests in Egypt were noted for their physical purity. Daily rites were performed by a group of priests known as the *Uab* or 'pure ones.' Their purity was basically physical rather than spiritual. They were circumcised, shaved the hair from their heads and bodies, washed frequently, and were dressed in beautiful linen robes.<sup>3</sup> In the light of this it would seem rather doubtful that the priesthood in Egypt could function very effectively having been polluted by the presence of these insects. They, like their worshipers, were inflicted with the pestilence of this occasion. Their prayers were made ineffective by their own personal impurity with the presence of gnats on their bodies.

---

<sup>1</sup>Durham, p. 109.

<sup>2</sup>Sailhamer, *The Pentateuch ...*, p. 255.

<sup>3</sup>Montet, p. 177. See also G. Herbert Livingston, *The Pentateuch in its Cultural Environment*, p. 107.

"The priests in Egypt were a group of people to be reckoned with not only religiously but economically and politically. They controlled to a large degree, the minds and hearts of the people."<sup>1</sup>

The Egyptian priests wore animal masks representing various gods, to help the people understand which god the mask portrayed, and their activities.<sup>2</sup> This practice continues in some pagan religions even today.

### 5. The fourth, fifth, and sixth plagues 8:20—9:12

"As the Egyptian magicians saw nothing more than the finger of God in the miracle which they could not imitate, that is to say, the work of some deity, possibly one of the gods of the Egyptians, and not the hand of Jehovah the God of the Hebrews, who had demanded the release of Israel, a distinction was made in the plagues which followed between the Israelites and the Egyptians, and the former were exempted from the plagues: a fact which was sufficient to prove to anyone that they came from the God of Israel. To make this the more obvious, the fourth and fifth plagues were merely announced by Moses to the king. They were not brought on through the mediation of either himself or Aaron, but were sent by Jehovah at the appointed time; no doubt for the simple purpose of precluding the king and his wise men from the excuse which unbelief might still suggest, viz. that they were produced by the powerful incantations of Moses and Aaron."<sup>3</sup>

#### **Flies (the fourth plague) 8:20-32**

Moses announced this plague to Pharaoh like the first, in the morning beside the Nile River (v. 20; cf. 7:15). Again, creatures that man was mandated to control brought destruction and misery to the land, as well as to the Egyptians, by the hand of Yahweh.

These insects were very annoying, even more bothersome than the gnats.

---

<sup>1</sup>Davis, p. 103.

<sup>2</sup>A. Wolinski, "Egyptian Masks: the Priest and His Role," *Archaeology* 40:1 (January-February 1987):22-29.

<sup>3</sup>Keil and Delitzsch, 1:484.

"When enraged, they fasten themselves upon the human body, especially upon the edges of the eyelids. ... [they] not only tortured, 'devoured' (Ps. 78:45) the men, and disfigured them by the swellings produced by their sting, but also killed the plants in which they deposited their eggs ..."1

"The blood-sucking gadfly or dogfly was something to be abhorred and may in part have been responsible for the great deal of blind men in the land. ... It might also be noted that the Ichneuman fly, which deposits its eggs on other living things upon which its larvae can feed, was regarded as the manifestation of the god Uatchit."2

God demonstrated His sovereignty over space, as well as nature and time, by keeping the flies out of "Goshen" and off the Israelites (v. 22). The exact location of Goshen is still unknown, but its general location seems to have been in either the eastern part of the delta region of Egypt (cf. Gen. 46:28-29, 33-34; 47:1-6, 11)<sup>3</sup> or the western part.<sup>4</sup> Some of the commentators have assumed that the first three plagues did not afflict the Israelites either, though the text does not say so explicitly (cf. 7:19; 8:2, 16, 17). God miraculously distinguished between the two groups of people, primarily to emphasize to Pharaoh that Israel's God was the author of the plagues, and that He was sovereign over the whole land of Egypt (v. 23).

For the first time, Pharaoh gave permission for the Israelites to sacrifice to Yahweh (v. 25), but he would not allow them to leave Egypt. Pharaoh admitted that Yahweh was specifically the God of Israel ("your God"), but he did not admit that he had an obligation to obey Him.<sup>5</sup>

The Egyptians regarded the animals the Israelites would have sacrificed as holy (set apart as special), because they were manifestations of their gods. Consequently the sacrifices would have been an abomination to them (v. 26).<sup>6</sup>

---

<sup>1</sup>Ibid., 1:484-85.

<sup>2</sup>Davis, p. 106.

<sup>3</sup>Durham, p. 114.

<sup>4</sup>Wood, *A Survey ...*, p. 112.

<sup>5</sup>Meyer, p. 121.

<sup>6</sup>Cassuto, pp. 108-09. Cf. Cole, p. 95.



"... we know from excavations that this Pharaoh, Amenhotep II, worshipped bulls."<sup>1</sup>

The "abomination" that the Israelites' sacrifice would have constituted to the Egyptians, may have also consisted in the method by which the Israelites would have sacrificed these animals. The Egyptians themselves practiced animal sacrifices, but they had rigorous procedures for cleansing their sacrificial animals before they killed them, which the Israelites would not have observed.<sup>2</sup>

Pharaoh agreed to let the Israelites leave Egypt, to sacrifice temporarily in the wilderness, after Moses reminded him of the problems involved in sacrificing in Egypt (v. 28). Yet they were not to go very far from Goshen. Again, Pharaoh asked Moses to pray that his God would remove the plague ("Plead for me," v. 28; cf. 8:9). Even though the LORD graciously removed the swarms of flies from Pharaoh, the king hardened his heart again and changed his mind (vv. 31-32).

"What is new in this fourth of the mighty acts, apart from the nature of the miracle itself, is the separation of the land of Goshen from the effects of miracle (there has been no mention of Goshen's fate in the earlier accounts), the negotiations between Pharaoh and Moses, with each of them setting conditions, and the allusion to the antipathy of the Egyptians to Israel worship [*sic*] (or to Israelite ways, and to Israelites in general)."<sup>3</sup>

### **Murrain (the fifth plague) 9:1-7**

This plague, apparently some kind of disease like *anthrax*, was more severe than the preceding ones, in that it affected the personal property of the Egyptians for the first time. "Murrain" is a general name for infectious diseases that affect cattle or other animals.

"The whole creation is bound together by invisible cords. None can sin or suffer alone. No man liveth or dieth to himself. Our

---

<sup>1</sup>Gispen, p. 94.

<sup>2</sup>See Ernst Hengstenberg, *Egypt and the Books of Moses*, p. 114; J. Philip Hyatt, *Exodus*, p. 112.

<sup>3</sup>Durham, p. 115.

sins send their vibrations through creation, and infect the very beasts."<sup>1</sup>

All the other plagues had caused the Egyptians irritation or pain to their bodies, but now God began to reduce their wealth. This is also the first plague that caused death.

"The religious implications of this plague are most interesting and instructive. A large number of bulls and cows were considered sacred in Egypt. In the central area of the Delta, four provinces chose as their emblems various types of bulls and cows. A necropolis of sacred bulls was discovered near Memphis which place was known for its worship of both Ptah and a sacred Apis bull. The Apis bull was considered the sacred animal of the God Ptah; therefore, the associated worship at the site of Memphis is readily understood. There was at any one time only one sacred Apis bull. As soon as it died another was chosen to take its place, an event that attracted a great deal of attention in the area of Memphis.<sup>2</sup> The sacred bull was supposed to have been recognized by twenty-eight distinctive marks that identified him as deity and indicated that he was the object of worship.<sup>3</sup>

"Another deity whose worship would have been affected by the impact of this plague was Hathor, the goddess of love, beauty and joy represented by the cow. The worship of this deity was centered mainly in the city of Denderah although its popularity is witnessed by representations both in upper and lower Egypt. This goddess is often depicted as a cow suckling the king giving him divine nourishment. In upper Egypt the goddess appears as a woman with the head of a cow. In another town—Hathor was a woman, but her head was adorned with two horns of a cow with a sun disc between them. Another deity associated with the effects of the plague

---

<sup>1</sup>Meyer, p. 122.

<sup>2</sup>Montet, p. 172.

<sup>3</sup>Author not identified, *Archaeology and the Bible*, p. 181, cited by Davis.

would be Mnevis, a sacred bull venerated at Heliopolis and associated with the god Re."<sup>1</sup>

"Amenhotep II [the probable Pharaoh of the plagues] surpassed all his predecessors in his fanatical devotion to the worship of animals, and especially of the bull. In 1906 a statue made of sandstone was excavated representing a cow and Amenhotep II leaning his head under its head; he is also depicted kneeling under a cow, drinking its divine milk. He is thus seen as child and slave of the cow goddess. What a threat this must have been to him!"<sup>2</sup>

The expression "all the livestock of Egypt" (v. 6) evidently refers to all the Egyptians' farm animals in the fields (v. 3). Some cattle survived this plague (cf. vv. 19, 20, 22). Another view is that this is hyperbole (overstatement for the sake of emphasis).

A new element in this fifth report is the notice that Pharaoh sent messengers to Goshen to check on the predicted exclusion of the Israelites' livestock from the epidemic (v. 7).

### **Boils (the sixth plague) 9:8-12**

God commanded Moses to take up in his hands the "soot from a kiln," (cf. NRSV, ESV, NEB; or "ashes from a furnace," NKJV, cf. AV; or "soot from a furnace," NIV, TNIV; or "furnace soot," HCSB; or "ashes from a stove," CEV; v. 8). The soot and the kiln were both significant: First, the soot was black, and symbolized the blackness of skin in the disease that followed, linking the cause with the effect. Second, the kiln was probably one of the furnaces in which the Israelites baked bricks for Pharaoh as his slaves. These furnaces became a symbol of Israel's slavery (cf. Deut. 4:20; 1 Kings 8:51; Jer. 11:4). In this plague, God converted the suffering of the Israelites in the "furnace" of Egypt, so that the soot in the literal furnaces became a source of suffering to the Egyptians.

"The natural substratum of this plague is discovered by most commentators in the so-called Nile-blisters, which come out in innumerable little pimples upon the scarlet-coloured skin, and change in a short space of time into small, round, and thickly-

---

<sup>1</sup>Davis, pp. 113-115.

<sup>2</sup>Gispén, p. 96.

crowded blisters. This is called by the Egyptians *Hamm el Nil*, or the heat of the inundation. According to Dr. *Bilharz*, it is a rash, which occurs in summer, chiefly towards the close at the time of the overflowing of the Nile, and produces a burning and pricking sensation upon the skin; or, in *Seetzen's* words, 'it consists of small, red, and slightly rounded elevations in the skin, which give strong twitches and slight stinging sensations, resembling those of scarlet fever' (p. 209). The cause of this eruption, which occurs only in men and not in animals, has not been determined; some attributing it to the water, and others to the heat."<sup>1</sup>

"This plague, like previous ones, most assuredly had theological implications for the Egyptians. While it did not bring death, it was serious and painful enough to cause many to seek relief from many of the Egyptian deities charged with the responsibility of healing. Serapis was one such deity. One is also reminded of Imhotep, the god of medicine and the guardian of healing sciences. The inability of these gods to act in behalf of the Egyptian surely must have led to deep despair and frustration. Magicians, priests, princes, and commoners were all equally affected by the pain of this judgment, a reminder that the God of the Hebrews was a sovereign God and superior to all man-made idols."<sup>2</sup>

"In this plague account we learn that the magicians were still hard at work opposing the signs of Moses [v. 11]. A new twist, however, is put on their work here. Their problem now is not that they cannot duplicate the sign—something which they would not likely have wanted to do; rather, they cannot 'stand before Moses because of the boils.' This is apparently intended to show that, like the earlier plagues, this plague did not affect the Israelites, represented here by Moses and Aaron. It also provides a graphic picture of the ultimate failure of the magicians to oppose the work of Moses and Aaron. The

---

<sup>1</sup>Keil and Delitzsch, 1:487.

<sup>2</sup>Davis, pp. 116-17.

magicians lay helpless in their sickbed before the work of Moses and Aaron."<sup>1</sup>

This is the first time we read that "the LORD hardened Pharaoh's heart" (v. 12). If a person continues to harden his own heart, God will then harden it further in judgment (cf. Rom. 1). This is also the first indication that the Egyptian learned "soothsayer priests" or "magicians"—the best educated and most skilled in their supposedly advanced system of higher knowledge and secret arts—could no longer resist Moses and his God. They could not even "stand before" Moses and Aaron now (v. 11). This plague may have been the first one that caused the Egyptians to fear for their lives.

"The lesson here is that when one ignores the prompting of the Lord time and time again (see 7:13, 22; 8:15, 19, 32; 9:7), the Lord will confirm that resistance and make belief impossible."<sup>2</sup>

## **6. The seventh, eighth, and ninth plagues 9:13—10:29**

Moses announced the purpose of the following plagues to Pharaoh "early in the morning" (v. 13; cf. 7:15; 8:20). This purpose was twofold: that Pharaoh personally might know God's power (v. 14), and that the whole world might know it (v. 16; cf. Rom. 9:17).

### **Hail (the seventh plague) 9:13-35**

God sent the worst hailstorm Egypt had ever experienced (vv. 18, 24), and accompanied it with "thunder," "hail," and "fire" (lightning? vv. 23, 34).

"The recurring thunderclaps ..., the lightning darting back and forth ..., and the severity of the storm ... all suggest the advent of Yahweh in theophany ... and thus the Presence of Yahweh in a more dramatic and intense coming than anywhere in the mighty-act sequence to this point."<sup>3</sup>

"The fact that God was judging Pharaoh does not mean He was unmerciful. The Lord could have destroyed Pharaoh and his

---

<sup>1</sup>Sailhamer, *The Pentateuch ...*, p. 256.

<sup>2</sup>Merrill, in *The Old ...*, p. 49. Cf. Heb. 6:6.

<sup>3</sup>Durham, p. 128. See Robert B. Chisholm Jr., "The Polemic against Baalism in Israel's Early History and Literature," *Bibliotheca Sacra* 151:603 (July-September 1994):271-74.

people in a moment (v. 15), but He did not. He could have brought each plague without warning, but in most cases He served notice (see 7:16). In anticipation of this plague, He warned the Egyptians to gather their livestock so they might be spared the hailstorm."<sup>1</sup>

Pharaoh's repentance was shallow, even though his words sounded sincere. He acknowledged only his mistake and unfairness ("I have sinned ... I and my people are the wicked ones," v. 27), but he did not repent of his arrogance against Yahweh and submit to His sovereignty. He did, however, acknowledge that Yahweh was "the righteous one" (v. 27). He is the first person in the Bible that verbalized that God is righteous.<sup>2</sup> Moses perceived Pharaoh's true attitude. The king had not yet believed that Yahweh was sovereign ("I know that you do not yet fear the LORD God," v. 30). Fearing Yahweh means bowing in submission to Him as sovereign over all the earth.

"What would the worshippers of Nut have thought when they looked skyward not to see the blessings of the sun and warmth, but the tragedy of storm and violence. Nut was the sky goddess. It was from her domain that this tragedy originated. One reflects upon the responsibilities of both Isis and Seth who also had responsibilities relating to agricultural crops. The black and burned fields of flax were a silent testimony to the impotence and incapability of wooden and stone deities."<sup>3</sup>

The Egyptians used "flax" (v. 31) to make linen cloth, which they preferred over wool in their clothing. The Egyptian priests in particular dressed in linen, though other Egyptians also wore linen garments. This plague was a special judgment on the priests, therefore. The Egyptians used "barley" (v. 31) to make beer, and as feed for their livestock, but the poorer people also ate it.<sup>4</sup> These two crops, flax and barley, are in bud in late January and early February in lower (northern) Egypt, which enables us to identify the time of year when this plague took place.<sup>5</sup>

---

<sup>1</sup> *The Nelson ...*, p. 114.

<sup>2</sup> J. Carl Laney, *God*, p. 89.

<sup>3</sup> Davis, p. 120.

<sup>4</sup> Kaiser, "Exodus," p. 363.

<sup>5</sup> See also Jamieson, et al., p. 61.

"As in the following plague (locusts), mention is made of the effects of the plague on vegetation, and as such it seems to suggest another creation reversal. The world of plants is being undone here."<sup>1</sup>

### **Locusts (the eighth plague) 10:1-20**

Moses explained another purpose of God in sending further plagues, in this context: namely, so the Israelites in future generations would believe in Yahweh's sovereignty (v. 2). The phrase "that you (or they) may know that I am the LORD" occurs many times in the Old Testament. It means that people will come to acknowledge God for who He is and respond appropriately to Him.

"Those that will not humble themselves God will humble [v. 3]."<sup>2</sup>

Locusts were and still are a menace in Egypt, as well as in many other countries of the world. The wind drove them from the wetter areas to the whole land of Egypt—excluding Goshen—where they multiplied. They consumed the remaining half of the crops and trees left by the hail.<sup>3</sup> Among their other gods, the Egyptians prayed to one manifested as a locust, who, they believed, would preserve them from attacks by this devastating insect.<sup>4</sup>

Pharaoh's permission for the Israelites to leave Egypt to worship God, brought on by the urging of his counselors, was conditional: he permitted "only the men" to go (v. 11). Egyptian females worshipped with their husbands, so, to be fair, Pharaoh could have permitted both men and women to worship Yahweh.

Pharaoh offered Moses three compromises, which the world still offers Christians. First, he suggested that the Israelites stay in Egypt (8:25). He said, in effect: You can be who you are, but live as a part of your larger culture; do not be distinctive. Second, he permitted them to leave Egypt, but not to go far from it (8:28). He allowed them to separate from their culture, but not drastically. Third, he gave permission for the males to

---

<sup>1</sup>Enns, p. 222.

<sup>2</sup>Henry, p. 81.

<sup>3</sup>On the tremendously destructive power of locusts, see Davis, pp. 120-22.

<sup>4</sup>See Montet, pp. 39, 169.

leave, but their women and children had to remain in Egypt (10:8-11). Even godly parents are sometimes inclined to desire prosperity and worldly position for their children.

"Wanting the 'best' of the world for their children is the most subtle temptation that can come to Christian parents."<sup>1</sup>

A fourth compromise was yet to come (v. 24).

Pharaoh's servants seem to have been ready and willing to acknowledge Yahweh as a god ("the LORD their God," v. 7), but for Pharaoh, this conflict had greater significance. It was a test of sovereignty. The advice of Pharaoh's servants reflects their extreme distress (v. 7). It also fulfilled God's prediction that the Egyptians would acknowledge His sovereignty (7:5; cf. 8:19; 9:20; 12:33). Pharaoh's magicians had failed him (8:19), and now his servants turned against him (v. 7).

"The king who ... has a direct knowledge of the predestined order of the universe, cannot consult mere mortals. His decisions are represented as spontaneous creative acts motivated by considerations which are beyond human comprehension, although he may graciously disclose some of them."<sup>2</sup>

Joseph had previously delivered the Egyptians *from* starvation, but now Moses brought them *to* starvation. Both effects were the result of official Egyptian policy toward Abraham's descendants (cf. Gen. 12:3).

Pharaoh's confession of sin and his request for forgiveness were also most unusual, and seem even more genuine than his previous one (v. 16; cf. 9:27).

"The Egyptian viewed his misdeeds not as sins, but as aberrations. They would bring him unhappiness because they disturbed his harmonious integration with the existing world; they might even be explicitly disapproved by one or another of the gods, but these were always ready to welcome his better insight. ... It is especially significant that the Egyptians never showed any trace of feeling unworthy of the divine mercy. For

---

<sup>1</sup>McGee, 1:232.

<sup>2</sup>Frankfort, p. 56.



he who errs is not a sinner but a fool, and his conversion to a better way of life does not require repentance but a better understanding."<sup>1</sup>

"... the picture of a halting, confused Pharaoh plays well here at the conclusion of the plague narratives. It shows that Moses and Aaron were beginning to get on his nerves."<sup>2</sup>

The locusts perished in the Red Sea, as did the Egyptian soldiers later (14:28). The "Red Sea" (v. 19) is the present Red Sea that lies to the east and south of the delta region. Some students of Exodus have mistakenly called it the Sea of Reeds. This opinion is due to the large quantity of papyrus reeds and seaweeds that, some scholars have claimed, grew on its banks and floated on its waters. However, these particular "reeds" do not grow in salt water.<sup>3</sup>

### Darkness (the ninth plague) 10:21-29

Since the other plagues to this point seem to have been natural phenomena heightened in their intensity and controlled in their timing, many commentators interpret this one as such too. The most common explanation for the darkness that lasted "three days" (v. 22), and which affected the Egyptians, but not the Israelites ("all the sons of Israel had light," v. 23), is that it resulted from a dust storm.

A wind "... which generally blows in Egypt before and after the vernal equinox and lasts two or three days, usually rises very suddenly, and fills the air with such a quantity of fine dust and coarse sand, that the sun loses its brightness, the sky is covered with a dense veil, and it becomes ... dark ..."<sup>4</sup>

"In the light of Egyptian theology and practice, this [ninth] plague was very significant. To a large degree it struck at the very heart of Egyptian worship and humbled one of Egypt's greatest gods. The sun god Re was considered one of the great blessings in the land of Egypt. His faithfulness in providing the

---

<sup>1</sup>Ibid., p. 73.

<sup>2</sup>Sailhamer, *The Pentateuch ...*, pp. 256-57.

<sup>3</sup>See Bernard F. Batto, "Red Sea or Reed Sea?" *Biblical Archaeology Review* 10:4 (July-August 1984):57-63; and my note on 14:2.

<sup>4</sup>Keil and Delitzsch, 1:498.

warmth and light of sun day after day without fail caused them to express great joy over the faithfulness of this deity. The attitude of the Egyptians regarding the sun is perhaps best expressed in what has been called 'a universalist hymn to the sun' translated by John Wilson.

"Hail to thee, beautiful Re of every day, who rises at dawn without ceasing, Khepri wearying (himself) with labor! Thy rays are in (one's) face, without one knowing it. Fine gold is not like the radiance of thee. Thou who has constructed thyself, thou didst fashion thy body, a shaper who was (himself) not shaped; unique in his nature, passing eternity, the distant one, under whose guidance are millions of ways, just as thy radiance is like the radiance of heaven and thy color glistens more than its surface.'<sup>1</sup>

"The faithful warmth and provision of the sun was something fully enjoyed by both the Egyptian statesman and the laborer who worked in the fields. They praised the sun because 'thou presentest thyself daily at dawn. Steadfast is thy sailing which carries thy majesty.'<sup>2</sup>

"Of particular significance with respect to this plague was the prestige of the god Amun-Re, the chief deity of Thebes and a sun god. In the New Kingdom period [when the plagues took place] this god was the Egyptian national god, part of a very important triad of deities including Amun-Re, his wife Mut, and their son Khons. Amun-Re was commonly represented by sacred animals such as the ram and the goose. A number of other deities were associated with the sun, sky, and moon; for example Aten was the deified sun disc. This god was proclaimed to be the only god by [Pharaoh] Akhenaten with emphasis on a special cult centered at Amarna. Atum was also another important god in lower Egypt whose worship was centered mainly at Heliopolis. He was the god of the setting sun and was usually depicted in human form. Sacred animals

---

<sup>1</sup>Pritchard, pp. 367-68.

<sup>2</sup>Ibid., p. 368.

associated with this god were the snake and the lion. The god Khepre who often appeared in the shape of the beetle (*Scarabeus sacer*) was a form of the sun god Re. Another very important sun god was Horus often symbolized by a winged sun disc. He was considered to be the son of Osiris and Isis but also the son of Re and the brother of Seth. Harakhte, another form of Horus and identified with the sun, was venerated mainly at Heliopolis and was represented by the hawk.

"Among the deities affected by this tragic darkness was Hathor a sky goddess and likewise the goddess of love and joy. Hathor was the tutelary deity of the Theban necropolis. She was venerated particularly at Dendera and depicted with cow horns or was a human figure which was cow-headed. The sky goddess Nut would also have been involved in the humiliation of this plague. What of the prestige of Thoth, a moon god of Hermopolis? He was also the god of writing and of the computation of time.

"This list could be greatly extended involving a number of other deities associated with the sun, stars, and light but the above are sufficient to indicate the tremendous importance of the sun and sunlight to the Egyptians. ... One wonders what the prestige of Pharaoh must have been at this point. Among the divine attributes of Pharaoh was the fact that he was in fact a representation of Re '... by whose beams one sees, he is one who illuminates the two lands [Upper and Lower Egypt] more than the sun disc.'"<sup>1</sup>

"Darkness is a 'chaos' word [as well as a symbol of death; cf. 1 Sam. 2:9; Job 15:30; 17:13; 18:18; Ps. 88:12, 18; 143:3]. It was the first thing God brought under control by introducing light in Genesis 1:3. A reintroduction of darkness brings creation back to its chaotic beginnings, which is a signal to the Egyptians of what awaits them at the sea."<sup>2</sup>

Pharaoh still did not submit to Yahweh's sovereign demands (v. 24), and this time he even threatened Moses ("Be careful, do not see my face again,

---

<sup>1</sup>Davis, pp. 125-28. His last quotation is from Pritchard, p. 431.

<sup>2</sup>Enns, p. 229.

for on the day you see my face, you shall die!" v. 28). So a tenth plague followed. By excluding Moses from his presence, Pharaoh was effectively excluding God from his presence.

Pharaoh's fourth compromise was that the families of the Israelites could leave Egypt, but they had to leave their flocks and herds behind (v. 24). Many a redeemed believer has escaped the enslavement of the world, but still has his treasure in the world (cf. Matt. 6:19-20). Had Moses accepted this compromise, many of the Israelites would have wanted to return to Egypt to claim their possessions there.

"For the first time, Yahweh moves to make Pharaoh obstinate *during* the negotiations. Heretofore he has made Pharaoh stubborn *after* he has agreed to Moses' demands, after Yahweh's mighty action has ceased and before Moses can leave with the sons of Israel."<sup>1</sup>

"It is a sad farewell when God, in the persons of his servants, refuses anymore to see the face of the wicked."<sup>2</sup>

The world had begun in total darkness (Gen. 1:2), and now Egypt had returned to that chaotic state.<sup>3</sup> Richard Patterson argued convincingly that the origin of much of the apocalyptic imagery later in the Old Testament derives from this Exodus event (the darkness plague).<sup>4</sup>

## 7. The proclamation of the tenth plague ch. 11

Chapter 11 is really only the first part of the section of Exodus that deals with the tenth plague. The whole section runs from 11:1 through 13:16.

"... the slaying of the first-born is both the culmination of the plague narrative and the beginning of the passover tradition.

---

<sup>1</sup>Durham, p. 143.

<sup>2</sup>George Bush, *Notes on Exodus*, 1:30.

<sup>3</sup>Sailhamer, *The Pentateuch ...*, p. 257.

<sup>4</sup>Richard D. Patterson, "Wonders in the Heavens and on the Earth: Apocalyptic Imagery in the Old Testament," *Journal of the Evangelical Theological Society* 43:3 (September 2000):385-403.

Chapter 11 as a literary unit, therefore, points both backward and forward."<sup>1</sup>

Evidently Moses made his announcement of the tenth plague to Pharaoh (vv. 4-8) before leaving his presence, following the ninth plague (cf. 10:29). Thus this chapter unfolds the narrative in logical rather than chronological order. Verses 1 and 2 give the foundation for the announcement. Chronologically verses 1-3 point back to 3:19-22.

Whereas Moses and Aaron had been the mediators through whom God had sent the first nine plagues, this last one came directly from God. The announcement by Moses was a message from God: "This is what the LORD says ..." (v. 4).

11:1-3      The NIV and TNIV translated the first part of verse 1: "Now the LORD *had said* to Moses," referring back to 4:21-23. This is legitimate, since the Hebrew language has no pluperfect tense. Most English translations have this phrase: "Now the LORD *said* to Moses." In either case, the following statement (vv. 1b-2) restates what God had previously told Moses.

The Israelites asked the Egyptians to give them articles of silver and gold, not to lend them with a view to getting them back (v. 2).<sup>2</sup> The Israelites, from this time on until they left Egypt, received many such gifts from the Egyptians—enough to build the tabernacle, its furniture, furnishings, and utensils, as well as the priests' garments (cf. 12:35-36). This reflects the respect and fear the Israelites enjoyed in Egypt following these plagues. These attitudes are seen in the Egyptians' respect for Moses as well (v. 3).

"The Egyptians thus are 'picked clean' (3:22 and 12:36) by Israel as a result of yet another action by Yahweh in behalf of his people, demonstrating the power of his Presence."<sup>3</sup>

---

<sup>1</sup>Childs, p. 161.

<sup>2</sup>For a history of the interpretation of this controversial statement, see Yehuda T. Radday, "The Spoils of Egypt," *Annual of the Swedish Theological Institute* 12 (1983):127-47.

<sup>3</sup>Durham, p. 148.

11:4-8 The firstborn sons of Egypt (both man and beast)—who apparently were not fathers themselves—would die (v. 5). This limitation of the firstborn males is a deduction supported by the following facts: (1) Firstborn sons were symbolic of a nation's strength and vigor (cf. Gen. 49:3). (2) Firstborn sons were also those through whom the family line descended. (3) Sons old enough to be fathers, who had themselves fathered sons, were members of the older generation, but the younger generation was the focus of this plague. It was the male *children* of the Israelites that Pharaoh had killed previously (1:15-22).

"Moses warned Pharaoh that the way he treated God's firstborn [Israel] would determine how God treated Egypt's firstborn (Ex. 4:22-23). Pharaoh had tried to kill the Jewish male babies, and his officers had brutally mistreated the Jewish slaves, so in slaying the firstborn, the Lord was simply paying Pharaoh back with his own currency."<sup>1</sup>

Even the firstborn of the cattle would die, probably because the Egyptians' cattle were object of their veneration.<sup>2</sup>

When God later claimed the tribe of Levi in place of Israel's firstborn sons, whom He spared in this plague (Num. 3:12-13; cf. Exod. 22:29; 34:20), He chose only the males—as He chose only the male Egyptians in this plague.

"In common with the rest of the ancient Near East, the Hebrews believed that the deity, as lord of the manor, was entitled to the *first share* of all produce. The *firstfruits* of plants and the *firstborn* of animals and man were his. The Lord demonstrated that he gave Egypt its life and owned it by taking its firstborn."<sup>3</sup>

---

<sup>1</sup>Wiersbe, p. 197.

<sup>2</sup>Sarna, *Exodus*, p. 52.

<sup>3</sup>Bruce K. Waltke, "Cain and His Offering," *Westminster Theological Journal* 48:2 (Fall 1986):368.

We, too, owe God the first fruits of our labors, because He is the source of all life and fruitfulness.

Some critics of the Bible have challenged God's justice in putting to death so many "innocent" children. Looked at one way, whatever God does is right because He is God. Looked at another way, God—as the Giver and Sustainer of Life—is righteous in ending the life of any creature, at any time, because life belongs to Him. He can take it as well as give it at will. Furthermore, the fact that humans are all sinners, and sin results in death (carries the death sentence), means that God is just in requiring the punishment for any individual's sin at any time. We do not have any claim on God's grace. God graciously did not kill *all* the Egyptians.

When Pharaoh killed the Israelite children, he was really killing the children of Yahweh, since God said, "Israel is My son, My firstborn" (4:22).

Moses' hot anger reflected God's wrath against Pharaoh for his stubborn rebellion (v. 8).

"To be in the presence of evil and not be angry is a dreadful spiritual and moral malady."<sup>1</sup>

11:9-10

"These two verses are considered by many commentators as redundant or misplaced. But they can easily be explained as a summary and epilogue of the Section of the Plagues.

"In the following section not only the course of events will change, but also the background and the *dramatis personae*. Till now the central theme was the negotiations conducted by Moses and Aaron on the one hand, and Pharaoh and his servants on the other, in Pharaoh's palace or its environs. But henceforth the principal hero of the drama will be the people of Israel in its totality, and the perspective will be enlarged. Moses and Aaron will no longer be sent to Pharaoh but to the

---

<sup>1</sup>Kaiser, "Exodus," p. 370.

Israelites, in order to prepare them for the exodus and to implement it; nor will they be enjoined again to perform acts for the purpose of bringing the plagues, for the last plague will take place of its own accord, through the instrumentality of the angel of the Lord. Since the episode about to be narrated represents a new theme, and one, moreover, of fundamental importance, it is desirable [*sic*] that before reading this account we should look back for a moment, and review generally the events that have taken place thus far, as well as the situation obtaining at the conclusion of those events. This review is provided for us in the verses under consideration."<sup>1</sup>

The theological lesson that Pharaoh and the Egyptians were to learn from this plague, was that Yahweh would destroy the males that the Egyptians' gods supposedly procreated, namely, all their firstborn sons. Pharaoh was a supposed "god," and so was his firstborn son, who would succeed him. The Egyptians attributed the power to procreate to various gods. Fertility was a power for which the Egyptians, as well as all ancient peoples, depended on their gods. By killing the firstborn, Yahweh was demonstrating His sovereignty once again. However, this plague had more far-reaching consequences, and was therefore more significant than all the previous plagues combined.

"Possibly no land in antiquity was more obsessed with death than Egypt. The real power of the priesthood lay in its alleged ability to guarantee the dead a safe passage to the 'Western World' under the benign rule of Osiris. This terrible visitation which defied and defies all rational explanation, showed that Yahweh was not only lord of the forces of nature, but also of life and death."<sup>2</sup>

"... it is by means of the account of the last plague that the author is able to introduce into the Exodus narrative in a clear and precise way the notion of redemption from sin and death.

---

<sup>1</sup>Cassuto, pp. 134-35.

<sup>2</sup>Ellison, p. 60.



The idea of salvation from slavery and deliverance from Egypt is manifest throughout the early chapters of Exodus. The idea of redemption and salvation from death, however, is the particular contribution of the last plague, especially as the last plague is worked into the narrative by the author. ...

"By means of the last plague, then, the writer is able to bring the Exodus narratives into the larger framework of the whole Pentateuch and particularly that of the early chapters of Genesis. In the midst of the judgment of death, God provided a way of salvation for the promised seed (Ge 3:15). Like Enoch (5:22-24), Noah (6:9), and Lot (19:16-19), those who walk in God's way will be saved from death and destruction."<sup>1</sup>

This tenth plague brought Yahweh's concentrated education of both the Egyptians and the Israelites to a climactic conclusion.

"In short, therefore, what were the essential purposes of these ten plagues? First of all, they were certainly designed to free the people of God. Second, they were a punishment upon Egypt for her portion in the long oppression of the Hebrews [cf. Gen. 15:13]. Third, they were designed to demonstrate the foolishness of idolatry. They were a supreme example both for the Egyptians and for Israel. It was by these that Jehovah revealed His uniqueness in a way that had never before been revealed (6:3; cf. 10:2). Finally, the plagues clearly demonstrated the awesome, sovereign power of God. In the Book of Genesis, God is described as the Creator of the heavens and the earth and all the laws of nature. In the Book of Exodus the exercise of that creative power is revealed as it leads to the accomplishment of divine goals. God's sovereignty is not only exercised over the forces of nature, but is also revealed against evil nations and their rulers."<sup>2</sup>

"They [the plagues] touched every phase of nature: mineral, animal, vegetable, human. They affected persons and property, and included all, from the highest to the lowest."<sup>3</sup>

---

<sup>1</sup>Sailhamer, *The Pentateuch ...*, p. 258.

<sup>2</sup>Davis, pp. 151-52.

<sup>3</sup>W. H. Griffith Thomas, *Through the Pentateuch Chapter by Chapter*, p. 87.

"A few clues exist for determining the length of time between the first and last plagues. While no certain conclusion can be reached, the probable time is just under six months."<sup>1</sup>

These plagues came upon Egypt when this nation was at the apex of its imperial supremacy, most probably under Amenhotep II. Interestingly, several of the judgments in the Great Tribulation, especially the bowl judgments (Rev. 16), are similar to these plagues in Egypt. God will again do similar acts of judgment and demonstrate His sovereignty in the future, but on a worldwide scale.

### C. GOD'S REDEMPTION OF HIS PEOPLE 12:1—13:16

Scholars differ in their opinions as to when Israel actually became a nation. Many have made a strong case for commencing national existence with the institution of the Passover, which this section records.<sup>2</sup>

"... properly understood, the Exodus also is precisely the event and the moment that coincides with the historical expression of God's election of Israel. The choice of Israel as the special people of Yahweh occurred not at Sinai but in the land of Goshen. The Exodus was the elective event; Sinai was its covenant formalization."<sup>3</sup>

Other scholars regard the ratification ceremony, when the Israelites received and agreed to keep the Mosaic Covenant, as the historical beginning of the nation (24:4-8).<sup>4</sup>

God gave the Israelites a national calendar that set them apart from other nations (v. 2). They also received instructions for two national feasts that they were to perpetuate forever thereafter (vv. 14, 17, 24). Also, Moses revealed and explained, here, the event that resulted in their separation from Egypt (the tenth plague: the death of all Egypt's firstborn).

---

<sup>1</sup>Wood, *A Survey ...*, p. 126.

<sup>2</sup>E.g., Jamieson, et al., pp. 64-65; Edersheim, p. 209; Arno C. Gaebelin, *The Annotated Bible*, 1:1:135.; Kaiser, *Toward an ...*, p. 105.

<sup>3</sup>Eugene H. Merrill, "A Theology of the Pentateuch," in *A Biblical Theology of the Old Testament*, p. 31. Cf. Sailhamer, *The Pentateuch ...*, p. 259; Enns, p. 230.

<sup>4</sup>E.g., Wood, *A Survey ...*, p. 145.

## 1. The consecration of Israel as the covenant nation 12:1-28

"The account of the final proof of Yahweh's Presence in Egypt has been expanded by a series of instructions related to cultic [ritual worship] requirements designed to commemorate that proof and the freedom it purchased."<sup>1</sup>

### Directions for the Passover 12:1-14

The Jews called their first month, their "beginning of months," Abib (v. 2). After the Babylonian Captivity, they renamed it Nisan (Neh. 2:1; Esth. 3:7). It corresponds to our March-April. Abib means "ear-month," referring to the month when the grain was "in the ear."

"The reference to the Passover month as the 'lead month,' 'the first of the year's months' is best understood as a *double entendre*. On the one hand, the statement may be connected with an annual calendar, but on the other hand, it is surely an affirmation of the theological importance of Yahweh's Passover."<sup>2</sup>

"... the sense of the verse [v. 2] is: you are now beginning to count a new year, now the new year will bring you a change of destiny."<sup>3</sup>

The spring was an appropriate time for the Exodus because it symbolized new life and growth. Israel had two calendars: one religious, this one, and one civil (23:16). The civil year began exactly six months later in the fall. The Israelites used both calendars until the Babylonian Captivity. After that, they used only the civil calendar.<sup>4</sup>

"While in Egypt the Hebrews may have conformed to the solar year of 12 months, each of 30 days + 5 additional days, i.e. 365 days (Herodotus, ii. 4), but if so a change was made thereafter and the 'beginning of months' or first month of the

---

<sup>1</sup>Durham, p. 152.

<sup>2</sup>Ibid., p. 153.

<sup>3</sup>Cassuto, p. 137.

<sup>4</sup>See James F. Strange, "The Jewish Calendar," *Biblical Illustrator* 13:1 (Fall 1986):28-32. Also see Appendix 1 of these notes for a chart of the Hebrew calendar.

year was fixed in the spring (Ex. xii. 2; Dt. xvi. 1, 6). Thereafter the Hebrew year followed the West Semitic Calendar with a year of 12 lunar months (1 Ki. iv. 7; 1 Ch. xxvii. 1-15). It is not certain whether the commencement of the year in spring (Nisan) was for use only in the ritual, since there is some evidence for the year for civil purposes being sometimes reckoned from the autumn month of Tishri (see CHRONOLOGY OF THE OLD TESTAMENT)."<sup>1</sup>

"The Egyptians had early learned that the sun's year is approximately 365 days; they therefore added to the twelve [lunar] months of thirty days five extra days to form a year whose deviation from the true solar year would not be discovered for several generations. The Babylonians were content to retain the year of twelve months, intercalating a new month when it was observed that the seasons were out of order."<sup>2</sup>

"Hebrew months were alternately 30 and 29 days long. Their year, shorter than ours, had 354 days. Therefore, about every 3 years (7 times in 19 years) an extra 29-day month, Veadar, was added between Adar [February-March] and Nisan [March-April]."<sup>3</sup>

The Passover was a communal celebration. The Israelites were to observe it with their redeemed brethren, not alone (v. 4). They celebrated the corporate redemption of the nation corporately (cf. Luke 22:17-20; 1 Cor. 11:23-29). Meredith Kline argued that the proper translation of the Hebrew word *pasah* is really "hover over" rather than "pass over."<sup>4</sup>

Some critics of the Bible claim that Israel's Passover was merely an adaptation of a pagan agricultural festival, presumably Canaanite. This view has been refuted by archaeological discoveries.

---

<sup>1</sup> *The New Bible Dictionary*, s.v. "Calendar," by F. F. Bruce, pp. 176-79. See also Finegan, pp. 564-80, for more information about the Egyptian, Babylonian, and Israelite calendars.

<sup>2</sup> Olmstead, p. 6.

<sup>3</sup> *The Nelson ...*, p. 318.

<sup>4</sup> Meredith G. Kline, "The Feast of Cover-over," *Journal of the Evangelical Theological Society* 37:4 (December 1994):497-510.

"Every fresh publication of Canaanite mythological texts makes the gulf between the religions of Canaan and of Israel increasingly clear."<sup>1</sup>

Since the lamb chosen for the Passover meal was a substitute sacrifice, its required characteristics are significant (v. 5; cf. John 1:29; 1 Cor. 5:7; 1 Pet. 1:19).

"Freedom from blemish and injury not only befitted the sacredness of the purpose to which they were devoted, but was a symbol of the moral integrity of the person represented by the sacrifice. It was to be a male, as taking the place of the male first-born of Israel; and a year old, because it was not till then that it reached the full, fresh vigour of its life."<sup>2</sup>

"During the days preceding Passover, our Lord's enemies questioned Him repeatedly, waiting for Him to say something they could attack. During His various trials and interrogations, Jesus was repeatedly questioned, and He passed every test. Jesus knew no sin (2 Cor. 5:21), did no sin (1 Peter 2:22), and in Him there was not sin (1 John 3:5). He's the perfect Lamb of God."<sup>3</sup>

Some of the ancient rabbis taught that God wanted the Jews to sacrifice the Passover lamb exactly at sunset, because of the instructions in verse 6 and Deuteronomy 16:6. However, "at twilight" literally means "between the two evenings." The more widely held Jewish view was that the "first evening" began right after noon, and the "second evening" began the same day when the sun set.<sup>4</sup> In Josephus' day, which was also Jesus' day, the Jews slew the Passover lamb in mid-afternoon.<sup>5</sup> The Lord Jesus Christ died during this time (i.e., about 3:00 p.m., Matt. 27:45-50; Mark 15:34-37; Luke 23:44-46; 1 Cor. 5:7).

The sprinkling of the blood of the lamb on the sides and the top ("doorposts and lintel," v. 7) of the doorway into the house was a sign. It symbolized,

---

<sup>1</sup>William F. Albright, "Recent Progress in North-Canaanite Research," *Bulletin of the American Schools of Oriental Research*, 70 (April 1938):24. Quoted by Free, p. 97.

<sup>2</sup>Keil and Delitzsch, 2:10.

<sup>3</sup>Wiersbe, p. 198.

<sup>4</sup>Gispén, p. 117.

<sup>5</sup>Josephus, *Antiquities of ...*, 14:4:3.

to the passing death angel, that God's redemptive protection applied to the household. And it symbolized, to the occupants, that they and their firstborn sons must be "passed over" because of the blood (v. 13). The door (doorway, the doorposts and lintel) represented the house (cf. 20:10; Deut. 5:14; 12:17; et al.). The smearing of the blood on the doorposts and lintel with hyssop was an act of expiation (cleansing; cf. Lev. 14:49-53; Num. 19:18-19). This act, in effect, consecrated the houses of the Israelites as altars. They had no other altars in Egypt.

The Israelites were not to apply the blood to the other member of the doorframe, the threshold, because someone might tread on the blood there. The symbolic value of the blood would have made this action (treading on the blood) inappropriate. The entire ritual signified to the Jews that the shed blood of a sinless, divinely appointed substitute cleansed their sins and resulted in their being set apart (sanctified) to God. The application of the blood, as directed, was a demonstration of the Israelites' faith in God's promise that He would pass over them (v. 13; cf. Heb. 11:28).

The method of preparing and eating the lamb was also significant (vv. 8-11). God directed that they roast it in the manner common to nomads, rather than eating it raw, as many of their contemporary pagans ate their sacrificial meat (cf. 1 Sam. 2:14-15). They were not to boil the lamb either (v. 9). Roasting enabled the host to place the lamb on the table undivided and unchanged in its essential structure and appearance. This method of cooking would have strengthened the impression of the substitute nature of the lamb: It looked like, and was intended to signify, an entire animal, rather than just meat.

The unleavened bread was bread that had not risen, because it had no yeast in it (cf. 12:34). The bitter herbs—perhaps endive, chicory, and/or other herbs native to Egypt—would later recall to the Israelites who ate them, the bitter experiences of life in Egypt. However, the sweetness (savory flavor) of the lamb overpowered the bitterness of the herbs. The Israelites were not to eat any uneaten parts of this meal again as leftovers (v. 10). It was a special sacrificial meal, not just another dinner. Moreover, they were to eat it in haste (v. 11), as a memorial of the events of the night when they first ate it—the night when God provided deliverance for

His people.<sup>1</sup> Evidently the Israelites normally went barefoot in their homes, and would lay their staffs aside when they entered their dwellings. God told them to eat the Passover with their sandals on their feet and their staff in their hand (v. 11). This reinforced the sense of urgency with which they had to eat the meal.

"Those consuming the meat were not to be in the relaxed dress of home, but in traveling attire; not at ease around a table, but with walking-stick in hand; not in calm security, but in haste, with anxiety."<sup>2</sup>

In slaying the king's son, and many of the firstborn animals, God humiliated the corresponding gods of Egypt that these living beings represented (v. 12). This was the final proof, in the plagues, of Yahweh's sovereignty.<sup>3</sup> It was apparently the LORD Himself who went through the land, killing the Egyptians and their cattle, not one of His angels (vv. 12-13).

"The firstborn of Pharaoh was not only his successor to the throne, but by the act of the gods was a specially born son having divine property. Gods associated with the birth of children would certainly have been involved in a plague of this nature. These included Min, the god of procreation and reproduction, along with Isis who was the symbol of fecundity or the power to produce offspring. Since Hathor was not only a goddess of love but one of seven deities who attended the birth of children, she too would be implicated in the disaster of this plague. From excavations we already have learned of the tremendous importance of the Apis bull, a firstborn animal and other animals of like designation would have had a tremendous theological impact on temple attendants as well as commoners who were capable of witnessing this tragic event. The death cry which was heard throughout Egypt was not only a wail that bemoaned the loss of a son or precious animals, but also the

---

<sup>1</sup>For an explanation of the history and modern observance of the Passover by Jews, the Seder, or "order of service," see Youngblood, pp. 61-64. For an account of a Seder observance held in Dallas, Texas, on April 2, 1988, see Robert Andrew Barlow, "The Passover Seder," *Exegesis and Exposition* 3:1 (Fall 1988):63-68.

<sup>2</sup>Durham, p. 154.

<sup>3</sup>See Bramer, pp. 93-94.

incapability of the many gods of Egypt to respond and protect them from such tragedy."<sup>1</sup>

Egyptian religion and culture valued sameness and continuity very highly. The Egyptians even minimized the individual differences between the Pharaohs.

"The death of a king was, in a manner characteristic of the Egyptians, glossed over in so far as it meant a change."<sup>2</sup>

The Egyptians had to acknowledge the death of Pharaoh's son, however, as an event that Yahweh had brought to pass.

Note that God said that when *He* saw the blood He would pass over the Jews (v. 13). He did not say when *they* saw it. The ground of their security was propitiation (God's satisfaction with the blood-sacrifice of the lamb). The blood satisfied God. Therefore the Israelites could rest. The reason Christians can have peace with God is that Jesus Christ's blood satisfied God. Many Christians have no peace because the blood of the Lamb of God does not satisfy them, or they doubt, because of a guilty conscience, that the blood has been applied in their case. They think something more has to supplement His work (i.e., human good works). However, God says the blood of the Sacrifice He provided is enough to satisfy Him (cf. 1 John 2:1-2).

The New Testament identifies the Passover lamb as a type of the Person and work of Jesus Christ, God's "Lamb." At the beginning of Jesus' public ministry, John the Baptist announced that Jesus was "the Lamb of God who takes away the sin of the world" (John 1:29). Paul wrote: "Christ our Passover ... has been sacrificed" (1 Cor. 5:7). Peter also identified Jesus as "a lamb unblemished and spotless" (1 Pet. 1:19).

The Passover anticipated the death of Christ in at least seven particulars: (1) The Passover lamb had to be without blemish (v. 5), and Jesus was without sin. (2) The Passover lamb had to be a male (v. 5), and Jesus was a male. (3) The Passover lamb had to be young ("a year old," v. 5), and Jesus was a young man. (4) The Passover lamb had to be examined over a period of four days from its selection to its killing (v. 6), and Jesus lived a meticulously examined life. (5) The Passover lamb had to be slain in public

---

<sup>1</sup>Davis, p. 141.

<sup>2</sup>Frankfort, p. 102.



(v. 6), and Jesus died in public. (6) The blood of the Passover lamb on the Israelites' doorposts was a sign that God would not destroy the family's firstborn (v. 7), and Jesus' blood is the sign that through His death, believers are saved from coming judgment. (7) None of the bones of the Passover lamb were to be broken (vv. 5, 46), and none of Jesus' bones were broken when He died (Ps. 34:20; John 19:33, 36), despite the brutality of His death.<sup>1</sup>

One writer believed that the first Passover was the origin of the concept of "the day of the LORD," which is so prominent in the writing prophets.<sup>2</sup> The "day of the LORD " that they referred to was likewise an instance of divine intervention, similar to what God did at the first Passover, involving judgment and blessing.

### **Directions for the Feast of Unleavened Bread 12:15-20**

The Feast of Unleavened Bread began with the Passover meal, and continued for seven more days (v. 15). The bread that the Jews used for these feasts contained no leaven (yeast), which made it like a cracker rather than a cake in its consistency. The Old Testament often uses leaven as a symbol of sin. Leaven gradually permeates dough, and it affects every part of the dough. Here it not only reminded the Israelites, in later generations, that their ancestors fled Egypt in haste, before their dough could rise. It also reminded them that their lives should resemble the unleavened bread as redeemed people, namely, free from sin. Bread is "the staff of life," and it represents life. The life of the Israelites was to be separate from sin, since they had received new life—extended life—as a result of God's provision of the Passover lamb. Eating unleavened bread for a week, and removing all leaven from their houses would have impressed the necessity of a holy life upon the Israelites.

"For us the leaven must stand for the selfness which is characteristic of us all, through the exaggerated instinct of self-preservation and the heredity received through generations, which have been a law to themselves, serving the desires of the flesh and of the mind. We are by nature self-

---

<sup>1</sup> *The Nelson ...*, p. 118.

<sup>2</sup> Benno Jacob, *The Second Book of the Bible: Exodus*, p. 315.

confident, self-indulgent, self-opinionated; we live with self as our goal, and around the pivot of I our whole being revolves."<sup>1</sup>

Anyone who refused to abide by these rules repudiated the spiritual lesson contained in the symbols, and was therefore "cut off from Israel" (v. 15). This phrase means to experience separation from the rights and privileges of the nation through excommunication or, more often, death (cf. Gen. 17:14; Exod. 30:33, 38; 31:14; et al.).<sup>2</sup>

"For willful, conscious, high-handed profanity, whether in reference to the Temple or to God, the law does not appear to have provided any atonement or offering [cf. Heb. 10:26-27]."<sup>3</sup>

The Mosaic Law later specified two types of punishment that are easy to confuse:

"The one, often referred to in the warning 'that he die not,' is called by the Rabbis, 'death by the hand of Heaven or of God;' the other is that of being 'cut off [e.g., Exod. 30:33, 38; 31:14; Lev. 7:20, 21, 25, 27; 17:4; et al.]'. It is difficult to distinguish exactly between these two. Tradition enumerates thirty-six offences to which the punishment of 'cutting off' attaches. From their graver nature, as compared with the eleven offences on which 'death by the hand of God' was to follow, we gather that 'cutting off' must have been the severer of the two punishments, and it may correspond to the term 'fiery indignation [Heb. 10:27, AV]'. Some Rabbis hold that 'death by the hand of God' was punishment which ended with this life, while 'cutting off' extended beyond it. But the best authorities maintain, that whereas death by the hand of Heaven fell upon the guilty individual alone, 'the cutting off' extended to the children also so that the family would become extinct in Israel."<sup>4</sup>

---

<sup>1</sup>Meyer, pp. 138-39.

<sup>2</sup>Cf. Keil and Delitzsch, 1:224; and Gordon J. Wenham, *The Book of Leviticus*, pp. 241-2.

<sup>3</sup>Edersheim, p. 65.

<sup>4</sup>Ibid., p. 66.

"Playing fast and loose with God's prescribed practices is to show disrespect for God's honor and dignity."<sup>1</sup>

The Israelites celebrated the Passover on the fourteenth of Abib, and the Feast of Unleavened Bread continued through the twenty-first (v. 18). God's call to the Israelites to live holy lives arose from what God had done for them. Consecration follows redemption; it is not a prerequisite for redemption. Similarly, God calls Christians to be holy, in view of what He has done for us (cf. Rom. 12:1-2). He does not say that we can experience redemption if we become holy first.

Sunset ("evening," v. 18) ended one day and began the next for the Jews (cf. Gen. 1:5; et al.).

### **The communication and execution of the directions concerning the Passover 12:21-28**

Hyssop grew commonly on rocks and walls in the Near East and Egypt (v. 22). If it was probably the same plant that we identify as hyssop today, or very close to it. Masses of tiny white flowers and a fragrant aroma characterized it. The Jews used it for applying blood to the door in the Passover ritual, because of its availability and suitability as an applicator of liquids—something like a paint brush. They also used it in the purification rite for lepers (Lev. 14:4, 6), the purification rite for a plague (Lev. 14:49-52), and in the red heifer sacrifice ritual (Num. 19:2-6).

"The hairy surface of its leaves and branches holds liquids well and makes it suitable as a sprinkling device for purification rituals."<sup>2</sup>

"The people were instructed that the only way they could avert the 'destroyer' was to put the blood of the lamb on their doorposts. Though the text does not explicitly state it, the overall argument of the Pentateuch ... would suggest that their obedience to the word of the Lord in this instance was an evidence of their faith and trust in him [cf. Heb. 11:28]."<sup>3</sup>

---

<sup>1</sup>Waltke, *An Old ...*, p. 466.

<sup>2</sup>Youngblood, p. 61.

<sup>3</sup>Sailhamer, *The Pentateuch ...*, p. 263.

God, through Moses, stressed the significance and the importance of perpetuating the Passover (v. 26).

"The Israelitish child will not unthinkingly practice a dead worship; he will ask: What does it mean? and the Israelitish father must not suppress the questions of the growing mind, but answer them, and thus begin the spiritualizing [the explanation of the spiritual significance] of the paschal rite."<sup>1</sup>

"As detailed in the earliest Jewish record of ordinances—the *Mishnah*—the service of the Paschal Supper was exceedingly simple. ... *The Passover lamb* means that God passed over the blood-sprinkled place on the houses of our fathers in Egypt; *the unleavened bread* means that our fathers were delivered out of Egypt (in haste); and *the bitter herbs* mean that the Egyptians made bitter the lives of our fathers in Egypt."<sup>2</sup>

Worship and obedience occur together again here (vv. 27-28). These are the two proper responses to God's provision of redemption. They express true faith. These are key words in Exodus.

"The section closes with one of those rare notices in Israel's history: they did exactly what the Lord had commanded (v. 28)—and well they might after witnessing what had happened to the obstinate king and people of Egypt!"<sup>3</sup>

"By this act of obedience and faith, the people of Israel made it manifest that they had put their trust in Jehovah; and thus the act became their redemption."<sup>4</sup>

## **2. The death of the firstborn and the release of Israel** **12:29-36**

The LORD struck the Egyptians at midnight, the symbolic hour of judgment (v. 29; cf. Matt. 25:5-6), when they were asleep "... to startle the king and

---

<sup>1</sup>J. P. Lange, "Exodus or the Second Book of Moses," in *Lange's Commentary on the Holy Scripture*, 1:2:39-40.

<sup>2</sup>Edersheim, pp. 236, 237, quoting Rabbi Gamaliel in Pes. 10:15 of the *Mishnah*.

<sup>3</sup>Kaiser, "Exodus," p. 376.

<sup>4</sup>Johnson, p. 62.

his subjects out of their sleep of sin."<sup>1</sup> Pharaoh had originally met Moses' demands with contemptuous insult (5:4). Then he tried a series of compromises (8:25, 28; 10:8-11, 24). All of these maneuvers were unacceptable to God.

There is evidence from Egyptology that the man who succeeded Amenhotep II, the pharaoh of the plagues, was not his firstborn son.<sup>2</sup> His successor was Thutmose IV (1425-1417 B.C.), a different son of Amenhotep II, but evidently not his firstborn. Thutmose IV went to some pains to legitimize his right to the throne. This would not have been necessary if he had been the firstborn. So far scholars have found no Egyptian records of the death of Amenhotep II's firstborn son.

"Thutmose IV claimed that when he was still a prince he had a dream in which the sun god promised him the throne; this implies that he was not the one who would be expected to succeed to the throne under normal circumstances."<sup>3</sup>

Joseph also had dreams that assured him that he would have a leadership role.

In contrast to the former plagues, this one was not just a heightened and supernaturally directed natural epidemic, but a direct act of God Himself (cf. vv. 12, 13, 23, 27, 29)—though death, of course, is natural.

We need to understand the statement "there was no home in where there was not someone dead" in its context (v. 30). There was no Egyptian home in which there was a firstborn son, who was not a father himself, that escaped God's judgment of physical death.

Why did God take the lives of all the firstborn Egyptians when the Egyptian people had no control over Pharaoh's decision not to allow the Israelites to leave Egypt?

"There is no way for nations to be dealt with other than on a collective basis. The fortunes of the citizens of any country are bound up with the government that guides their national

---

<sup>1</sup>Keil and Delitzsch, 2:23.

<sup>2</sup>See Unger, *Archaeology and ...*, pp. 142-44; Gleason Archer, *A Survey ...*, pp. 229-30; Pritchard, p. 449.

<sup>3</sup>Gispen, p. 113. Cf. Wood, *A Survey ...*, p. 128.

policy whether that government be a democracy, a party dictatorship, or monarchy."<sup>1</sup>

"This series of five imperative verbs [in v. 31], three meaning 'go' (*dlh* is used twice) and one meaning 'take,' coupled with five usages of the emphatic particle *mg* 'also' ..., marvelously depicts a Pharaoh whose reserve of pride is gone, who must do everything necessary to have done with Moses and Israel and the Yahweh who wants them for his own."<sup>2</sup>

Pharaoh's request that Moses would bless him is shocking, since the Egyptians regarded Pharaoh as a god. A god, obviously, would not normally humble himself by asking to be blessed (v. 32; cf. Gen. 47:7). This request shows how humiliated Pharaoh had become.

The reader sees God in two roles in this section, representing the two parts of Israel's redemption. He appears as the Judge, satisfied by the blood of the innocent sin-bearer, and He is the Deliverer of Israel, who liberated the nation from its slavery.

Redemption involves the payment of a price. What was the price of Israel's redemption? It was the lives of the lambs that God provided as the substitutes for Israel's firstborn sons, who would have died otherwise (cf. Isaac in Gen. 22, and Jesus Christ, the only-begotten of the Father). The firstborn sons remained God's special portion (Num. 8:17-18). The Egyptian firstborn sons died as a punishment on the Egyptians. The Egyptians had enslaved God's people and had not let them go, and they had executed an enormous number of male Israelite babies (1:15-22), possibly over the last 80 years.<sup>3</sup>

God owns all life. He just leases it to His creatures. We have a lease on life. God paid the price of Israel's redemption to Himself. He purchased the nation to be a special treasure for Himself, and for a special purpose (19:5). This redemption resulted in Israel's liberation and adoption.

"The Israelites march out of Egypt through the front door, with dignity—not like dogs crawling through the back fence, but like

---

<sup>1</sup>Archer, *Encyclopedia of ...*, p. 113.

<sup>2</sup>Durham, p. 167.

<sup>3</sup>Ramm, p. 79.

God's people. This exaltation of Israel is another humiliation for Egypt."<sup>1</sup>

### 3. The exodus of Israel out of Egypt 12:37-42

"Out of the events which manifest God's coming into history faith has selected and, as a faithful interpreter of Yahweh's plan, has retained two main ones, the first at the beginning, the second at the end of history—the Exodus and the Day of Yahweh: between these two extremes there are, of course, many interventions of Yahweh but they only serve to confirm and make explicit the initial revelation of the Exodus or to announce the future kingship of Yahweh."<sup>2</sup>

12:37-39 The record of Israel's sojourn in the wilderness really begins here.

"Rameses" is probably the same city as Raamses, also called Avaris (v. 37; cf. 1:11). Many critical scholars date the Exodus in the thirteenth century B.C. because of this reference to Rameses. Rameses II ruled Egypt at that later date. However, Rameses may very well be a later name for this site.<sup>3</sup> This may be an instance of later scribal updating.

"The most likely explanation is that the name Raamses had already been used by the Hyksos kings many years before the Nineteenth Dynasty."<sup>4</sup>

Rameses was the city from which the Israelites left Egypt, and it lay somewhere east of the Nile delta in the land of Goshen. Archaeologists have not identified Succoth with certainty, either. However, from the context, it seems that Succoth was only a few miles from Rameses. It may have been a district

---

<sup>1</sup>Enns, p. 250.

<sup>2</sup>Edmond Jacob, *Theology of the Old Testament*, p. 190.

<sup>3</sup>Unger, *Archaeology and ...*, p. 149.

<sup>4</sup>Wood, *A Survey ...*, p. 93.

rather than a town.<sup>1</sup> Perhaps Cassuto was right when he wrote the following:

"Succoth was a border town named in Egyptian Tkw. Here the name appears in a Hebrew or Hebraized form. Apparently it was situated at the *tell* called by the Egyptians today Tell el-Maskhuta."<sup>2</sup>

Many commentators concluded that, since there were about 600,000 Israelite men (Heb. *hageberim*), the total number of Israelites must have been about two million. Though the Hebrew word translated "thousand" (*eleph*) can also mean "family," "clan," "military unit," or something else, most translators have preferred "thousand" (cf. Exod. 38:26; Num. 1:45-47). In view of the incongruities posed by such a large number (cf. Exod. 13:17; 14:21-31; 16:3-4; 17:8-13; 18:14-16; 23:29-30; Num. 14; Deut. 7:7, 22; Josh. 7:5; et al.), *eleph* may have meant "hundred" or "unit of ten" or some other number smaller than "thousand," though the evidence to support this theory is presently weak, in my opinion.<sup>3</sup>

"God will not leave small children behind at the time of the Rapture any more than He left them behind when the Israelites were redeemed and left the land of Egypt."<sup>4</sup>

Moses referred to the "mixed multitude" often, in the account of the wilderness wanderings that follows. This group probably included Egyptian pagans and some God-fearers (v. 38; cf. 9:20), plus an assortment of other people, including other enslaved Semites. For one reason or another, these people took this opportunity to leave or escape from Egypt along with the Israelites. This group proved to be a source of trouble in

---

<sup>1</sup>Edward Naville, *The Store-City of Pithom and the Route of the Exodus*, p. 23; Kaiser, "Exodus," p. 379.

<sup>2</sup>Cassuto, 147.

<sup>3</sup>See Wood, *A Survey ...*, pp. 154-55.

<sup>4</sup>McGee, 1:237.



Israel, and led the Israelites in complaining and opposing Moses (e.g., Num. 11:4).

12:40-42 The text is very definite that Israel was in Egypt "430 years, on this very day" (v. 41). This probably refers to the time, beginning when Jacob entered Egypt with his family (1876 B.C.), to the day of the Exodus (1446 B.C.). Josephus wrote that it was from the time Abraham entered Canaan, and that it was only 215 years after Jacob relocated into Egypt, but this seems incorrect.<sup>1</sup> Gaebelien wrote that it was from the day on which Abraham left Ur, but this too seems inaccurate.<sup>2</sup>

Galatians 3:17 also refers to "430 years." This figure, however, probably represents the time from God's last reconfirmation of the Abrahamic Covenant to Jacob, at Beersheba (1875 B.C.; Gen. 46:2-4), to the giving of the Mosaic Law at Sinai (1446 B.C.; Exod. 19). Genesis 15:13, 16 and Acts 7:6 give the time of the Israelites' enslavement in Egypt as "400 years" (1846-1446 B.C.). The "about 450 years," spoken of in Acts 13:19, includes the 400-year sojourn in Egypt, the 40 years of wilderness wanderings, and the seven-year conquest of the land (1875-1395 B.C.).<sup>3</sup>

---

<sup>1</sup>Josephus, *Antiquities of ...*, 2:15:2.

<sup>2</sup>Gaebelien, 1:1:138.

<sup>3</sup>Harold W. Hoehner, "The Duration of the Egyptian Bondage," *Bibliotheca Sacra* 126:504 (October-December 1969):306-16, presented three other ways to reconcile these references. See Wood, *A Survey ...*, pp. 83-88, for a thorough discussion of these options.

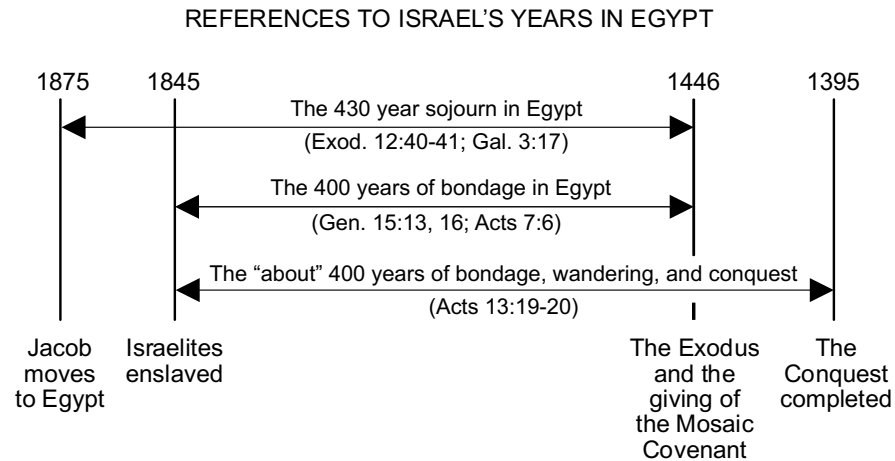

"God never fulfils His promises without first leading His people to *expect* the fulfilment [cf. Gen. 15:13]."<sup>1</sup>

Why would God allow His chosen people to suffer for so long in Egypt before He delivered them? Undoubtedly it was so that they would learn to detest Egypt and long for the Promised Land. Similarly, God allows sinners to suffer to wean them from the world and make them long for a better "land."

Many modern liberal scholars deny that the Exodus ever took place, often because there is little—if any, they say—extra-biblical evidence to support it. However, Josephus believed that it happened, and refuted Manetho, an ancient Egyptian writer, who also believed that it happened, but incorrectly represented it.<sup>2</sup>

"... Egypt has afforded us no direct evidence of the sojourn of the Israelites, but it has revealed much which makes that sojourn and the Exodus which followed entirely credible. There are many connections between life in Egypt as known from archaeology and the details of the biblical narrative at this point."<sup>3</sup>

<sup>1</sup>George Wagner, *Practical Truths from Israel's Wanderings*, p. 3.

<sup>2</sup>Josephus, *Against Apion*, 1:15. Cf. *ibid.*, 2:1-3, 41.

<sup>3</sup>Finegan, p. 134.

"The Mosaic tradition is so consistent, so well attested by different pentateuchal documents, and so congruent with our independent knowledge of the religious development of the Near East in the late second millennium B. C., that only hypercritical pseudo-rationalism can reject its essential historicity."<sup>1</sup>

Scholars have debated hotly, and still argue about, the date of the Exodus. Many conservatives hold a date very close to 1446 B.C.<sup>2</sup> Their preference for this date rests first on 1 Kings 6:1, that states that the Exodus took place 480 years before the fourth year of Solomon's reign. That year was quite certainly 967 B.C. Second, this view harmonizes with Judges 11:26, which says 300 years elapsed between Israel's entrance into Canaan and the commencement of Jephthah's rule as a judge.<sup>3</sup> Third, the length of the Judges Period argues for this date. Fourth, this date harmonizes better with events in Egyptian history.

Most liberals, and many evangelicals, hold to a date for the Exodus about 1290 B.C.<sup>4</sup> This opinion rests on the belief that the existence of the city of Raamses (1:11; et al.) presupposes the existence of Pharaoh Ramses II (ca. 1300-1234 B.C.).<sup>5</sup> Also, advocates of this view point to supposed similarities between the times of Pharaoh Ramses II and the Exodus period.<sup>6</sup> Another possible reason for dating the Exodus to the thirteenth century

---

<sup>1</sup>W. F. Albright, *Archaeology and the Religion of Israel*, p. 96.

<sup>2</sup>See, for example, Wolf, pp. 141-48; Free, pp. 98-99.

<sup>3</sup>See Ronald Youngblood, "A New Look at an Old Problem: The Date of the Exodus," *Christianity Today* 26:20 (Dec. 17, 1982):58, 60; Charles Dyer, "The Date of the Exodus Reexamined," *Bibliotheca Sacra* 140:559 (July-September 1983):225-43; Archer, "Old Testament History ...," pp. 106-9; Bruce K. Waltke, "Palestinian Artifactual Evidence Supporting the Early Date of the Exodus," *Bibliotheca Sacra* 129:513 (January-March 1973):33-47.

<sup>4</sup>E.g., R. K. Harrison, *Introduction to the Old Testament*, pp. 315-25; Kenneth Kitchen, *Ancient Orient and Old Testament*, pp. 73-75; Kathleen Kenyon, *The Bible and Recent Archaeology*, p. 30; Durham, p. xxvi; James K. Hoffmeier, "What Is the Biblical Date for the Exodus? A Response to Bryant Wood," *Journal of the Evangelical Theological Society* 50:2 (June 2007):225-47. For refutation of the late date theory, see Bryant G. Wood, "The Rise and Fall of the 13th-Century Exodus-Conquest Theory," *Journal of the Evangelical Theological Society* 48:3 (September 2005):475-89; idem, "The Biblical Date for the Exodus is 1446 BC: A Response to James Hoffmeier," *Journal of the Evangelical Theological Society* 50:2 (June 2007):249-58.

<sup>5</sup>See my comments on 1:11 above.

<sup>6</sup>See Finegan, pp. 113-21.

B.C. is the archaeological remains in Palestine that have been attributed to the conquest. However, there is good reason to identify these ruins with the destruction that took place during the Judges Period of Israel's history.<sup>1</sup>

Another view has also been popularized that places the Exodus about 1470 B.C. But it, too, is not as credible as the 1446 B.C. view, in my opinion.<sup>2</sup>

The generally recognized oldest extra-biblical reference to Israel is on the Merneptah Stele, dated quite precisely to somewhere between 1210 and 1205 B.C.<sup>3</sup> This stele is in the Egyptian Museum in Cairo. However, an older reference to Israel has now been claimed to exist on a gray granite slab, 18 inches high and 15 1/2 inches wide, in the Egyptian Museum of Berlin. This stone is 200 years older than the Merneptah Stele.<sup>4</sup>

#### **4. Regulations regarding the Passover 12:43-51**

Before any male could eat the Passover, he had to undergo circumcision. Moses stressed this requirement strongly in this section. The rationale behind this rule was that before anyone could observe the memorial of redemption, he first had to exercise faith in the promises God had given to Abraham. Furthermore, he had to demonstrate that faith by submitting to the rite of circumcision, the sign of the Abrahamic Covenant. This requirement should have reminded the Israelites, and all other believers who partook of the Passover, that the Passover rite did not make a person acceptable to God. Faith in the promises of God did that. Foreigners who were non-Israelites could and did become members of the nation—by faith in the Abrahamic Covenant promises. Participation in the rite of circumcision was a testimony to that faith. There were both circumcised and uncircumcised foreigners who lived among the Israelites during the wilderness march.

---

<sup>1</sup>Longman and Dillard, pp. 65-66.

<sup>2</sup>See John J. Bimson, *Redating the Exodus and the Conquest*; and idem, "Redating the Exodus," *Biblical Archaeology Review* 13:5 (September-October 1986):40-53, 66-68. See Livingston, *The Pentateuch ...*, pp. 41-50; or L. Wood, *A Survey ...*, pp. 88-109, for further discussion of the date of the Exodus.

<sup>3</sup>See Frank J. Yurco, "3,200-Year-Old Picture of Israelites Found in Egypt," *Biblical Archaeology Review* 16:5 (September/October 1990):22-38; Finegan, pp. 115-17.

<sup>4</sup>Hershel Shanks, "When Did Ancient Israel Begin?" *Biblical Archaeology Review* 38:1 (January/February 2012):59-62, 67.

Here Moses revealed the requirement that the Passover host was not to "break any bone" of the paschal lamb (v. 46; cf. vv. 3-9). Not a bone of the Lamb of God was broken either (John 19:36).

What did the Israelites have to believe to be saved eternally? Though this is nowhere explained explicitly in Scripture, I believe they obtained eternal salvation by believing that God provided redemption for them in the sacrificial lambs at the Passover in Egypt. Throughout the Old Testament, the prophets reminded the Israelites of the Exodus as God's great saving act for them; and, of course, the Exodus was the result of the Passover.

Similarly, we who are New Testament believers believe that God provided redemption for us, in the sacrificial Lamb of God at Calvary. The New Testament writers continually reminded us of Calvary as God's great saving act for us. To participate in the annual Passover feast, an Israelite male had to be circumcised. Circumcision was the sign that he had personally placed his faith in God, just as circumcision for Abraham expressed his personal faith in God. Water baptism is a similar sign of faith in God today, if it is "believers' baptism." I do not believe there is adequate evidence in the Old Testament, or in the New Testament, that the Israelites were saved by faith in a coming Messiah. Even though there were promises of a coming Messiah, the Old Testament writers did not connect faith in those promises with salvation—in a cause and effect relationship.

"If I were asked what is the greatest story in all the Old Testament, I should say it is the story of the Passover ..."<sup>1</sup>

The *basis* of salvation is always the death of Christ. No one is saved except by what He accomplished at Calvary. The *requirement* for salvation is always faith. It is never works. The *object* of faith is always the Person of God. The *content* of faith is always a promise from God.

"So what was the content of the saving faith of people in Old Testament times? It was in believing two things: God delivered His people from Egypt, and this deliverance was for 'us' as well as for them."<sup>2</sup>

The *promise* of God differed from age to age: For example, I think that Adam probably believed God's promise that He would eventually overcome

---

<sup>1</sup>G. Campbell Morgan, *The Unfolding Message of the Bible*, p. 20.

<sup>2</sup>Ronald B. Allen, *The Wonder of Worship*, p. 66.

Satan (Gen. 3:15). Abraham probably believed that God would fulfill His promises to Him regarding seed, land, and blessing (Gen. 15:6). The Israelites had to believe God's promise that the blood of the Passover lamb delivered them (Exod. 12:13). Christians have to believe that the blood (death) of the Lamb of God satisfied God's righteous claims against them (John 3:16; cf. 1 John 2:2).

In the ancient biblical world, women were regarded as participating in the acts of the male who was in authority over them: the father if a single woman, or the husband if married. So if a woman's father or husband trusted in God's substitute sacrifice, she was counted as doing the same thing. This was customary in the ancient Near Eastern world. Probably there were cases where the husband believed and his wife did not, but as a rule women in that culture adopted the beliefs of their husbands (or fathers).

Was the Old Testament believer eternally secure? Yes, because justification is always a judicial decision (Gen. 15:6; Deut. 25:1; cf. Rom. 5:1). When God declares a person righteous, which is what justification involves, His declaration remains in effect regardless of the justified person's subsequent behavior. People do not obtain salvation by being good, and they do not lose their salvation by being bad. Salvation is a work that God does for sinners out of His grace. It is not something that we can obtain—or retain—by our actions. When we trust Him, He transfers us "from the domain of darkness" to "the kingdom of His beloved Son" (Col. 1:13). Having been born again into His family, we can never be unborn; we remain His children forever (cf. Rom. 8:31-38). When we sin, He disciplines us as His sons, but He does not throw us out of His family (cf. Heb. 12:6-7).

### **5. The sanctification of the firstborn 13:1-16**

This section is somewhat repetitive, but the emphasis is on the LORD's right to the firstborn in Israel, and how the Israelites were to acknowledge that right. The repetition stresses its importance.

- 13:1-2 "Every firstborn" refers to the males only (v. 2). This is clear from the Hebrew word used and the context (vv. 12, 13).
- 13:3-10 The Passover Feast was to be a sign to the Israelites of God's powerful work for them.

13:11-16 The dedication of every firstborn Israelite male baby was to take place after the nation had entered the Promised Land (vv. 5, 11-12). This was originally to be a memorial of God's redemption from Egyptian slavery, as were the feasts of Passover and Unleavened Bread (cf. 12:14). However, God took the Levites for His special possession in place of the firstborn. This happened at Mt. Sinai (Num. 3:12-13). Consequently, this firstborn dedication never took place, but the Israelites did circumcise their sons and observe the Passover when they first entered the Promised Land (Josh. 5:4-7).

God probably did not intend that the Jews should literally wear phylacteries (lit. frontlet-bands, or head-bands, v. 16; Heb. *tephilin*). Probably He meant that His claim on the firstborn males should always remain prominently in the Israelites' memories—like a mark on their hand, and like a head-band on their forehead would remind them of something important.

"The line of thought referred to merely expresses the idea, that the Israelites were not only to retain the commands of God in their hearts, and to confess them with the mouth, but to fulfil them with the hand, or in act and deed, and thus to show themselves in their whole bearing as the guardians and observers of the law. As the hand is the medium of action, and carrying in the hand represents handling, so the space between the eyes, or the forehead, is that part of the body which is generally visible, and what is worn there is worn to be seen. This figurative interpretation is confirmed and placed beyond doubt by such parallel passages as Prov. iii. 3, 'Bind them (the commandments) about thy neck; write them upon the tables of thine heart' (cf. vers. 21, 22, iv. 21, vi. 21, 22, vii. 3)."<sup>1</sup>

"For two thousand years and more, observant Jews have taken those passages literally. The

---

<sup>1</sup>Keil and Delitzsch, 2:37.

paragraphs that form their contexts (Exod. 13:1-10; 13:11-16; Deut. 6:4-9; 11:13-21) are written on four strips of parchment and placed in two small leather boxes, one of which the pious Jewish man straps on his forehead and the other on his left arm before he says his morning prayers. The practice may have originated as early as the period following the exile to Babylon in 586 B.C.

"It hardly needs to be said that there is nothing inherently wrong with such a custom. The boxes, called 'phylacteries' are mentioned in Matthew 23:5, where Jesus criticizes a certain group of Pharisees and teachers of the law for wearing them. Our Lord, however, condemns not the practice as such but the ostentatious use of 'wide' phylacteries as part of a general statement about those who flaunt their religiosity in public: 'Everything they do is done for men to see.'

"But although the proper and modest use of phylacteries might be spiritually legitimate, it is probably best to understand the references from Exodus and Deuteronomy as figures of speech, since similar statements are found elsewhere in the Old Testament."<sup>1</sup>

The Jewish practice of wearing phylacteries seems to have originated in the Babylonian captivity.<sup>2</sup>

John Durham divided the Book of Exodus into two parts, and he believed the first part ends here:

"With Yahweh's Presence promised, then demonstrated, then given to Israel in theophany at Sinai, the first half of Exodus ends. The second half of the book is preoccupied with response to that Presence, in life, in covenant, in worship, and even in disobedience. The largest part of that second half has

---

<sup>1</sup>Youngblood, pp. 66-67.

<sup>2</sup>Kaiser, "Exodus," revised ed., p. 436



to do with the communication to Israel of the reality of that Presence, through a series of set-apart places, set-apart objects and set-apart acts, all of them intimately connected, in one way or another, with Yahweh's Presence."<sup>1</sup>

#### D. GOD'S COMPLETION OF ISRAEL'S LIBERATION 13:17—15:21

The Israelites now began their migration from Goshen to Canaan.

As mentioned previously, critics of the Bible have claimed that there never was an exodus of the Israelites from Egypt, because there is no record of it in Egyptian antiquities.

"A study of the monuments, however, shows that the Egyptians did not record matters uncomplimentary to themselves. ... Furthermore, when something was recorded which proved to be uncomplimentary or distasteful to a later regime, it was effaced at the first opportunity."<sup>2</sup>

#### 1. The journey from Succoth to Etham 13:17-22

"The way of the land of the Philistines" refers to the most northern of three routes travelers normally took from Egypt to Canaan (v. 17). The others lay farther south. The Egyptians had heavily fortified this caravan route, also called the *Via Maris* (the way of the sea). The Egyptians would have engaged Israel in battle had the chosen people gone that way.

"When you were weak, and yet very unconscious of your weakness [as the Israelites were at this time], God would not suffer you to encounter the Philistines. It would have been too much for you ..."<sup>3</sup>

The people marched in an orderly fashion (v. 18). This is the meaning of "in battle formation." Moses had not yet organized them as an army.

---

<sup>1</sup>Durham, p. 501.

<sup>2</sup>Free, p. 98.

<sup>3</sup>Wagner, p. 28.

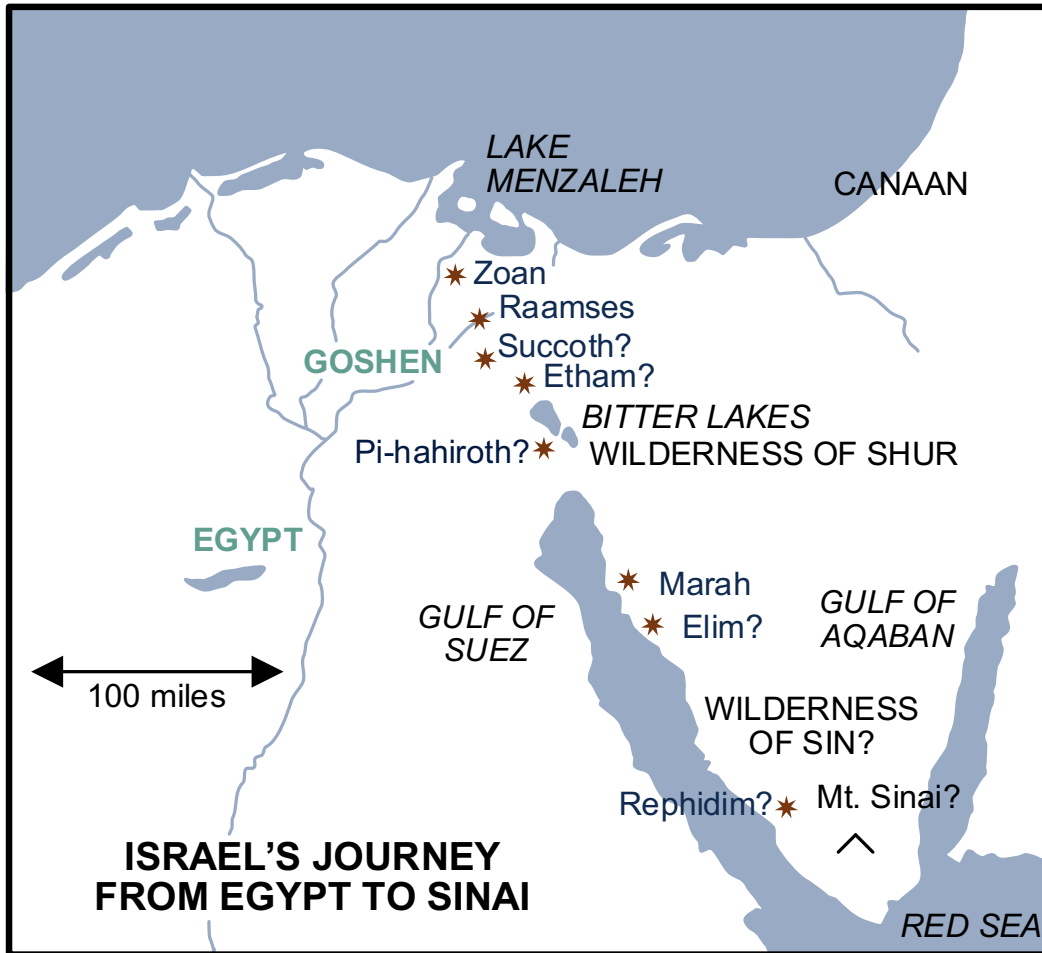

Succoth (v. 20) was evidently north and west of the Bitter Lakes. Today the Suez Canal connects the Red Sea with the Mediterranean by way of the Bitter Lakes. Archaeologists have not yet identified with certainty the sites referred to here, such as Succoth and Etham, as well as many others of those mentioned in the records of the Israelites' journey (e.g., Num. 33). Consequently, it is virtually impossible to pin down their exact locations. Many of these sites were nothing more than stopping points or oases; they were not established towns. Kaiser wrote concerning their locations, "Everyone is guessing!"<sup>1</sup> The only stopping-place in the wilderness wanderings that scholars have been able to identify without dispute is Kadesh Barnea.<sup>2</sup>

<sup>1</sup>Kaiser, "Exodus," p. 385.

<sup>2</sup>See various Bible Atlases for supposed routes.

The "wilderness" referred to in verse 20 would have been the "Wilderness of Shur" located to the east of the Nile delta.

There was only one pillar: a pillar of cloud by day, and a pillar of fire by night, v. 21; cf. 14:24). John Sailhamer believed there was one pillar of cloud and a second and different pillar of fire, but this is a rare interpretation.<sup>1</sup>

"Like the burning bush (3:2), the pillar was the visible symbol of God's presence among His people. The Lord Himself was in the pillar (13:21; 14:24) and often spoke to the people from it ([chs. 19—20;] Num. 12:5-6; Deut. 31:15-16; Ps. 99:6-7). The later hymn-writers of Israel fondly remembered it (Pss. 78:14; 105:39). A similar cloud of smoke came to represent the glory of the Lord in the sanctuary throughout much of Israel's history (Exod. 40:34-35; 1 Kings 8:10-11; Isa. 4:5; 6:3-4)."<sup>2</sup>

"Some make this cloud a type of Christ. The cloud of his human nature was a veil to the light and fire of his divine nature. Christ is our way, the light of our way and the guide of it."<sup>3</sup>

The pillar of cloud and fire, the token of God's presence, remained over the Israelites until they entered Canaan under Joshua's leadership (v. 22; cf. 3:2; 20:18). Perhaps it appeared as Meyer imagined it:

"When the excessive heat made it necessary for Israel to march at night, the light of the Fiery Pillar was enough to light the way: and when in the day the scorching glare of the sun was blinding, the cloud spread itself abroad like a great umbrella, so that the women and children could travel in comparative comfort [cf. Ps. 84:11]."<sup>4</sup>

"Thus, brethren, it is evident that there was no exercise of faith whatever as to what *was* the *will* of God concerning them. The only exercise of faith to which they were called was to do

---

<sup>1</sup>Sailhamer, *The Pentateuch ...*, p. 269.

<sup>2</sup>Youngblood, pp. 74-75. See also Richard D. Patterson, "The Imagery of Clouds in the Scriptures," *Bibliotheca Sacra* 165:657 (January-March 2008):24-25.

<sup>3</sup>Henry, p. 86.

<sup>4</sup>Meyer, p. 158.

that will made manifest by the pillar of fire and cloud, and follow Jehovah's merciful guidance with unfaltering and contented hearts. It was in *this* that they were so often tried, and in *this* that they so often failed. We, brethren, live under an advanced dispensation,—the dispensation of the Spirit; and are therefore called to higher exercises of faith,—of that faith which discerns the will of God in circumstances of difficulty, as well as that which walks in it when discerned."<sup>1</sup>

## 2. Israel's passage through the Red Sea ch. 14

14:1-4 Scholars have not been able to locate definitely the sites referred to in verse 2.

"Both Pi-hahiroth and Migdol are found mentioned in Egyptian inscriptions, but have not been identified."<sup>2</sup>

"An Egyptian papyrus associates Baal Zephon with Tahpahnes ... a known site near Lake Menzaleh in the northeastern delta region."<sup>3</sup>

However, it seems that the crossing took place farther south in view of the implication that it took the Israelites no less and no more than three days to reach Marah (15:22-23). The evidence for the location of Marah seems a bit stronger.

"Yahweh's first intention was to give the appearance that Israel, fearful of the main road, then fearful of the wilderness, was starting first one way and then another, not knowing where to turn and so a ready prey for recapture or destruction. Yahweh's second intention was to lure the Egyptians into a trap, first by making Pharaoh's mind obstinate once again, and then by defeating Pharaoh and his forces, who were

---

<sup>1</sup>Wagner, p. 31.

<sup>2</sup>L. Wood, *A Survey ...*, p. 130, n. 78.

<sup>3</sup>Youngblood, p. 75.

certain to come down in vengeance upon an apparently helpless and muddled Israel."<sup>1</sup>

"Like a master chess player, God induces Pharaoh to move his king into checkmate, and he doesn't even realize it."<sup>2</sup>

The Hebrew phrase *yam sup*, that Moses used to describe the body of water through which the Israelites passed miraculously, means "Red Sea," not "Reed Sea."

"If there is anything that sophisticated students of the Bible *know*, it is that *yam sup*, although traditionally translated Red Sea, really means Reed Sea, and that it was in fact the Reed Sea that the Israelites crossed on their way out of Egypt. Well it doesn't and it wasn't and they're wrong!"<sup>3</sup>

In the article quoted above, the writer explained that the word *sup* did not originate in the Egyptian language but in Hebrew. Many scholars have claimed that it came from an Egyptian root word meaning "reed." But this writer showed that it came from a Hebrew root word meaning "end." *Yam* is also a Hebrew word that means "sea." The "*yam sup*" is then the "Sea at the End." The ancients used the name *yam sup* to describe the body of water that lay beyond the farthest lands known to them. It meant the sea at the end of the world. It clearly refers to the Red Sea often in the Old Testament (Exod. 15:4; Num. 21:4; 33:8; Josh. 2:10; 4:23; 1 Kings 9:26; Jer. 49:21; et al.). The Greeks later used the same term, translated into Greek, to refer to the Persian Gulf and the Indian Ocean. The translation of *yam sup* as "Reed Sea" is evidently both inaccurate and misleading. It implies that the Israelites simply crossed some shallow marsh when they left Egypt. Such an interpretation

---

<sup>1</sup>Durham, p. 187.

<sup>2</sup>Enns, p. 271.

<sup>3</sup>Batto, p. 57. Paragraph division omitted.

lacks support in the inspired record of Israel's Exodus.<sup>1</sup> Nevertheless, many scholars still favor "Reed Sea."

"The Hebrew word *sup*, which corresponds closely to the Egyptian *tjuf* ('papyrus'), refers to the reeds along the bank of the Nile in Exodus 2:3 and to the seaweed in the Mediterranean in Jonah 2:5 [HB 2:6]. Since there are a series of lakes with abundant supplies of reeds and papyrus north of the Red Sea (the Gulf of Suez)—such as Lake Menzaleh and Lake Timsah—it is felt that one of these may have been the 'Reed Sea' crossed by the Israelites."<sup>2</sup>

"The rendering [']the Red Sea['] comes from the Septuagint, the Greek translation of the Old Testament completed about 150 B.C.; the Hebrew phrase means 'Sea of Reeds.'"<sup>3</sup>

Moses recorded that God hardened Pharaoh's heart three times in this chapter (vv. 4, 8, 17).

"Pharaoh and Egypt are ever-speaking witnesses of the danger of neglecting the first proffers of mercy, and of the sure end of that presumption which leads sinful man to oppose the will of God."<sup>4</sup>

"Our Father always gets glory when we let Him put us where only He can deliver us. Then we can sing His glorious praise as Israel did (Exod. 15; Ps. 116:12, 13; 40:1-3)."<sup>5</sup>

14:5-14

"This is the first time we read of the people of Israel crying out to God *en masse*. Isn't it

---

<sup>1</sup>For a summary of views on the site of crossing, see Davis, pp. 168-71, or Hyatt, pp. 156-61.

<sup>2</sup>Wolf, p. 140. HB refers to Hebrew Bible. See also *The New Bible Dictionary*, s.v. "Red Sea," by Kenneth A. Kitchen, pp. 1077-78; L. Wood, *A Survey ...*, p. 130.

<sup>3</sup>*The Nelson ...*, p. 122.

<sup>4</sup>Wagner, p. 8.

<sup>5</sup>William R. Newell, *Studies in the Pentateuch*, p. 124.

remarkable what a predicament will do to your proud, independent spirit?"<sup>1</sup>

This is also one of the first of Israel's many complaints against Moses and Yahweh that Moses recorded in Scripture. It is probably the first of ten incidents of complaining that culminated in God's judgment of them at Kadesh Barnea (v. 11; Num. 14:22-23). However, we have already seen that the Israelites occasionally opposed Moses and, behind him, God (2:14; 5:20-21).

"The suffering of Israel in the wilderness is recorded in Exodus 14—18. The purposes of the wilderness suffering—and this was before they reached Mount Sinai—varied. God wanted to test them to see if they would trust him (15:25b-26). And he wanted to challenge them to be his people and to live differently than all the other nations so that all peoples would know he is the Lord God (19:5-6). He wanted to teach them how to worship him in a manner different from that of other nations (Exodus 25—40). All of this occurs in the God-planned circumstances of suffering and subsequent necessary trusting."<sup>2</sup>

"God is not only in the business of saving us by getting us out of Egypt. He is also in the business of getting Egypt out of us as we navigate the wilderness, so that we can get to the Promised Land in the end."<sup>3</sup>

"God brings us into straits that he may bring us to our knees."<sup>4</sup>

"This is the first example in the Old Testament of what some scholars call 'holy war' or 'Yahweh war.' That is, this war was undertaken by the Lord

---

<sup>1</sup>Swindoll, *Moses ...*, p. 217.

<sup>2</sup>Bramer, p. 94.

<sup>3</sup>Charles R. Swindoll, *The Swindoll Study Bible*, p. 107.

<sup>4</sup>Henry, p. 86.

in defense of His own reputation, promises, and self-interest (14:10-14; see also, for example, 15:3; Deut. 1:30; 3:22; 20:4). It is to be distinguished from 'ordinary' war that Israel might undertake on her own (Num. 14:39-45)."<sup>1</sup>

Josephus wrote that the Egyptians pursued the Israelites with 600 chariots, 50,000 horsemen, and 200,000 footmen—all armed.<sup>2</sup> This may or may not be accurate (cf. vv. 7, 9).

"You know the human response to panic? First, we are afraid. Second, we run. Third, we fight. Fourth, we tell everybody. God's counsel is just the opposite. Don't be afraid. Stand still. Watch Him work. Keep quiet. It's then that He does it. He takes over! He handles it exactly opposite the way we'd do it. The Lord just taps His foot, waiting for us to wait."<sup>3</sup>

14:15-25 The time to act had come. Moses needed to stop praying and "go forward" (v. 15; cf. Josh. 7:6-13).

"It is quite certain, brethren, that there can be no progress in the Christian life without prayer,—without real and transforming communion with God; but you may also rest assured, brethren, that very much depends upon our 'going forward' at the right moment. ... Are you naturally hasty, imperious? ready to decide upon duty at once? Then you must make it a rule always to pray, before you give counsel, and act. Or are you naturally disposed to think, to deliberate and doubt? Then you must try to cultivate decision in action; you must 'go forward,' as well as 'pray.'"<sup>4</sup>

The strong east wind that God sent (v. 21) recalls the wind from God that swept over the face of the primeval waters in

---

<sup>1</sup>Merrill, in *The Old ...*, p. 54.

<sup>2</sup>Josephus, *Antiquities of ...*, 2:15:3.

<sup>3</sup>Swindoll, *Moses*, p. 219.

<sup>4</sup>Wagner, p. 43.



creation (Gen. 1:2). One wonders if this wind may have been a tornado or hurricane, and although tornados and hurricanes usually do not occur in that part of the world, this was a time in history when unusual weather events were happening.

"The parting of the water at Moses' command is the ultimate creation reversal [cf. Gen. 1:9]."<sup>1</sup>

The cloud became a source of light to the fleeing Israelites, but darkness to the pursuing Egyptians (vv. 19-20).

"Thus the double nature of the glory of God in salvation and judgment, which later appears so frequently in Scripture, could not have been more graphically depicted."<sup>2</sup>

The angel switched from guiding to guarding the Israelites. The strong east wind was another miracle, like those that produced the plagues (v. 21; cf. Ps. 77:16-19).

Two million Israelites could have passed through the sea in the time the text says ("all night," v. 21, perhaps 6 to 8 hours)—if they crossed in a wide column, perhaps as much as a half-mile wide. Some tornados and hurricanes have been known to cut a swath of devastation wider than this. Some interpreters take the wall of water (v. 22) literally, and others interpret it figuratively:

"The metaphor ["waters were *like* a wall"] is no more to be taken literally than when Ezra 9:9 says that God has given him a 'wall' (the same word) in Israel. It is a poetic metaphor to explain why the Egyptian chariots could not sweep in to right and left, and cut Israel off; they had to cross by the same ford, directly behind the Israelites."<sup>3</sup>

---

<sup>1</sup>Enns, p. 274.

<sup>2</sup>Kaiser, "Exodus," p. 389.

<sup>3</sup>Cole, p. 121. Cf. Cassuto, pp. 167-69.

Nevertheless, nothing in the text precludes a literal wall of water.<sup>1</sup> This seems to be the normal meaning of the text.

The text does not say that Pharaoh personally perished in the Red Sea (cf. vv. 8, 10, 28; Ps. 106:7-12; 136:13-15).<sup>2</sup>

14:26-31 Evidently the LORD sent a rainstorm after the Israelites had crossed safely (Ps. 77:17-18). This may have been part of the tornado or hurricane, if that is what the LORD used. The wet seabed would then account for the fact that the Egyptians' chariot wheels swerved (v. 26).

"They are drowned in the sea for drowning the Israelite children in the Nile."<sup>3</sup>

This miraculous deliverance produced fear (reverential trust) in Yahweh among the Israelites (v. 31). Their confidence in Moses as well as in God revived (cf. v. 10-12).

"... whenever confidence in Moses increases, as here and at Sinai, it is because of an action of Yahweh."<sup>4</sup>

"In view of the importance of the concept of faith and trust in God for the writer of the Pentateuch, we should take a long look at these verses. Just as Abraham believed God and was counted righteous (Ge 15:6), so the Israelites, under the leadership of Moses, also believed God. It seems reasonable that the writer would have us conclude here in the wilderness the people of God were living a righteous life of faith, like Abraham. As they headed toward Sinai, their trust was in the God of Abraham who had done great deeds for them. It is only natural, and certainly in line with the argument of the book, that they would break

---

<sup>1</sup>Davis, pp. 163-68, listed several ways of understanding what happened.

<sup>2</sup>Cole, p. 120. Cf. Jack Finegan, *Let My People Go*, p. 87; Oliver Blosser, "Did the Pharaoh of the Exodus Drown in the Red Sea?" *It's About Time*, (July 1987):11.

<sup>3</sup>Enns, p. 272.

<sup>4</sup>Durham, p. 197.

out into a song of praise in the next chapter. On the negative side, however, we should not lose sight of the fact that these same people would forget only too quickly the great work of God, make a golden calf (Ps 106:11-13), and thus forsake the God about whom they were now singing."<sup>1</sup>

"This great, climactic verse [v. 31] speaks of the genuine faith of the people of Israel at the end of their experience of God's saving works and at the beginning of their journey of faith. When we read [']so the people feared the LORD['] and the words that follow, we are meant to understand that the community had come to saving faith and so were a reborn people. They [']believed the LORD['] (the same wording used of Abraham's saving faith in Gen. 15:6; see Paul's comments, Rom. 4."<sup>2</sup>

"Here [v. 31] the title of 'servant' is given to Moses. This is the highest title a mortal can have in the OT—the 'servant of Yahweh.' It signifies more than a believer; it describes the individual as acting on behalf of God. For example, when Moses stretched out his hand, God used it as his own (Isa 63:12). Moses was God's personal representative."<sup>3</sup>

Many critics, who have sought to explain away God's supernatural deliverance of Israel, have attacked this story. They have tried by various explanations to account for what happened in natural terms, exclusively. It is obvious from this chapter, however, that regardless of where the crossing took place, enough water was present to drown the "entire army" of Egyptians that pursued Israel (v. 28). Immediately after this deliverance, the Israelites regarded their salvation as supernatural (15:1-21), and they continued to do so for generations (e.g., Ps. 106:7-8). The people of

---

<sup>1</sup>Sailhamer, *The Pentateuch ...*, p. 270.

<sup>2</sup>*The Nelson ...*, p. 124.

<sup>3</sup>*The NET2 Bible* note on 14:31.

Canaan heard about and believed in this miraculous deliverance, and it terrified them (Josh. 2:9-10; 9:9).

Some critics' problem may be moral rather than intellectual. Some of the critics do not want to deal with the implications of an occurrence of supernatural phenomena, so they try to explain them away. The text clearly presents a supernatural deliverance, and even states that God acted as He did in order to prove His supernatural power (vv. 4, 18).

"From the start of the exodus, it becomes clear, Yahweh has orchestrated the entire sequence."<sup>1</sup>

The LORD finished the Israelites' liberation when He destroyed the Egyptian army. The Israelites' slavery ended when they left Egypt, but they only began to experience true freedom after they crossed the Red Sea. The ten plagues had broken Pharaoh's hold on the Israelites, but the Red Sea deliverance removed them from his reach forever. God redeemed Israel on the Passover night, but He fully liberated Israel from slavery, finally, at the Red Sea.<sup>2</sup> In Christian experience, these two works of God—redemption and liberation—occur at the same time; they are two aspects of the same salvation, two sides of the same coin.

Archaeologists have discovered the mummified remains of Amenhotep II in the Valley of the Tombs of the Kings. Evidently he personally did not lead the Egyptian army into the Red Sea. The biblical text says that he pursued the Israelites, but it does not say that he personally perished in the Red Sea (cf. v. 6). He lived 22 years after this.<sup>3</sup>

### **3. Israel's song of deliverance 15:1-21**

"The song is composed of three gradually increasing strophes, each of which commences with the praise of Jehovah, and ends with a description of the overthrow of the Egyptian host (vv. 2-5, 6-10, 11-18). The theme announced in the introduction in v. 1 is thus treated in three different ways; and whilst the omnipotence of God, displayed in the destruction of the

---

<sup>1</sup>Durham, p. 198.

<sup>2</sup>See William D. Ramey, "The Great Escape (Exodus 14)," *Exegesis and Exposition* 1:1 (Fall 1986):33-42.

<sup>3</sup>L. Wood, *A Survey ...*, p. 134.

enemy, is the prominent topic in the first two strophes, the third depicts with prophetic confidence the fruit of this glorious event in the establishment of Israel, as a kingdom of Jehovah, in the promised inheritance."<sup>1</sup>

"This song as a whole is a textbook example of the divine warrior imagery so prevalent in the Old Testament [cf. Judg. 5; 2 Sam. 22:1-51]."<sup>2</sup>

Cassuto divided the strophes better, I believe, as vv. 1-6, vv. 7-11, and vv. 12-16, with an epilogue in vv. 17-18.<sup>3</sup> Kaiser proposed a similar division: 1b-5, 6-10, 11-16a, and 16b-18.<sup>4</sup>

"It is not comparable to any one psalm, or song or hymn, or liturgy known to us anywhere else in the OT or in ANE [ancient Near Eastern] literature."<sup>5</sup>

"Yahweh is both the subject and the object of this psalm; the hymn is about him and to him, both here and in the similar usage of Judg 5:3 ..."<sup>6</sup>

It is interesting that Moses described the Egyptian pursuers as being "hurled into the sea" (vv. 1, 4), and sinking "like a stone" (v. 5) and "lead" (v. 10). The same image—of God reaching down and tossing each soldier of the Egyptian army into the water, one by one—describes Pharaoh's earlier order to throw the Hebrew babies into the Nile River (1:22). God did to the Egyptians what they had done to the Israelites.<sup>7</sup>

"It is difficult to exaggerate the importance of God's name Yahweh in the Bible ([v. 3; cf.] 3:14, 15). Other supposed gods had secret names that only guilds of priests knew. By knowing a god's secret name, a priest supposedly had special access to

---

<sup>1</sup>Keil and Delitzsch, 2:50.

<sup>2</sup>Enns, p. 298.

<sup>3</sup>Cassuto, 173. See also Jasper J. Burden, "A Stylistic Analysis of Exodus 15:1-21: Theory and Practice," *OTWSA* 29 (1986):34-70.

<sup>4</sup>Kaiser, "Exodus," p. 393-96.

<sup>5</sup>Durham, p. 203.

<sup>6</sup>*Ibid.*, p. 205.

<sup>7</sup>Sailhamer, *The Pentateuch ...*, p. 271.

that god. But the living God has made His name known to all, and salvation is found in His name alone."<sup>1</sup>

This hymn is a fitting climax to all of God's miracles performed on behalf of the Israelites in leading them out of Egypt.<sup>2</sup> It is a song of praise that focuses on God Himself, and attributes to Him the superiority over all other gods that He had demonstrated (cf. v. 11). Undoubtedly the Israelites sang this inspired song many times during their wilderness wanderings, and for generations from then on.<sup>3</sup>

The first part of the song (vv. 1-12) looks back on God's destruction of the Egyptian army, and the second part (vv. 13-18) predicts Israel's entrance into the Promised Land. The divine name appears ten times. "Redeemed" (v. 13) comes from a Hebrew word (*ga'al*) that has to do with protecting family rights. It refers to "the responsibility of a close relative to buy back family land that had been sold because of debt (Lev. 25:25)."<sup>4</sup> This hymn closes by alluding to God's continuing sovereign reign (v. 18).

Miriam was a "prophetess" (v. 20), in that she spoke authoritatively, under divine inspiration, for God and led the Israelites in worship (cf. 1 Chron. 25:1).<sup>5</sup> Other female prophetesses in Israel's history were Deborah (Judg. 4:4), Isaiah's wife (Isa. 8:3), and Huldah (2 Kings 22:14). The New Testament evangelist Philip also had four daughters who prophesied (Acts 21:9).

"The event at the Red Sea, when the Egyptian army was drowned, was celebrated as a great military victory achieved by God (Exodus 15:1-12). It was that event, wherein a new dimension of the nature of God was discovered by the Hebrews (the new understanding is expressed forcefully by the explanation 'the Lord is a man in battle' [v. 3]), that opened to their understanding the real possibility, if not necessity, of

---

<sup>1</sup> *The Nelson ...*, p. 125.

<sup>2</sup> See Richard D. Patterson, "Victory at Sea: Prose and Poetry in Exodus 14—15," *Bibliotheca Sacra* 161:641 (January-March 2004):42-54.

<sup>3</sup> See Jeffrey E. MacLurg, "An Ode to Joy: The Song of the Sea (Exodus 15:1-21)," *Exegesis and Exposition* 1:1 (Fall 1986):43-54.

<sup>4</sup> *The Nelson ...*, p. 126.

<sup>5</sup> See L. Wood, *The Prophets ...*, pp. 140-43.

taking possession of the promised land by means of military conquest (Exodus 15:13-18)."<sup>1</sup>

"The Exodus was one of the foundational events of Israel's religion. It marked the liberation from Egyptian slavery, which in turn made possible the formation of a relationship of covenant between Israel and God. And nowhere is the Exodus given more powerful expression than in the Song of the Sea (Exodus 15:1-18), a great victory hymn celebrating God's triumph over Egypt at the sea. To this day, the ancient hymn continues to be employed in the synagogue worship of Judaism. Its continued use reflects the centrality of its theme, that of God's control over the forces of both nature and history in the redemption of his people.

"When one reads the Song of the Sea, one immediately gains an impression of the joy and exhilaration expressed by those who first used its words in worship. But what is not immediately evident to the modern reader is the subtle manner in which the poet has given force to his themes by the adaptation of Canaanite mythology. Underlying the words and structure of the Hebrew hymn are the motifs of the central mythology of Baal; only when one understands the fashion in which that mythology has been transformed can one go on to perceive the extraordinary significance which the poet attributed to the Exodus from Egypt.

"The poet has applied some of the most central motifs of the myth of Baal. These motifs may be summarized in certain key terms: conflict, order, kingship, and palace-construction. Taking the cycle of Baal texts as a whole (see further Chapter IV), the narrative begins with conflict between Baal and Yamm ('Sea'); Baal, representing order, is threatened by the chaotic Yamm. Baal's conquest of Yamm marks one of the steps in the process of creation; order is established, and chaos is subdued. Baal's victory over Yamm is also the key to his kingship, and to symbolize the order and consolidate the kingship, Baal initiates the construction of his palace. And then, in the course of the myth, conflict breaks out again, this time between Baal

---

<sup>1</sup>Peter C. Craigie, *The Problem of War in the Old Testament*, p. 67.

and Mot. Baal is eventually victorious in this conflict, establishing once again his kingship and the rule of order. It is important to note not only the centrality of these motifs in the Baal myth, but also their significance; the motifs as a whole establish a cosmological framework within which to interpret the Baal myth. It is, above all, a cosmology, developing the origins and permanent establishment of order in the world, as understood and believed by the Canaanites. Its central celebration is that of creation.

"In the Song of the Sea, the poet has developed the same central motifs in the structure of his song. The song begins with conflict between God and Egypt (Exodus 15:1-12), but the way in which the poet has transformed the ancient motifs is instructive. 'Sea' is no longer the adversary of order, but God uses the sea (Hebrew *yam*) as an instrument in the conquest of chaos. After the conquest, God is victorious and establishes order; his kingship is proclaimed in a statement of his incomparability (verse 11). But then the theme of conflict is resumed again, as future enemies are anticipated (verses 14-16). They, too, would be conquered, and eventually God's palace and throne would be established as a symbol of the order achieved in his victory (verse 17). Finally, God's kingship would be openly declared, as a consequence of his victories: 'the Lord shall reign for ever and ever' (verse 18). The Hebrew expression for this statement of kingship is *yhwh ymlk*, directly analogous to the celebration of Baal's kingship in the Ugaritic texts: *b'l ymlk*.

"It is one thing to trace the motifs of the Baal myth in the Song of the Sea; it is another to grasp their significance. The primary significance lies in the cosmological meaning of the motifs; the Hebrew poet has taken the symbolic language of creation and adapted it to give expression to his understanding of the meaning of the Exodus. At one level, the Exodus was simply the escape of Hebrews from Egyptian slavery; at another level, it marked a new act of divine creation. Just as Genesis 1 celebrates the creation of the world, so too Exodus 15 celebrates the creation of a new people, Israel. And when one perceives this underlying significance of the poetic language



employed in the Song of the Sea, one is then in a position to understand better another portion of the biblical text, namely, the reasons given for the observation of the sabbath day."<sup>1</sup>

"Throughout the poem, however, the picture of God's great deeds foreshadows most closely that of David, who defeated the chiefs of Edom, Philistia, and Canaan and made Mount Zion the eternal home for the Lord's sanctuary (v. 17)."<sup>2</sup>

"The poem of Exod 15 celebrates Yahweh present *with* his people and doing *for* them as no other god anywhere and at any time *can* be present to do. As such, it is a kind of summary of the theological base of the whole of the Book of Exodus."<sup>3</sup>

"This song is, by some hundred years, the oldest poem in the world."<sup>4</sup>

Worship was the result of redemption. Though Moses was the Israelites' human leader, it was clear that Yahweh was their "true King" ("The LORD shall reign forever and ever," v. 18). The people looked back at their deliverance, in this worshipful song, and forward to God's Promised Land. At this point, their joy was due to their freedom from slavery. However, the desert lay ahead. The family of Abraham had become a nation, and God was now dwelling among them in the cloud.<sup>5</sup> God's presence with the nation introduced the need for holiness in Israel. The emphasis on holiness began with God's dwelling among His people in the cloud. This divine presence and appreciation of God's holiness increased, when God later descended on the tabernacle and the ark of the covenant.

The parallel that exists between Abraham's experiences and Israel's is also significant. God first called Abram out of pagan Ur. Then He blessed him with a covenant, after the patriarch first obeyed God and went where Yahweh led him. God did the same thing with Israel. This similarity suggests

---

<sup>1</sup>Idem, *Ugarit and the Old Testament*, pp. 88-89. See also Frank M. Cross Jr., "The Song of the Sea and Canaanite Myth," in *God and Christ: Existence and Province*, pp. 1-25.

<sup>2</sup>Sailhamer, *The Pentateuch ...*, p. 272.

<sup>3</sup>Durham, p. 210.

<sup>4</sup>Jamieson, et al., p. 67.

<sup>5</sup>Josephus wrote *Against Apion* partially to refute Apion's assertion that the Jews were originally Egyptians. See *Against Apion*, 2:2, 3.

that God's dealings, with both Abram and Israel, may be programmatic and indicative, generally, of His method of dealing with His elect.

"There is a definite parallel between the supernatural preparation for the kingdom in history under Moses and the supernatural judgments which shall be poured out upon a rebellious world in preparation for the future millennial kingdom of our Lord Jesus Christ at His second advent. There is the same insolent challenge to the true God on the part of the Gentile powers (Ps. 2:1-3). There will be a similar gracious but infinitely greater preliminary miracle—the Rapture of the Church—warning men of the supremacy of Jehovah and the ultimate defeat of all who rebel against Him. There will be the same swift progression in the severity of the divine judgments (cf. Rev. 6 through 18). There will be the same victorious outcome, the destruction of the antichrist and his armies in the judgment of Armageddon, and the deliverance of the people of Israel (Rev. 19). There will be another song of victory, significantly referred to as 'the song of Moses ... and the song of the Lamb' (Rev. 15:1-3)."<sup>1</sup>

## **II. THE ADOPTION OF ISRAEL 15:22—40:38**

The second major section of Exodus records the events associated with God's adoption of Israel as His chosen people. Having redeemed Israel out of slavery in Egypt, the LORD now formally made the nation His privileged "son"—by covenant. Redemption is the end of one journey but the beginning of another.

### **A. GOD'S PREPARATORY INSTRUCTION OF ISRAEL 15:22—18:27**

The events in this section of the text record God's preparation of His people for the revelation of His gracious will for them at Mt. Sinai.

---

<sup>1</sup>McClain, p. 56.

## 1. Events in the wilderness of Shur 15:22-27

15:22-26 The Wilderness of Shur (v. 22) was a section of semi-desert to the east of Egypt's border. It occupied the northwestern part of the Sinai Peninsula, and it separated Egypt from Palestine.

"... wilderness does not imply a waste of sand, but a broad open expanse, which affords pasture enough for a nomad tribe wandering with their flocks. Waste and desolate so far as human habitations are concerned, the traveller [*sic*] will only encounter a few Bedouins. But everywhere the earth is clothed with a thin vegetation, scorched in summer drought, but brightening up, as at the kiss of the Creator, into fair and beautiful pastures, at the rainy season and in the neighbourhood of a spring."<sup>1</sup>

This area has not changed much over the centuries.

Moses had asked Pharaoh's permission for the Israelites to take a three-day journey into the wilderness (3:18; 5:3; 8:27), but now, having traveled three days, the people found no water suitable for drinking. The water at the oasis they reached, later named Marah, was brackish (vv. 23-24). This circumstance caused the people to complain again (cf. 14:11-12). In just three days, they had forgotten God's miracles at the Red Sea, not to mention the plagues. This failure to depend on God should prove that miracles do not result in great faith. Rather, great faith comes from a settled conviction that God is trustworthy.

"When the supply fails, our faith is soon gone."<sup>2</sup>

"... we may in our journey have reached the pools that promised us satisfaction, only to find them brackish. That marriage, that friendship, that new home, that partnership, that fresh avenue of

---

<sup>1</sup>Meyer, p. 178.

<sup>2</sup>Martin Luther, quoted by Keil and Delitzsch, 2:58.

pleasure, which promised so well turns out to be absolutely disappointing. Who has not muttered 'Marah' over some desert well which he strained every nerve to reach, but when reached, it disappointed him!"<sup>1</sup>

"Nothing so thoroughly sifts the heart as disappointment—bright and lofty anticipations suddenly cast to the ground."<sup>2</sup>

Some commentators have seen the tree cast into the water as a type of the cross of Christ or Christ Himself that, applied to the bitter experiences of life, makes them sweet (cf. John 4:10; 6:35). What is definitely clear, is that by using God's specified means and obeying His word, the Israelites learned that God would heal them (v. 25). Throwing the wood into the water did not magically change it, but it did make the miracle easier to perceive. This was a symbolic act, similar to Moses lifting his staff (also wood) over the sea (14:16; cf. 17:9). God changed the water. He is able to turn bitter water into sweet water for His people. We should seek God first when we get sick. God often uses physicians, but He is the Healer.

The words of God in verse 26 explain the "statute and regulation" just given in verse 25. The Israelites would not suffer the "diseases" that God had "put on the Egyptians"—they would not experience His discipline—if they continued to obey His word as they had just done. They had by simply casting the tree into the pool obeyed God. Therefore, they could always count on His help if they continued to obey Him. God's test at Marah involved seeing whether they would rely on Him or not (cf. James 1).

God was teaching His people that He was responsible for their physical—as well as their spiritual—well-being. While doctors diagnose and prescribe, only God can heal.<sup>3</sup>

---

<sup>1</sup>Meyer, p. 181.

<sup>2</sup>Wagner, p. 51.

<sup>3</sup>See Jay D. Fawver and R. Larry Overstreet, "Moses and Preventive Medicine," *Bibliotheca Sacra* 147:587 (July-September):285.

"We do not find Him [God] giving Himself a new name at Elim, but at Marah. The happy experiences of life fail to reveal all the new truth and blessing that await us in God [cf. Gen. 15:1; Exod. 17:15]."<sup>1</sup>

This is one of the verses in Scripture that advocates of the "prosperity gospel" like. They use it to prove their contention that it is never God's will for anyone to be sick (along with 23:25; Ps. 103:3; Prov. 4:20-22; Isa. 33:24; Jer. 30:17; Matt. 4:23; 10:1; Mark 16:16-18; Luke 6:17-19; Acts 5:16 and 10:38). One advocate of this position wrote as follows:

"Don't ever tell anyone sickness is the will of God for us. It isn't! Healing and health are the will of God for mankind. If sickness were the will of God, heaven would be filled with sickness and disease."<sup>2</sup>

15:27 At Elim Israel learned something else about God. Not only would He deliver them (v. 3) and heal them (v. 26), but He would also provide refreshing drink ("twelve springs of water") and nourishing food ("seventy date palms") for them as their Shepherd (cf. Ps. 23:2). Likewise, we should learn to look to God first to provide for our daily needs. God often uses jobs, gifts, and scholarships, but He is the Provider.

Marah, with its bitter waters, intervenes between the triumphant song at the Red Sea, and Elim, with its twelve wells of water. What a picture this of the Christian's life, in which dark hours often follow, and are followed by bright ones!"<sup>3</sup>

"If life were nothing but tests, we would be discouraged. If life were all pleasure, we would never learn discipline and develop character. The

---

<sup>1</sup>Meyer, pp. 183-84.

<sup>2</sup>Kenneth Hagin, *Redeemed from Poverty, Sickness and Death*, p. 16. For a critique of this view, see Ken L. Sarles, "A Theological Evaluation of the Prosperity Gospel," *Bibliotheca Sacra* 143:572 (October-December 1986):329-52.

<sup>3</sup>Wagner, p. 54.

Lord knows how to balance the experiences of life, for He brought His people to Elim where they found plenty of water and opportunity for rest. Let's be grateful that the Lord gives us enough blessings to encourage us and enough burdens to humble us, and that He knows how much we can take."<sup>1</sup>

One method of God's dealing with the Israelites as His people, that He frequently employed, stands out clearly in these incidents. God did not lead the Israelites around every difficulty. Instead He led them into many difficulties, but He also provided deliverance for them in their difficulties. This caused the Israelites to learn to look to Him for the supply of their needs. He still deals with His children the same way.<sup>2</sup>

## 2. Quails and manna in the wilderness of Sin ch. 16

This chapter records another crisis in the experience of the Israelites, as they journeyed from Goshen to Mt. Sinai, that God permitted and used to teach them important lessons.

16:1-3 The "wilderness of Sin" (v. 1) evidently lay in the southwestern part of the Sinai peninsula. Its name relates to "Sinai," the name of the mountain range located on its eastern edge. Aharoni believed that Paran was the original name of the entire Sinai Peninsula.<sup>3</sup>

This was Israel's third occasion of grumbling (v. 2; cf. 14:11-12; 15:24). The reason this time was not fear of the Egyptian army or lack of water, but lack of food (v. 3).

"Whenever we are tempted to murmur, there are always two things at least that we forget. First we forget what we deserve at the hands of God,— nothing but punishment; and then we forget all

---

<sup>1</sup>Wiersbe, p. 209.

<sup>2</sup>See Allen P. Ross, "When God Gives His People Bitter Water (Exodus 15:22-27)," *Exegesis and Exposition* 1:1 (Fall 1986):55-66.

<sup>3</sup>Y. Aharoni, "Kadesh-Barnea and Mount Sinai," in *God's Wilderness: Discoveries in Sinai*, pp. 165-70.

the mercy and love which He has shewn [*sic*] us in His acts and His promises."<sup>1</sup>

"A pattern is thus established here that continues throughout the narratives of Israel's sojourn in the wilderness. As the people's trust in the Lord and in Moses waned in the wilderness, the need grew for stricter lessons."<sup>2</sup>

16:4-12 God's purpose was to "test" the Israelites (v. 4): to prove what they were, not to tempt them to sin (cf. 15:25; 20:20).

"Godliness isn't the automatic result of reading books and attending meetings; it also involves bearing burdens, fighting battles, and feeling pain."<sup>3</sup>

One manifestation of God's glory was His regular provision of manna, that began the next day and continued for 40 years. The "glory of the LORD" here was the evidence of His presence "in the cloud" (v. 10). This was perhaps a flash of light and possibly thunder, both of which later emanated from the cloud over Mt. Sinai (cf. 19:18).<sup>4</sup>

16:13-21 "These [quail still] fly in such dense masses that the Arab boys often kill two or three at a time, by merely striking at them with a stick as they fly. ... But in spring the quails also come northwards in immense masses from the interior of Africa, and return in autumn, when they sometimes arrive so exhausted, that they can be caught with the hand ..."<sup>5</sup>

Egyptian art pictures people catching the birds in hand nets.<sup>6</sup>

---

<sup>1</sup>Wagner, p. 58.

<sup>2</sup>Sailhamer, *The Pentateuch ...*, p. 273.

<sup>3</sup>Wiersbe, p. 209.

<sup>4</sup>See J. Dwight Pentecost, *The Glory of God*, for how God has and will manifest His glory.

<sup>5</sup>Keil and Delitzsch, 2:66-67.

<sup>6</sup>Hannah, p. 134.

The Hebrew word *man*, translated into Greek as *manna*, and transliterated from Greek into the English word *manna*, is an interrogative particle that means: What? The Greek word *manna* means grain or bread. From this has come the idea that the manna was similar to bread (cf. Ps. 105:40). An omer is about two quarts dry measure (v. 16). The omer is mentioned only in this chapter in the Bible.

Jesus Christ compared Himself to the manna (John 6:32-33, 35, 47-51, 53-58), so it is a type (a divinely intended illustration) of Christ. Our Lord gave Himself unreservedly, but each Christian has no more of Him experientially than he or she appropriates by faith. And when appropriated properly, He proves totally satisfying.

"The manna was Israel's only food during forty years in the wilderness. Christ is the only food of our souls during our journey towards our promised rest; nothing else can nourish them—nothing else can sustain spiritual life, or enable us to put forth spiritual strength."<sup>1</sup>

"It is in the early morning, before the occupations of the day commence, that the gentle dew of the Spirit, and with it the bread of life, descends. It is early in the morning, brethren, that we must go out to gather it. There is no time for gathering so good as that [cf. Ps. 5:3]."<sup>2</sup>

Manna also represents Christ in His humiliation, in the giving of His flesh so that we might have life (John 6:49-51). To meditate on Him is to feed on the "living bread" (John 6:51).

Students of Exodus have explained verse 18 in various ways. Some old Jewish commentators said it describes what happened when each family had finished collecting the manna, and had gathered in their tent to pool their individual amounts. Each time they did this, they discovered that they had

---

<sup>1</sup>Wagner, p. 61.

<sup>2</sup>Ibid., p. 63.



collected just the right amount for their needs. Some Christian commentators have suggested that the Israelites gathered all the manna each day in one central place, and from there each family took as needed. There was always enough for everyone. The former explanation seems to fit the context better.

16:22-30 The Israelites had not yet observed the Sabbath (v. 23) before now. As slaves in Egypt, they had probably worked seven days a week. However, God was blessing them with a day of rest, and was now preparing them for the giving of the fourth commandment (20:8-11). This is the first reference to the Sabbath as such in Scripture: "'See, the LORD has given you the Sabbath; ... Remain, everyone, in his place; no one is to leave his place on the seventh day.' So the people rested on the seventh day." (vv. 29-30).<sup>1</sup>

16:31-36 Evangelical commentators generally have felt that the manna was a substance unique from any other edible food (v. 31). Some interpreters believe it was the sap-like secretion of the tamarisk tree, or the secretion of certain insects common in the desert.<sup>2</sup> In the latter case, the miracle would have been the timing with which God provided it, as well as the abundance of it. Normally this sap only flows in the summer months. If this is the explanation, it was a miracle similar to the plagues, a not totally unknown phenomenon, but divinely scheduled and reinforced. Even though there are similarities between these secretions and the manna, the differences are more numerous—and point to a unique provision.<sup>3</sup>

Josephus wrote that "even now, in all that place, this manna comes down in rain ..." <sup>4</sup> But Joshua 5:12 says that the manna "ceased" just before the Israelites crossed the Jordan River and entered the Promised Land. Josephus, inconsistently, agreed with this fact, in his comment on Joshua 5:12.<sup>5</sup>

---

<sup>1</sup>See Lewis S. Chafer, *Grace*, pp. 183-220, for a full discussion of the Sabbath.

<sup>2</sup>E.g., F. S. Bodenheimer, "The Manna of Sinai," *Biblical Archaeologist* 10:1 (February 1947):2-6; John Gray, *Joshua, Judges, Ruth*, p. 78.

<sup>3</sup>Cf. Ellison, pp. 89-90; Davis, pp. 181-83; *The Nelson ...*, p. 128; Jamieson, et al., p. 119.

<sup>4</sup>Josephus, *Antiquities of ...*, 3:1:6.

<sup>5</sup>*Ibid.*, 5:1:4.

"They [the Israelites] probably published *Mother Moses' Cookbook* with 1001 [manna] recipes."<sup>1</sup>

The Testimony (v. 34, or "covenant" NRSV, or "covenant law" TNIV) refers to the tablets of the Mosaic Law that Aaron later kept in the ark of the covenant (cf. 25:16). Moses told Aaron to "Take a jar and put a full omer of manna in it" before the LORD's presence (i.e., in the ark) "to be kept safe throughout your generations" (vv. 33-34; cf. Num. 17:10-11).<sup>2</sup> These physical objects memorialized God's faithful provision of both spiritual and physical foods (cf. Deut. 8:3). Aaron obeyed this command later: when the Tabernacle was constructed (cf. 40:20).

The Israelites were not completely separate from other people during their years in the wilderness. As they traveled from place to place, they would meet travelers and settlements of nomadic or local tribes from time to time. They evidently traded with these people (cf. Deut. 2:6-7). Consequently their total diet was not just manna, milk, and a little meat, though manna was their most staple commodity.<sup>3</sup>

God sought to impress major lessons on all of His people through the events recorded in this chapter. These included His ability and willingness to provide regularly for their daily needs, and His desire that they experience His blessing. He gave them Sabbath rest to refresh and strengthen their spirits, as well as ample, palatable food for their bodies: manna in the mornings and quail in the evenings. God still provides for His people in both extraordinary (manna) and ordinary (quail) ways. We should not limit Him by refusing to accept His provisions—however He may provide for our needs.

While I was going through seminary, God provided for many of my classmates by sending them unexpected checks in the mail. He never did this for me, as far as I recall, though the first four automobiles I owned were gifts to me. He is infinitely creative in His giving. The Israelites learned this lesson early in their sojourn from Egypt to the Promised Land.

---

<sup>1</sup>McGee, 1:254.

<sup>2</sup>See Sailhamer, *The Pentateuch ...*, pp. 274-75.

<sup>3</sup>See Itzhaq Beit-Arieh, "Fifteen Years in Sinai," *Biblical Archaeology Review* 10:4 (July-August 1984):28-54.

### 3. The lack of water at Rephidim 17:1-7

Again the Israelites complained, this time because there was no water to drink when they camped at Rephidim (cf. 15:24). At Marah there was bad water, but now there was none.

"... the supreme calamity of desert travellers [*sic*] befell them—complete lack of water."<sup>1</sup>

"Every difficulty God permits us to encounter will become either a test that can make us better or a temptation that can make us worse, and *it's our own attitude that determines which it will be.*"<sup>2</sup>

Rephidim was near the wilderness of Sin (v. 1; cf. 19:2; Num. 33:15) and the Horeb (Sinai) range of mountains (v. 6). Israel made at least two stops between the wilderness of Sin and Rephidim: Dophkah and Alush (Num. 33:12-14), but Moses did not record anything that happened there.

The Israelites' grumbling demonstrated lack of faith, since God had demonstrated repeatedly that He would supply their needs. They wanted Him to act as they dictated, rather than waiting for Him to provide as He saw fit. This was how they tested or challenged the LORD (cf. 1 Cor. 10:10). It was proper for God to test them (15:25; 16:4), but it was improper for them to test Him, in the sense of trying His patience. Nevertheless, they attacked Moses in their anger (v. 3).

"Here, then, brethren, we see the danger and the sure result of trusting in man [cf. 1 Cor. 1:12]."<sup>3</sup>

"One of Moses' most characteristic and praiseworthy traits was that he took his difficulties to the Lord (v. 4; 15:25; 32:30; 33:8; Num 11:2, 11; 12:13; 14:13-19 et al.)."<sup>4</sup>

By using his staff (v. 5), Moses showed that God was still enabling him to perform miracles, as he had done in Egypt. He still had divine regal authority, and the power of God was still with him. The elders of Israel

---

<sup>1</sup>Cassuto, p. 201.

<sup>2</sup>Wiersbe, pp. 212-13.

<sup>3</sup>Wagner, p. 69.

<sup>4</sup>Kaiser, "Exodus," p. 406.

apparently accompanied Moses, since they represented the people, and since the whole nation could not get close enough to witness the miracle.

"Horeb" may refer to the mountain range at the southern tip of the Sinai Peninsula (v. 6; cf. 3:1; Deut. 1:2; 1 Kings 19:8). Mt. Sinai may be the name of a particular mountain in that range. This mountain range is the traditional site of Mt Sinai, but other Scriptures make this site questionable (cf. Deut. 33:2; Gal. 4:25). Wherever the Horeb range may have been, Moses struck "the rock at Horeb" (v. 6) somewhere near Mt. Sinai.<sup>1</sup>

"The striking of the rock pictured the coming death of the Savior. Water to satisfy the people's thirst came from the rock that was struck. One day, living water to satisfy spiritual thirst would come from the death of Jesus, our Rock [cf. Deut. 32:30-31, 37; Isa. 53:10; Zech. 13:7; John 4:10, 14; 7:37; 1 Cor. 10:4]."<sup>2</sup>

How could water flowing out of a rock satisfy the thirst of millions of Israelites? Perhaps the water flowed into a bowl-like depression and created a reservoir, from which such a vast crowd could obtain enough water to satisfy them.

Massah (v. 7) means "testing" or "proof," and Meribah means "murmuring," "dissatisfaction," or "contention." The first name, Massah, commemorated the Israelites' testing of God, and the second name, Meribah, their quarreling with Moses. They failed to believe that the LORD was among them as He had promised He would be. Except for Joshua 9:18 and Psalm 59:15, all the other references to grumbling in the Old Testament occur in six chapters of the Pentateuch: Exodus 15, 16, 17, and Numbers 14, 16, and 17.<sup>3</sup>

"In our own time the same demand is made, the same challenge repeated. Men are not satisfied with the moral evidences of the Being and providence of God, they point to the physical evils around, the hunger and thirst, the poverty and misery, the pollution and self-will of our times, crying—If there be a God, why does He permit these things? Why does

---

<sup>1</sup>See Aviram Perevolotsky and Israel Finkelstein, "The Southern Sinai Exodus Route in Ecological Perspective," *Biblical Archaeology Review* 11:4 (July-August 1985):26-41.

<sup>2</sup>*The Nelson ...*, p. 130.

<sup>3</sup>Kaiser, "Exodus," p. 398.

He allow suffering and sorrow? Why does He not interpose? And then, when the heavens are still silent, they infer that there is no God, that the sky is an empty eye-socket, and that there is nothing better than to eat and drink, because death is an eternal sleep."<sup>1</sup>

God had assured the Israelites in Egypt that He would bring them into the Promised Land (3:8, 17; 13:5, 11). Consequently all their grumbling demonstrated lack of faith. This second instance of complaining about lack of water was more serious than the first, because God had previously provided good water for them in the desert (15:25).

#### **4. The hostility of the Amalekites 17:8-16**

Whereas the Israelites had feared the possibility of having to battle the Egyptians (14:10), they now actually did engage in battle with the Amalekites.

As with all of Israel's experiences after leaving the Red Sea, and before arriving at Mt. Sinai, God was using this encounter to teach the Israelites how they were to live as His chosen people. They were not to expect God to continue to operate as He had during the plagues but were to trust and obey Him on the basis of all His previous revelations to them. God did not deal with the Amalekites as He had dealt with the Egyptians.

"The primary function of this section in its present location is the demonstration of yet another proof and benefit of Yahweh's Presence with Israel. The occasion for the demonstration this time is an attack from the outside instead of an internal complaint. The result, however, is once again an undeniable supernatural intervention of Yahweh. ... Yahweh is present, when the need arises, to fight alongside and even on behalf of his people."<sup>2</sup>

George Wagner saw many parallels between Israel's experiences from Egypt to the Promised Land and the Christian's experiences. At this point he

---

<sup>1</sup>Meyer, p. 196.

<sup>2</sup>Durham, p. 234.

noted that Amalek's opposition to Israel is similar to the flesh's opposition to the Christian.<sup>1</sup>

17:8-13 Moses used the name Amalek to represent the Amalekites, as he often used the name Israel for the Israelites (v. 8). The Amalekites were a tribe of Semites. They were descendants of Esau (Gen. 36:12), and had moved into the part of Sinai that the Israelites now occupied. They also inhabited an area in southern Canaan (cf. Gen. 14:7). They evidently confronted Israel in battle because they felt that Israel was a threat to their security. Josephus called the Amalekites "... the most warlike of the nations that lived thereabout ..."<sup>2</sup>

This is the first biblical reference to Joshua (v. 9). Moses selected him to lead Israel's army of warriors. Moses' staff was the means God used to accomplish miracles for Israel, and to identify those miracles as coming from Himself (cf. v. 5, et al.).

Hur was apparently the son of Caleb (1 Chron. 2:19). This Caleb was not the well-known Caleb of later fame in the Books of Numbers and Joshua. Hur was possibly the grandfather of Bezalel, the architect of the tabernacle (31:2, et al.). Josephus said Hur was the husband of Miriam.<sup>3</sup> In any case, Hur was an important man in Israel (cf. 24:14).

"Moses went to the top of the hill that he might see the battle from thence. He took Aaron and Hur with him, not as adjutants to convey his orders to Joshua and the army engaged, but to support him in his own part in connection with the conflict. This was to hold up his hand with the staff of God in it. To understand the meaning of this sign, it must be borne in mind that, although ver. 11 merely speaks of the raising and dropping of the hand (in the singular), yet, according to ver. 12, both hands were supported by Aaron and Hur, who stood one on either side, so that Moses did

---

<sup>1</sup>Wagner, pp. 77-86.

<sup>2</sup>Josephus, *Antiquities of ...*, 3:2:1.

<sup>3</sup>*Ibid.*, 3:2:4.

not hold up his hands alternately, but grasped the staff with both his hands, and held it up with the two."<sup>1</sup>

"Moses lifted his hands, in symbol of the power of Yahweh upon the fighting men of Israel, surely, but in some miraculous way Moses' upraised hands became also conductors of that power."<sup>2</sup>

Moses' actions suggest that he was engaging in intercessory prayer, although any reference to prayer is absent in the text. The emphasis is on the staff that Moses held in his hand, the instrument of God's power.

"The lifting up of the hands has been regarded almost with unvarying unanimity by Targumists, Rabbins, Fathers, Reformers, and nearly all the more modern commentators, as the sign or attitude of prayer. ... The lifting up of the staff secured to the warriors the strength needed to obtain the victory, from the fact that by means of the staff Moses brought down this strength from above, i.e., from the Almighty God in heaven; not indeed by a merely spiritless and unthinking elevation of the staff, but by the power of his prayer, which was embodied in the lifting up of his hands with the staff, and was so far strengthened thereby, that God had chosen and already employed this staff as the medium of the saving manifestation of His almighty power. There is no other way in which we can explain the effect produced upon the battle by the raising and dropping ... of the staff in his hands. ... God had not promised him miraculous help for the conflict with the Amalekites, and for this reason he lifted up his hands with the staff in prayer to God, that he might thereby secure the assistance of Jehovah for His struggling people. At length he

---

<sup>1</sup>Keil and Delitzsch, 2:79.

<sup>2</sup>Durham, p. 236.

became exhausted, and with the falling of his hands and the staff he held, the flow of divine power ceased, so that it was necessary to support his arms, that they might be kept firmly directed upwards ... until the enemy was entirely subdued."<sup>1</sup>

"The significance of this is that Israel's strength lay only in a continuous appeal to the Lord's power and a continuous remembrance of what He had already done for them ..."<sup>2</sup>

"We see here, then brethren, the beautiful combination of active energy with prayer. One part of Israel is fighting, the other is praying—both at the same time. Which, it might be asked, gained the victory? Both contributed towards it. To have prayed alone without fighting would have been presumption. To have fought without prayer would have been still worse; it would have been self-dependence. It is easy, however, to see which contributed most towards the victory. Which was felt to be the most important? It was prayer."<sup>3</sup>

"Not everybody can be a Moses or Joshua, a D. L. Moody or Billy Graham, but all Christians can be like Aaron and Hur and help hold their hands as they obey God."<sup>4</sup>

Less prominent members of the body of Christ can and should sustain those who are more prominent.

"Why do you fail in your Christian life? Because you have ceased to pray! Why does that young Christian prevail? Ah, in the first place, he prays for himself; but also, there are those in distant places, mothers, sisters, grandparents, who would

---

<sup>1</sup>Keil and Delitzsch, 2:79-81.

<sup>2</sup>Gispen, p. 169.

<sup>3</sup>Wagner, p. 82.

<sup>4</sup>Wiersbe, pp. 214-15.



think that they sinned, if they ceased to pray for him, and they will not fail to lift up their hands for him until the going down of the sun of their lives!"<sup>1</sup>

This battle was more important than may appear on the surface:

"As the heathen world was now commencing its conflict with the people of God in the persons of the Amalekites, and the prototype of the heathen world, with its hostility to God, was opposing the nation of the Lord, that had been redeemed from the bondage of Egypt and was on its way to Canaan, to contest its entrance into the promised inheritance; so the battle which Israel fought with this foe possessed a typical significance in relation to all the future history of Israel. It could not conquer by the sword alone, but could only gain the victory by the power of God, coming down from on high, and obtained through prayer and those means of grace with which it had been entrusted."<sup>2</sup>

What was the immediate significance of this battle for Israel? Israel learned that God would give them victory over their enemies as they relied on Him (cf. John 15:5). He was their Victor, their Champion.

"Jehovah used the attack of Amalek on Israel, at the very beginning of their national history, to demonstrate to His chosen people the potency of intercession. The event reveals a mighty means of strength and victory which God has graciously afforded His people of all ages."<sup>3</sup>

---

<sup>1</sup>Meyer, p. 202.

<sup>2</sup>Keil and Delitzsch, 2:81. Cf. Zech. 4:6; John 15:5.

<sup>3</sup>D. Edmond Hiebert, *Working with God: Scriptural Studies in Intercession*, p. 57. All of chapter 5 of this excellent book deals with Exodus 17:8-16.

Josephus wrote that no Hebrews died in this battle, but innumerable Amalekites perished.<sup>1</sup> However, the Bible does not substantiate his claim.

17:14-16 This is the first of five instances in the Pentateuch where we read that Moses wrote down something at the LORD's command: "Write this in a book as a memorial." (v. 14; cf. 24:4, 7; 34:27; Num. 33:1-2; Deut. 31:9, 24).<sup>2</sup> Clearly Moses could write, which some critics of the Bible have questioned.

God promised the eventual destruction of the Amalekites in order to strengthen Moses' faith in God's help against all of Israel's enemies (v. 14). Later, God commanded the Israelites to exterminate the Amalekites after they conquered Canaan (Deut. 25:19). The Bible mentions the Amalekites for the last time in 1 Chronicles 4:43, when a remnant of them perished in Hezekiah's day. Some commentators have identified Haman, called an Agagite in the Book of Esther, with the Amalekites.<sup>3</sup> "Agag" was evidently an Amalekite name or title (cf. 1 Sam. 15:32-33). There is serious question, however, whether Haman was a descendant of the Amalekites, as some of the better commentaries on Esther point out.

The altar that Moses built (v. 15) commemorated God's victory, as well as His self-revelation as the One who would provide victory for Israel against her enemies. The "banner" was a flag that the victor could raise over his defeated foe. "The LORD is My Banner" was the name of the altar, not a name for God. The altar was used to worship Yahweh, whom Moses now identified with this symbol of Israel's victory.

"The sight of Moses so blessing Israel and judging Amalek would symbolize Yahweh, by whom all blessing and all cursing were believed to be empowered; thus the altar was named not 'Moses

---

<sup>1</sup>Josephus, *Antiquities of ...*, 3:2:5.

<sup>2</sup>Kaiser, "Exodus," p. 409.

<sup>3</sup>E.g., Hyatt, p. 183.

is my standard,' or 'The staff of Elohim is my standard,' but 'Yahweh is my standard.'"<sup>1</sup>

God set Himself against (predetermined the destruction of) the Amalekites because they set themselves against His people and His purposes through them (v. 16).<sup>2</sup>

"The battle between Yahweh and Amalek will continue across the generations because the Amalekites have raised a hand against Yahweh's throne, that is, they have challenged his sovereignty by attacking his people."<sup>3</sup>

"In Amalek the heathen world commenced that conflict with the people of God, which, while it aims at their destruction, can only be terminated by the complete annihilation of the ungodly powers of the world. ... Whereas he [Moses] had performed all the miracles in Egypt and on the journey by stretching out his staff, on this occasion he directed his servant Joshua to choose men for the war, and to fight the battle with the sword. He himself went with Aaron and Hur to the summit of a hill to hold up the staff of God in his hands, that he might procure success to the warriors through the spiritual weapons [*sic* weapon] of prayer."<sup>4</sup>

"I am convinced beyond any doubt that virtually all advances for Christ come because of believers who understand and practice prayer."<sup>5</sup>

In all the various crises the Israelites had faced since they left Egypt, God was teaching them to look to Him. They should look to Him for deliverance from their enemies (at the Red Sea), for health and healing (at Marah), and

---

<sup>1</sup>Durham, p. 237.

<sup>2</sup>On God's use of war against His enemies, see Craigie, *The Problem ...*, and John Wenham, *The Goodness of God*.

<sup>3</sup>Durham, p. 237.

<sup>4</sup>Keil and Delitzsch, 2:78.

<sup>5</sup>R. Kent Hughes, *Living on the Cutting Edge*, p.11.

for food and guidance (in the wilderness of Sin). They should also look to Him for water and refreshment (at Massah-Meribah), and for victory over their enemies in battle (at Rephidim). He was teaching them how dependent they were on Him, and that they should turn to Him in any and every need (cf. John 15:5).

Much of the grumbling, distress, and failure that the Israelites experienced later came on them because they forgot these basic lessons. God had promised to meet their needs, and had done so faithfully in the past. Likewise, Christians get into trouble when we forget these basic lessons. God Himself is a sufficient resource for His people.

"The present narrative in Exodus 17 appears to have been shaped by its relationship to the events recorded in Numbers 21:1-3, the destruction of Arad. The two narratives are conspicuously similar. Here in Exodus 17, the people murmured over lack of water and Moses gave them water from the rock (vv. 1-7). They were attacked by the Amalekites but went on to defeat them miraculously while Moses held up his hands (in prayer?). So also in the narrative in Numbers 21, after an account of Israel's murmuring and of getting water from the rock (20:1-13), Israel was attacked but miraculously went on to defeat the Canaanites because of Israel's vow, which the narrative gives in the form of a prayer (21:1-3). ... The parallels between the two narratives suggest an intentional identification of the Amalekites in the Exodus narratives and the Canaanites in Numbers 21:1-3."<sup>1</sup>

Sailhamer charted the parallel literary structures of the two incidents, similar to what follows:

- A     Manna and quail (Exod. 16:4-34)
- B     40 years (Exod. 16:35)
- C     Water from the rock (Exod. 17:1-7)
- D     Joshua, the next leader (Exod. 17:8-13)

---

<sup>1</sup>Sailhamer, *The Pentateuch ...*, pp. 279-80. Paragraph division omitted.

- E Battle with the Amalekites (Exod. 17:14-16)
- A' Manna and quail (Num. 11:4-34)
- B' 40 years (Num. 14:21-22)
- C' Water from the rock (Num. 20:1-12)
- D' Eleazar, the next priest (Num. 20:23-29)
- E' Battle with the Canaanites (Num. 21:1-16)<sup>1</sup>

### 5. The friendliness of Jethro the Midianite ch. 18

As a Midianite, Jethro was a descendant of Abraham, as was Amalek. Therefore both were blood relatives of the Israelites. Nevertheless the attitudes of the Amalekites and Jethro were very different, although Midian as a nation was hostile to Israel. Set next to each other in the text, as they are, the experiences of Israel with Amalek and with Jethro illustrate two different attitudes that other individuals and groups have also held toward Israel. These differences have characterized the attitudes of outsiders toward God's elect throughout history.<sup>2</sup>

18:1-12 The names of Moses' sons (Gershom and Eliezer, vv. 3-4) reflect his personal experiences in the providence of God. However, not all biblical names carry such significance.

"It is a very precarious procedure to attempt to analyze the character or disposition of an Old Testament character on the basis of the etymology of his name alone."<sup>3</sup>

Many names were significant (e.g., Abraham, Isaac, Jacob, Israel, etc.), but not all were.

"The mountain of God" (v. 5) is the mountain where God revealed Himself and His law to Israel: Mt. Sinai. "The wilderness" was the wilderness near Sinai.

---

<sup>1</sup>Adapted from *ibid.*, p. 278.

<sup>2</sup>Cf. Kaiser, "Exodus," p. 408.

<sup>3</sup>Davis, p. 187.

"Moses' summary [vv. 8-10] is a proof-of-Presence summary, a confession of Yahweh's powerful protection of and provision for Israel."<sup>1</sup>

Jethro acknowledged the sovereignty of God ("the LORD is greater than all the gods," v. 11). This does not prove he was a monotheist, though he could have been. Jethro was a God-fearing man, and evidently part of a believing minority in Midian. He gave evidence of his faith by offering a burnt offering and by making sacrifices for God (v. 12). The meal that Moses, Aaron, and the Israelite elders ate with Jethro was the sacrificial meal just mentioned. Eating together in the ancient Near East was a solemn occasion, because it constituted the establishment of an alliance, pact, or treaty, between the parties involved. That is undoubtedly what it involved here. The fact that Aaron and all the elders of Israel were also present demonstrated its importance.

18:13-23 Moses was attempting to judge and settle all the disputes in Israel, and was beginning to experience a crisis of overwork (cf. Acts 6:1-7). Previously he had had to cope with a lack of food and a lack of water. This section explains how he overcame the present crisis. It also explains the beginning of Israel's legal/justice system. Here we see how the requirements and instructions of the Mosaic Covenant became accessible to the ordinary Israelite, and applicable to the problems that arose as the Israelites oriented their lives to that code.<sup>2</sup>

Clearly, Israel already at this time had a body of revealed law (v. 16; cf. 15:26). I shall say more about older ancient Near Eastern law codes in my comments on 21:1—23:19. God greatly expanded this with the giving of the Mosaic Covenant.

Evidently the people were becoming unruly, because Moses was not dispensing justice quickly enough. His situation was more stressful than he could manage (v. 23). Jethro's counsel was wise and practical, and he presented it as a suggestion, subject to the will of God ("If ... God so commands you," v.

---

<sup>1</sup>Durham, p. 244.

<sup>2</sup>Ibid., p. 248.

23). Sometimes God leads believers through the counsel of wise, qualified, trustworthy people.<sup>1</sup>

"He [Jethro] comes into the camp like a breeze of common sense."<sup>2</sup>

Moses may not have realized the seriousness of the problem he faced. He seems to have been a gifted administrator, who would not have consciously allowed Israel's social welfare to deteriorate. However, his "efficiency expert" father-in-law pointed out how he could manage his time better.

"The fact that Moses acted on Jethro's advice is almost certain evidence that he recognized that God was speaking to him through this man."<sup>3</sup>

Sometimes, when we labor under great stress, we need to reorganize our activities and time, and delegate some of our responsibilities.

Notice the importance of integrity in verse 21. Integrity means matching walk with talk, practicing what one preaches. This has always been an important qualification for leaders.

"Mr. [Dwight L.] Moody said shrewdly: It is better to set a hundred men to work, than do the work of a hundred men. You do a service to a man when you evoke his latent faculty. It is no kindness to others or service to God to do more than your share in the sacred duties of Church life."<sup>4</sup>

18:24-27 Moses allowed the people to nominate wise, respected men of integrity from their tribes, whom he appointed as judges (cf. Deut. 1:12-18). These men handled the routine disputes of the Israelites, and this kept Moses free to resolve the major problems.

---

<sup>1</sup>See Charles R. Swindoll, *The Mystery of God's Will*, pp.48-49.

<sup>2</sup>E. M. Blaiklock, *Today's Handbook of Bible Characters*, p. 71.

<sup>3</sup>G. Campbell Morgan, *An Exposition of the Whole Bible*, p. 41. See McGee, 1:260-61, for the view that Jethro's suggestion was not God's will.

<sup>4</sup>Meyer, p. 210.

Jethro returned to his native land (v. 27), but he later visited Moses and his daughter and grandchildren again (cf. Num. 10:29), and perhaps at other times during the following 40 years.

"In times of great crises God always provided men to lead the way to deliverance. Moses is an eloquent example of this very fact. The hand of God providentially prepared this man for this very moment. He was cognizant of Egyptian manners and was therefore able to articulate demands before the King of Egypt. Moses had been trained in military matters and was therefore capable of organizing this large mass of people for movement across the deserts. His training in Egypt had given him the ability to write and therefore provided a means by which these accounts would be recorded for eternity. Forty years of desert experience had given Moses the know-how of travel in these areas as well as the kind of preparation that would be needed to survive the desert heat. All of this a mere accident of history? No indeed. The history before us is a supreme example of God's sovereign ability to accomplish His purposes for His people. Those who belong to Him have every reason to be confident that that which God has promised He will perform."<sup>1</sup>

"The present narrative has many parallels with the accounts in Genesis 14 and 15. Just as Melchizedek the priest of Salem (*salem*) met Abraham bearing gifts as he returned from the battle with Amraphel (Ge 14:18-20), so Jethro the Midianite priest came out with Moses' wife and sons to offer peace (*salom*, 18:7; NIV 'they greeted each other') as he returned from the battle with the Amalekites. ... The purpose of these parallels appears to be to cast Jethro as another Melchizedek, the paradigm of the righteous Gentile. It is important that Jethro have such credentials because he plays a major role in

---

<sup>1</sup>Davis, pp. 189-90.



this chapter, instructing Moses, the lawgiver himself, how to carry out the administration of God's Law to Israel. Thus, just as Abraham was met by Melchizedek the priest (Ge 14) before God made a covenant with him in Genesis 15, so Moses is met by Jethro the priest (Ex 18) before God makes a covenant with him at Sinai (Ex 19)."<sup>1</sup>

<b>Melchizedek (Gen. 14:17-24)</b>	<b>Jethro (Exod. 18:1-27)</b>
He was a Gentile priest of Salem (Gen. 14:18).	He was a Gentile priest of Midian (Exod. 18:1).
He met Abraham bearing gifts as Abraham returned from defeating the Mesopotamians (Gen. 14:18).	He met Moses as Moses returned from defeating the Amalekites (Exod. 18:5).
He brought gifts to Abraham (Gen. 14:18).	He brought Moses' wife and sons to Moses (Exod. 18:2-6).
He was king of peace (Heb. <i>salem</i> , Gen. 14:18).	He offered Moses peace (Heb. <i>salom</i> , Exod. 18:7).
Abraham's heir was Eliezer ("God is my help," Gen. 15:2).	Moses' heir was Eliezer ("God is my help," Exod. 18:4).
Melchizedek praised God for rescuing Abraham from the Amalekites (Gen. 14:19-20).	Jethro praised God for rescuing Moses from the Egyptians (Exod. 18:10-11).
He offered bread and wine (Gen. 14:18).	He offered sacrifices and ate bread with Moses (Exod. 18:12).

In summary, Moses recorded seven experiences that the Israelites had as they traveled between the Red Sea and Mount Sinai:

1. They praised God with the Song of Moses at the Red Sea (15:1-21).

<sup>1</sup>Sailhamer, *The Pentateuch ...*, pp. 280-81.

2. They found no good water at Marah in the wilderness of Shur (15:22-26).
3. They found food and drink at Elim (15:27).
4. God provided manna and quails in the wilderness of Sin (16:1-36).
5. They found no water at Rephidim (17:1-7).
6. They defeated Amalek in battle at Rephidim (17:8-16).
7. Jethro advised Moses at Mt. Sinai (18:1-27).

### **B. THE ESTABLISHMENT OF THE MOSAIC COVENANT 19:1—24:11**

The LORD had liberated Israel from bondage in Egypt, but now He adopted the nation into a special relationship with Himself.

"Now begins the most sublime section in the whole Book. The theme of this section is supremely significant, playing a role of decisive importance in the history of Israel and of humanity as a whole."<sup>1</sup>

At Sinai, Israel received the Law and the tabernacle. The Law facilitated the obedience of God's redeemed people, and the tabernacle facilitated their worship. Thus the Law and the tabernacle deal with the two major expressions of the faith of the people redeemed by the grace and power of God: obedience and worship.

Here begins the fifth dispensation, the dispensation of the Law. It ended with the death of Christ, who alone fulfilled all of its requirements and, as a second Moses, superseded it with His own teaching. God gave the Israelites the law because of their sinfulness, which we have seen they committed after their redemption. The Apostle Paul wrote: "Why the Law then? It was added on account of the violations ... until the Seed would come to whom the promise had been made" (Gal. 3:19). The law taught the wayward Israelites, and teaches all readers of this history, the awesome holiness of God (19:10-25) and the exceeding sinfulness of man (Rom. 7:13; 1 Tim. 1:8-10). It also taught and teaches the necessity of obedience (Jer. 7:23-24), the universality of human failure (Rom. 3:19-20, 23), and

---

<sup>1</sup>Cassuto, p. 223.

the marvel of God's grace, which provided a way whereby redeemed sinners could have ongoing relationship with a holy God (Rom. 3:21-22).

The Law did not change the provisions of, or abrogate the promises that God gave in, the Abrahamic Covenant. God did not give it as a means of justification for unbelievers (Acts 15:10-11; Gal. 2:16, 21; 3:3-9, 14, 17, 24-25), but as a means of sanctification, rules for living, for a redeemed people. It clarified for them that purity and holiness should characterize their lives as the people of God. It was "child training," through disciplinary restriction and correction, designed to prepare them for the coming of Christ when they as a people would "come of age" (Deut. 6:24; Gal. 3:24, 26; 4:1-7; Titus 2:11-13). The Israelites, however, misinterpreted the purpose of the Law, and sought to obtain righteousness by their obedience and ceremonial rites (Acts 15:1; Rom. 9:31—10:3; 1 Tim. 1:8-10). Israel's history was one long record of violating the Law, even to the point of rejecting their own Messiah—whom Moses told them to heed (Deut. 18:15).

Some years ago, a pastor told me that he encouraged his people to follow the Mosaic Covenant, because the New Testament says it was intended to lead people to Christ (Gal. 3:24). This is a tragic misunderstanding of the Christian's relationship to the Mosaic Law, to be discussed later.

The Mosaic Covenant is an outgrowth of the Abrahamic Covenant, in the sense that it was a significant, intimate agreement between God and Abraham's descendants. By observing it, the Israelites could achieve their purpose as a nation. This purpose was to both experience God's blessing, and to be a blessing to all the nations of the earth (Gen. 12:2). In contrast to the Abrahamic Covenant, Israel now had responsibilities to fulfill in order to obtain God's promised blessings (v. 5). The Mosaic Covenant was, therefore, a conditional covenant. The Abrahamic Covenant—as well as the Davidic and New Covenants that contain expansions of the promises in the Abrahamic Covenant—was unconditional.

A further contrast is this:

"Whereas the Sinaitic covenant was based on an already accomplished act of grace and issued in stringent stipulations, the patriarchal [Abrahamic] covenant rested only on the divine

promise and demanded of the worshipper only his trust (e.g., ch. 15:6)."<sup>1</sup>

"The covenant with Israel at Sinai is to bring Israel into a position of mediatorial service [cf. 19:6]."<sup>2</sup>

"The major difference between the Mosaic covenant and the Abrahamic covenant is that the former was conditional and also was *ad interim*, that is, it was a covenant for a limited period, beginning with Moses and ending with Christ. ...

"In contrast to the other covenants, the Mosaic covenant, though it had provisions for grace and forgiveness, nevertheless builds on the idea that obedience to God is necessary for blessing. While this to some extent is true in every dispensation, the Mosaic covenant was basically a works covenant rather than a grace covenant. The works principle, however, was limited to the matter of blessing in this life and was not related at all to the question of salvation for eternity."<sup>3</sup>

Suppose that a father tells his son that, if he does his chores faithfully, he will reward him with a bicycle at Christmastime. The son is already in the family, so doing his chores faithfully has nothing to do with becoming a member of the family. It is simply a way by which the son can enjoy blessing in the family. Similarly, God told His children, the Israelites, that if they carried out the responsibilities that He was laying on them, they could enjoy blessings from His hand.

The Mosaic Covenant is the heart of the Pentateuch.

"First, it should be pointed out that the most prominent event and the most far-reaching theme in the Pentateuch, viewed entirely on its own, is the covenant between Yahweh and Israel established at Mount Sinai. ...

---

<sup>1</sup>Bright, pp. 91-92.

<sup>2</sup>Eugene H. Merrill, "The Mosaic Covenant: A Proposal for Its Theological Significance," *Exegesis and Exposition* 3:1 (Fall 1988):29.

<sup>3</sup>John F. Walvoord, "The New Covenant," in *Integrity of Heart, Skillfulness of Hands*, pp. 191-92.

"1) The author of the Pentateuch wants to draw a connecting link between God's original plan of blessing for mankind and his establishment of the covenant with Israel at Sinai. Put simply, the author sees the covenant at Sinai as God's plan to restore his blessing to mankind through the descendants of Abraham (Gen 12:1-3; Exod 2:24).

"2) The author of the Pentateuch wants to show that the Covenant at Sinai failed to restore God's blessing to mankind because Israel failed to trust God and obey his will.

"3) The author of the Pentateuch wants to show that God's promise to restore the blessing would ultimately succeed because God himself would one day give to Israel a heart to trust and obey God (Deut 30:1-10)."<sup>1</sup>

The writer interrupted the narrative sections of Exodus with blocks of other explanatory, qualifying, and cultic material in the chapters that follow.<sup>2</sup>

Narr.	Other	Narr.	Other	Narr.	Other	Narr.	Other	Narr.
19:1-3a	19:3b-9	19:10-19a	19:19b-25	20:1-21	20:22—23:33	24:1-18	25—31	32—34

Another scholar observed the following chiastic structure in chapters 19—24:<sup>3</sup>

- A Narrative: the covenant offered (19:3-25)
- B Law: the Decalogue (20:1-17)
- C Narrative: the people's fear (20:18-21)
- B' Law: the Book of the Covenant (20:22—23:33)

<sup>1</sup>John H. Sailhamer, "Exegetical Notes: Genesis 1:1—2:4a," *Trinity Journal* 5 NS (Spring 1984):75, 76.

<sup>2</sup>Durham, p. 258.

<sup>3</sup>Joe M. Sprinkle, "Law and Narrative in Exodus 19—24," *Journal of the Evangelical Theological Society*, 47:2 (June 2004):242.

A' Narrative: the covenant accepted (24:1-11)

### 1. Preparation for the Covenant ch. 19

Moses revealed God's purpose for giving the Mosaic Covenant in this chapter.

19:1-6 The Israelites arrived and pitched their camp at the base of ("in front of") Mt. Sinai (v. 2) exactly three months after they had left Egypt (v. 1). This would have been in early summer, since Passover took place in the spring. The mountain in the Sinai range, that most scholars have regarded as the mountain peak referred to in this chapter, stands in the southeastern part of the Sinai Peninsula. Its name in Arabic is *Jebel Musa*, "Mountain of Moses."<sup>1</sup> There is a natural slope to the land to the southeast of this peak, and another plain to the north, which would have afforded Israel ample space and a good view of the mountain, if the people camped there.

"Only the southern peak of this mountain is Jebel Musa (7363 feet high), while the northern peak is called Ras es-safsafah (6540 feet). Before each peak stretches a plain adequate for the Israelite encampment, but scholars generally favor the one before Jebel Musa as the one used."<sup>2</sup>

However, the location of biblical Mt. Sinai continues to be uncertain. Josephus described it as follows:

"... mount Sinai, which is the highest of all the mountains that are in that country, and is not only very difficult to be ascended by men, on account of its vast altitude, but because of the sharpness of its precipices also ..."<sup>3</sup>

---

<sup>1</sup>See Israel Finkelstein, "Raider of the Lost Mountain—An Israeli Looks at the Most Recent Attempt to Locate Mt. Sinai," *Biblical Archaeology Review* 15:4 (July-August 1988):46-50.

<sup>2</sup>L. Wood, *A Survey ...*, p. 143.

<sup>3</sup>Josephus, *Antiquities of ...*, 3:5:1.

The nation stayed at Mt. Sinai 11 months (Num. 10:11). The record of their experiences here continues through Numbers 10:10.<sup>1</sup>

Many reliable scholars have considered verses 3-6 to be the very heart of the Pentateuch, because they contain the classic expression of the nature and purpose of the theocratic covenant that God made with Israel: the Mosaic Covenant. Some scholars believe the covenant referred to in these verses is the Abrahamic Covenant.<sup>2</sup> Most believe, rightly I think, that it is the Mosaic Covenant. The covenant in view was obviously conditional (v. 5), which the Mosaic Covenant was but the Abrahamic Covenant was not.

"The meaning of this covenant is expounded in the introductory verses of chapter 19: the covenant is an *election*, 'you belong to me from among all peoples'; it is a *bond*, the people will have with Yahweh the particularly close bond of belonging which characterizes the priestly function; it is an *obedience*, for if Yahweh is king, the members of the people can only be the subjects who will follow him everywhere he leads (Ex. 15.18; Num. 23.21; Dt. 33.5; Jg. 8.23)."<sup>3</sup>

God gave the Mosaic Law specifically "to the house of Jacob ... the sons of Israel" (v. 3). This is an extremely important fact to observe. It was law designed to govern the Israelite nation, not all of God's people throughout history.<sup>4</sup>

"The image of the eagle [v. 4] is based on the fact that the eagle, when its offspring learns to fly, will catch them on its wings when they fall."<sup>5</sup>

---

<sup>1</sup>See Appendix 2 for a diagram of Moses' Trips Up Mt. Sinai at the end of these notes.

<sup>2</sup>E.g., William J. Dumbrell, *Creation and Covenant*, pp. 80-9-; Enns, p. 387.

<sup>3</sup>Jacob, p. 212.

<sup>4</sup>For an illustration of the confusion that failure to observe this fact can create in teaching on the Christian's relationship to the Law, see Sakae Kubo, "Why then the Law?" *Ministry* (March 1980), pp. 12-14.

<sup>5</sup>Gispen, p. 179.

"Without doubt Exodus 19:4-6 is the most theologically significant text in the book of Exodus, for it is the linchpin between the patriarchal promises of the sonship of Israel and the Sinaitic Covenant whereby Israel became the servant nation of Yahweh."<sup>1</sup>

God's promise to Israel here (vv. 5-6) went beyond what He had promised Abraham. *If* Israel would be obedient to God, *then* He would do three things for the nation (cf. Josh. 24:15):

1. Israel would become God's special treasure ("My own possession," i.e., royal property,<sup>2</sup> v. 5). This means that Israel would enjoy a unique relationship with God compared with all other nations. This was not due to any special goodness in Israel, but strictly to the sovereign choice of God.<sup>3</sup>
2. Israel would become a "kingdom of priests" (v. 6). This is the first occurrence in Scripture of the word kingdom as referring to God's rule through people on earth.

"This is to be no ordinary kingdom where men will rule upon earth in their own right, but rather a kingdom 'unto me,' that is, unto Jehovah. In other words, whatever else its characteristics may be, it is to be, first of all, *God's* kingdom."<sup>4</sup>

A priest stands between God and human beings. Israel could become a nation of mediators standing between God and the other nations, responsible for bringing them to God and God to them. Israel would not be a kingdom run by politicians, depending on strength and wit, but

---

<sup>1</sup>Merrill, "A Theology ...," p. 32. Cf. Dumbrell, pp. 80-81.

<sup>2</sup>Enns, p. 388.

<sup>3</sup>See Charlie Trimm, "Did YHWH Condemn the Nations When He Elected Israel? YHWH's Disposition Toward Non-Israelites in the Torah," *Journal of the Evangelical Theological Society* 55:3 (September 2012):521-36.

<sup>4</sup>McClain, p. 61.



one of priests, depending on faith in Yahweh: a servant nation rather than a ruling nation.<sup>1</sup>

3. Israel would become "a holy nation" (v. 6). Holy means "set apart" and therefore different. The Israelites would become different from other peoples, because they would devote themselves to God, and separate from sin and defilement as they obeyed the law of God. (In these notes, I have capitalized "Law" when referring to the Pentateuch, the Law of Moses, or the Ten Commandments—and have used the lowercase "law" for all other references to law.)

In short, Israel could have become a testimony to the whole world of how glorious it can be to live under the government of God. As their history unfolded the Israelites experienced these blessings only partially, because their obedience was partial. Israel's disobedience to the Mosaic Covenant did not invalidate any of God's promises to Abraham, however. Those promises did not rest on Israel's obedience, as these did (cf. Gen. 15:17-21 and Exod. 19:5-6).<sup>2</sup> I do not believe that God was giving the Israelites a choice between living under grace or under law, as some have suggested.<sup>3</sup> As we shall see in the following chapters, there was much grace under the Mosaic Law.

- 19:7-15 The reaction of the Israelites to God's promises was understandably positive, and God approved their reaction (Deut. 5:27-28). They wanted what God offered them. However, they overestimated their own ability to keep the covenant, and they underestimated God's standards for them. This twin error is traceable to a failure to appreciate their own sinfulness and God's holiness. The Mosaic Law would teach them to appreciate both more realistically (cf. Deut. 5:29).

---

<sup>1</sup>Durham, p. 263.

<sup>2</sup>See Arnold G. Fruchtenbaum, "Israel and the Church," in *Issues in Dispensationalism*, pp. 113-15, for a good discussion of Israel's national election and how this relates to the individual election of Israelites.

<sup>3</sup>E.g., McGee, 1:262.

"Man naturally believes in, and depends on, himself. And he must learn, at bitter cost often, of his own helplessness."<sup>1</sup>

God designed the procedures He specified in verses 10-15 to help the people realize the difference between their holy God and their sinful selves. Notice that God separated Himself from the Israelites both spatially and temporally.

"It becomes us to appear in clean clothes [v. 10] when we wait upon great men; so clean hearts are required in our attendance on the great God, who sees them as plainly as men see our clothes."<sup>2</sup>

The temporary prohibition against normal sexual relations ("do not go near a woman," v. 15) seems intended to impress the importance of this occasion on the Israelites and to help them concentrate on it. We should not infer from this command that a married couple's normal sexual relations are sinful (cf. Gen. 1:28; 9:1, 7).

19:16-25 God again used the symbol of fire to reveal Himself on this mountain (3:2-5). Fire is a symbol of His holiness that enlightens, purges, and refines. The smoke and quaking that accompanied the fire further impressed this awesome revelation on the people. The very loud trumpet sound evidently came from heaven (cf. Matt. 24:31; 1 Cor. 15:52; 1 Thess. 4:16; Rev. 8:13). Immanuel Velikovsky proposed that a volcanic eruption took place with accompanying trumpet-like sounds, though he acknowledged that the traditional Mt. Sinai is not volcanic.<sup>3</sup>

The priests referred to (vv. 22, 24) were evidently young men (firstborn?) who offered sacrifices before God appointed the Aaronic priests to this service (cf. 24:5).

Comparative ancient Near Eastern studies have revealed that the covenant form and terminology that God used to communicate His agreement with

---

<sup>1</sup>Newell, p. 163.

<sup>2</sup>Henry, p. 92.

<sup>3</sup>Velikovsky, pp. 108-11.

Israel were common in Moses' day. There were two basic types of formal covenants in the ancient Near East: *parity* (between equals) and *suzerainty* (between a sovereign and his subjects). The Mosaic Covenant was a suzerainty treaty. Such agreements characteristically contained a preamble (v. 3), historical prologue (v. 4), statement of general principles (v. 5a), consequences of obedience (vv. 5b-6a), and consequences of disobedience (omitted here). In 1977, Kenneth Kitchen wrote the following:

"Some forty different [suzerainty] treaties ... are known to us, covering seventeen centuries from the late third millennium BC well into the first millennium BC, excluding broken fragments, and now additional ones still to be published from Ebla."<sup>1</sup>

Thus the form in which God communicated His covenant to Moses and Israel was undoubtedly familiar to them. It enabled them to perceive better the nature of the relationship into which they were entering.<sup>2</sup>

The Mosaic Law consisted of three classes of requirements: those governing *moral* life (the Ten Commandments), those governing *religious* life (the ceremonial ordinances), and those governing *civil* life (the civil statutes). The commandments expressed the righteous will of God (Exod. 20), the judgments governed Israel's social life (Exod. 21:1—24:11), and the ordinances determined Israel's religious life (Exod. 24:12—31:18). God gave the whole Law *specifically* for the nation of Israel (v. 3).

"Under the law there were certain things which were commanded because they were right. Others were right because they were commanded."<sup>3</sup>

It is very important to recognize how comprehensive the Mosaic Law was, and not limit it to the Ten Commandments.<sup>4</sup> The rabbis, following Maimonides, counted 613 commands, 248 positive and 365 negative, in the law.<sup>5</sup> Maimonides was a Jewish philosopher and exegete who lived in

---

<sup>1</sup>Kenneth Kitchen, *The Bible In Its World*, p. 79.

<sup>2</sup>See George E. Mendenhall, *Law and Covenant in Israel and the Near East*; Meredith Kline, *The Treaty of the Great King*; F. C. Fensham, "Extra-biblical Material and the Hermeneutics of the Old Testament with Special Reference to the Legal Material of the Covenant Code," *OTWSA* 20 & 21 (1977 & 78):53-65.

<sup>3</sup>H. A. Ironside, *The Continual Burnt Offering*, the meditation for Sept. 18.

<sup>4</sup>See McClain, pp. 65-90: "The Constitution and Laws of the Kingdom in History."

<sup>5</sup>Edersheim, p. 129, f. 5.

the twelfth century A.D. and wrote *Sepher Mitzvoth* ("Book of the Commandments"), the definitive Jewish list of laws in the Pentateuch.<sup>1</sup>

"'From Moses to Moses there arose none like unto Moses,' was the verdict of posterity upon Maimonides, the most influential Jewish thinker in the Middle Ages. As an expounder of Judaism, as a philosopher, as a lover of learning, as a gentle, human character, few have surpassed him in Jewish history."<sup>2</sup>

There were three categories of law in Israel:

1. *Crimes* were actions that the community prohibited under the will of God and punished in its name. Murder (Exod. 21:12), adultery (Lev. 20:10; Deut. 22:22), and the kidnapping of persons for sale outside Israel (Exod. 21:16) are examples of crimes. These offenses resulted in the punishment of the guilty party by the community as a community (Exod. 21:12-16).
2. *Torts* were civil wrongs that resulted in an action by the injured party against the party who had wronged him. Assault (Exod. 21:18-27), the seduction of an unmarried or betrothed girl (Exod. 22:16-17), and theft of animals or other property (Exod. 22:1-4) are examples of torts. Conviction resulted in the guilty party paying damages to the injured party (Exod. 21:18-27).
3. *Family law* did not involve the courts, but the head of the household administered it in the home. Divorce (Deut. 24:1-4), the making of slavery permanent (Exod. 21:1-6), and adoption (cf. Gen. 15:2; 30:3; 48:5, 12; 2 Sam. 7:14; Ps. 2:7) are examples. In these cases, the head of the household acted unilaterally. He did not, however, have the power of life or death.<sup>3</sup>

God gave the Mosaic Law to the Israelites for several purposes:

1. To reveal the holiness of God (1 Peter 1:15)

---

<sup>1</sup>For a summary of Maimonides' list, see the Appendix in Sailhamer, *The Pentateuch ...*, pp. 481-516.

<sup>2</sup>Sachar, p. 178.

<sup>3</sup>See Anthony Phillips, *Ancient Israel's Criminal Law*, and idem, "Some Aspects of Family Law in Pre-Exilic Israel," *Vetus Testamentum* 23 (1973):349-361, for further discussion of these categories.

2. To reveal the sinfulness of man (Gal. 3:19)
3. To reveal the standard of holiness required of those in fellowship with God (Ps. 24:3-5)
4. To supervise physical, mental, and spiritual development of redeemed Israelites until they should come to maturity in Christ (Gal. 3:24; Ps. 119:71-72)
5. To be the unifying principle that made the establishment of the nation possible (Exod. 19:5-8; Deut. 5:27-28)
6. To separate Israel from the nations in order to enable them to become a kingdom of priests (Exod. 19:5-6; 31:13)
7. To make provision for forgiveness of sins and restoration to fellowship (Lev. 1—7)
8. To make provision for a redeemed people to worship by observing and participating in the yearly festivals (Lev. 23)
9. To provide a test that would determine whether one was in the kingdom (theocracy) over which God ruled (Deut. 28)
10. To reveal Jesus Christ (Luke 24:27)

J. Dwight Pentecost concluded his article on the purpose of the Law by pointing out the following:

"... there was in the Law that which was *revelatory* of the holiness of God..." There was also " ... that in the Law which was *regulatory*."<sup>1</sup>

"It is extremely important to remember that the Law of Moses was given to *a redeemed people*, not to *redeem a people*."<sup>2</sup>

"... it is also possible that the Pentateuch has intentionally included this selection of laws for another purpose, that is, *to give the reader an understanding of the nature of the Mosaic*

---

<sup>1</sup>J. Dwight Pentecost, "The Purpose of the Law," *Bibliotheca Sacra* 128:511 (July-September 1971):233. See also idem, *Thy Kingdom ...*, pp. 88-93.

<sup>2</sup>Ibid., p. 87. Cf. Johnson, p. 68.

*Law and God's purpose in giving it to Israel.* Thus it is possible to argue that the laws in the Pentateuch are not there to tell the *reader* how to live but rather to tell the reader how Moses was to live under the law.

"This understanding of the purpose of the laws in the Pentateuch is supported by the observation that the collections of laws in the Pentateuch appear to be incomplete and selective. The Pentateuch as such is not designed as a source of legal action. That the laws in the Pentateuch are incomplete is suggested by the fact that many aspects of ordinary community life are not covered in these laws."<sup>1</sup>

John Calvin understood the function of the moral part of the Mosaic law as being threefold: to convict people of their unrighteousness, to restrain people by fear of punishment, and to educate people concerning God's will for them.<sup>2</sup> J. Sidlow Baxter also gave three reasons why God gave Israel the Mosaic Law: to provide a standard of righteousness, to expose and identify sin, and to reveal the Divine holiness.<sup>3</sup>

A movement that has gained some followers, especially in the United States, is the "Christian Reconstruction" movement, also known as the "theonomy" movement, and the "Chalcedon school." Its central thesis is that God intended the Mosaic Law to be normative for all people for all time. Its advocates look forward to a day when Christians will govern everyone using the Old Testament as the law book. Reconstructionism rests on three foundational points: presuppositional apologetics, theonomy (lit. "the rule of God"), and postmillennialism. The main flaw in this system, from my perspective, is its failure to distinguish God's purposes for Israel from His purposes for the church.<sup>4</sup>

---

<sup>1</sup>Sailhamer, "The Mosaic ...," pp. 244, 245.

<sup>2</sup>John Calvin, *Institutes of the Christian Religion*, 2:7:6, 10, and 12.

<sup>3</sup>J. Sidlow Baxter, *Explore the Book*, 1:87.

<sup>4</sup>For a popular introduction to this movement, see Gary DeMar, *The Debate over Christian Reconstruction*, pp. 13-55; Rodney Clapp, "Democracy as Heresy," *Christianity Today* (February 20, 1987), pp. 17-23. See also Robert Lightner, "Theological Perspectives on Theonomy," *Bibliotheca Sacra* 143:569 (January-March 1986):26-36; 143:570 (April-June 1986):134-45; and 143:571 (July-September 1986):228-45, for a scholarly dispensational critique; and Meredith Kline, "Comments on an Old-New Error," *Westminster Theological Journal* 41:1 (Fall 1978):172-89, for a scholarly reformed evaluation of the movement. The essay by Douglas Chismar and David Raush, "Regarding Theonomy: An

"Theonomy used to be an attractive lens through which to read Scripture for many Christians, particularly in Reformed and Pentecostal circles in the 1970s and into the 1990s, among those who looked with horror at the secularization of society and longed for a more powerful Christian influence. Fortunately, as we begin the twenty-first century this movement has lost significant influence."<sup>1</sup>

However, in the early decades of the 21<sup>st</sup> century there has been a resurgence of this movement.

The whole Mosaic Law, in all of its parts, was given to the nation of Israel, not to the church (cf. 19:3). Israel was a *physical* nation: with a homeland, a capital city (eventually), citizens composed of Jews and naturalized proselytes, and believers and nonbelievers. The church is a *spiritual* nation: with no homeland on this earth, no capital city on earth, citizens composed of Jews and Gentiles without distinction, and believers only.

What is the Christian's relationship to the Mosaic Law? We are not under it (Rom. 10:4; 1 Cor. 9:20; Gal. 5:18; Heb. 7:12). It is not the code that regulates the behavior of believers today, though 9 of the Ten Commandments have been incorporated into (repeated in) the covenant under which Christians live, the exception being the fourth commandment. Are Christians under *any* code of laws, like the Israelites were? Yes. Paul referred to our code of laws as the Law of Christ (Gal. 6:2; 1 Cor. 9:21). Other names are the Law of Liberty (James 1:25; 2:12) and the New Covenant (2 Cor. 3:6; Heb. 8:8, 13; 12:24).

There are similarities and differences between the Law of Moses and the Law of Christ. They both contain positive and negative commands. Some of the commands in both are identical, but other commands appear in one code but not the other. Similarly, there are many of the same commands in English law as there are in American law. For example, it is illegal to commit murder under both codes of law. But there are also significantly different commands. For example, under English law it is illegal to drive on the right hand side of the road, but under American law it is illegal to drive

---

Essay of Concern," *Journal of the Evangelical Theological Society* 27:3 (September 1984):315-23, is also helpful.

<sup>1</sup>Longman and Dillard, p. 76.

on the left side. The empowerment of the Holy Spirit is not the only difference between the two covenants, as some Christians assume.

What value does the Mosaic Law have for Christians today? All Scripture is profitable (2 Tim. 3:16), and the Mosaic Law is part of Scripture. The Mosaic Code had two main purposes: regulatory and revelatory. Calvin called these their ceremonial and moral purposes. The Mosaic Law does not regulate or rule over the lives of Christians, as it did the lives of the Israelites (Gal. 4:8-11), but it does reveal much about God, man, and the divine human relationship. Therefore, we should read and study this portion of Scripture, even though we are not obligated to keep all of its commands or observe all of its ceremonies and rituals.

We can tell which ones we are to keep by comparing the Law of Moses with the Law of Christ. The Law of Christ consists of all the teaching that Christ gave, both during His earthly ministry, and through His apostles and prophets after He went back to heaven (cf. Acts 1:1-2). Principles revealed in the Mosaic Law can help us to clarify our responsibilities as well. For example, we can learn what it means to love our neighbor by observing how God wanted the Israelites to treat one another and non-Israelites.

Were the Israelites saved by keeping the Mosaic Law? No! They were saved by faith, not by works (Rom. 3:18-30).

Two brothers were crossing the Atlantic Ocean on a ship. They had decided to immigrate to America from their European homeland. Standing by the rail, looking out over the water, one brother said to the other, "How are we going to become citizens of the United States?" His brother replied, "I think you have to keep all the laws of the land to become a citizen." That, of course, is not true. One has to go through a naturalization process to become a citizen; he or she does not need to keep all the laws of the land. Yet many people believe that in order to become a citizen of heaven, one must keep all the rules that God has laid out for His people. On the contrary, though, He has established a naturalization process, which involves trusting in the Person and work of His Son.

The biblical covenants are the basis for our understanding God's great plans and purposes for humanity throughout history. Dispensationalists emphasize the biblical covenants (Abrahamic, Mosaic, Davidic, New, et al.). The theological covenants (works, redemption, and grace) are also explanations of how God is working with humanity. Covenant theologians



put much emphasis on these covenants.<sup>1</sup> Dispensational explanations are more persuasive to me.

## 2. The Ten Commandments 20:1-17

"We now reach the climax of the entire Book, the central and most exalted theme, all that came before being, as it were, a preparation for it, and all that follows, a result of, and supplement to it."<sup>2</sup>

There are two types of law in the Old Testament, and these existed commonly in the ancient Near East:

*Apodictic laws* are commands with the force of categorical imperatives. They are positive or negative. The Ten Commandments are an example of this type of law, which occurs almost exclusively in the Old Testament, and rarely in other ancient Near Eastern law codes. "Thou shalt ..." and "Thou shalt not ..." identify this type of law.

*Casuistic laws* are commands that depend on qualifying circumstances. They are also positive or negative, and there are many examples in the Mosaic Law (e.g., 21:2-11, et al.), as well as in other ancient Near Eastern law codes. This type of law is identifiable by the "If ... then ..." construction.

Compared with other ancient Near Eastern codes, the Decalogue (Ten Commandments) is positive and concise.

"Six [other ancient Near Eastern codes] are known: (1) the Urnammu code, c. 2050 B.C., from the Third Dynasty of Ur; (2) the code of Balalama, c. 1925 B.C., from Eshnunna; (3) the code of Lipit-Ishtar, c. 1860 B.C., from Isin; (4) the code of Hammurabi, c. 1700 B.C., from Babylon; (5) the Hittite code, c. 1450 B.C., from Boghazkoi; and (6) the Assyrian code, c. 1350 B.C., from Assur."<sup>3</sup>

God allowed the Israelites much freedom. There were comparatively few restrictions on their personal behavior (cf. Gen. 1:29-30; 2:16-17).

---

<sup>1</sup>See Hodge, 2:117-22, 354-77.

<sup>2</sup>Cassuto, p. 235.

<sup>3</sup>L. Wood, *A Survey ...*, pp. 149-50. See also Mendenhall; Pritchard, pp. 159-98.

"The Ten Commandments were unique in Old Testament times because they possessed prohibitions in the second person singular and because they stressed both man's exclusive worship of one God and man's honoring the other person's body, rights, and possessions. Breaking these commandments would result in spiritual confusion and in human exploitation."<sup>1</sup>

The Ten Commandments use verbs, not nouns. Nouns leave room for debate, but verbs do not. God gave His people ten *commandments*, not ten suggestions. They were designed to bring order back into life following the chaos that sin and enslavement produce.<sup>2</sup>

Though Moses did not mention it here, angels played some part in mediating the law from God to the Israelites through Moses (cf. Deut. 33:2; Gal. 3:19; Heb. 2:2).

### **Preface 20:1-2**

These verses form a preamble and historical background to the Decalogue that follows. They provide a frame of mind with which the Israelites were to understand what follows. The Israelites were to obey God on the double basis of who He is ("I am the LORD your God") and what He had done for them ("who brought you out of the land of Egypt, out of the house of slavery," v. 2).

"The law, in other words, is connected to grace. It is based on God's gracious act of saving his people; it is not a condition of becoming God's people, for that has already happened in the Exodus."<sup>3</sup>

Most scholars have divided the Ten Commandments (cf. Deut. 5:6-18) into two groups, but in two different ways:

The older Jewish method, called "Philonic," after the Jewish scholar Philo, was to divide them in two groups of five commandments each. The Jews believed that this was how God divided them on the two tablets of stone.<sup>4</sup>

---

<sup>1</sup>Livingston, *The Pentateuch ...*, p. 158.

<sup>2</sup>See Terence E. Fretheim, *Exodus*, p. 204; Enns, p. 411.

<sup>3</sup>*Ibid.*, p. 412.

<sup>4</sup>See Josephus, *Antiquities of ...*, 3:5:8.

The newer Christian method, called "Augustinian," after the church father Augustine (who followed Origin in this view), divided them into the first four and the last six commandments.<sup>1</sup> The basis for this division is subject matter. The first four commands deal with man's relationship with God, and the last six with his relationship with other people (cf. Matt. 22:36-40). (A similar arrangement exists in Jesus' teaching on the Lord's Prayer [Matt. 6:9-13; Luke 11:2-4].)

Some scholars believe that each tablet originally contained all ten commandments, in keeping with the ancient Near Eastern custom of making duplicate copies of covenant documents.<sup>2</sup>

"Before the discovery of ancient treaty patterns and their relation to the Ten Commandments, many people assumed that the two tables of the Law (see 34:1) were divided on the basis of laws relating to God and those relating to other people. In this approach the fifth command, in this verse [v.12], would begin the second tablet. Following our understanding of ancient treaties, however, it is probable that each of the tablets contained all ten commandments. In the ancient world, one copy of a treaty would be placed in the principal temple of each contracting party. Here both copies were kept together before God and the people in the Most Holy Place."<sup>3</sup>

One of the questions that readers of the Ten Commandments often have is: Why were these particular commands chosen, rather than some others? For example, why did God prohibit false witness rather than lying (Exod. 20:16)? Calvin answered this question as follows:

"... God has set forth by way of example the most frightful and wicked element in every kind of transgression, at the hearing of which our senses might shudder, in order that he might

---

<sup>1</sup>So also did Calvin, 2:8:12.

<sup>2</sup>Kline, *Treaty of ...*, ch. 2: "The Two Tables of the Covenant," pp. 13-26; idem, "Deuteronomy," in *The Wycliffe Bible Commentary*, p. 161; Jack S. Deere, "Deuteronomy," in *The Bible Knowledge Commentary: Old Testament*, p. 270.

<sup>3</sup>*The Nelson ...*, p. 136.

imprint upon our minds a greater detestation of every sort of sin."<sup>1</sup>

This explanation concludes that God had more in mind than just bearing false witness, for example. Jesus clarified, in the Sermon on the Mount, that a larger application was indeed God's intent (cf. Matt. 5:21-22, 27-28, et al). In the exposition to follow, I will record what Calvin understood to be the larger meaning of each commandment and its rationale.

Additionally, these commandments were given to the Israelites as a community. God intended them to govern the life of the nation, not just the behavior of individual Israelites.

### The first commandment 20:3

"The Lutheran and Roman Catholic churches follow Augustine in making verses 2-6 the first commandment, and then dividing verse 17, on covetousness, into two. Modern Judaism makes verse 2 the first commandment and verses 3-6 the second. The earliest division, which can be traced back at least as far as Josephus, in the first century A.D., takes 20:3 as the first command and 20:4-6 as the second. This division was supported unanimously by the early church, and is held today by the Eastern Orthodox and most Protestant churches."<sup>2</sup>

Some scholars have argued that the first commandment comprises verses 3-6, the second commandment verse 7, etc., and the tenth commandment begins: "You shall not covet your neighbor's wife" in verse 17b.<sup>3</sup> Most scholars do not accept this view.

This first commandment was a call to monolatry (the worship of only one God) and faithfulness to the LORD. Israel was to have "no other gods" besides Yahweh. He was not just to be the first among several (henotheism), since He is the only God (monotheism; cf. 1 Cor. 10:31; 1 Tim. 2:5; Acts 14:15; James 2:19; 1 John 5:20-21).

"Yahweh had opened himself to a special relationship with Israel, but that relationship could develop only if Israel

---

<sup>1</sup>Calvin, 2:8:10. See also Hodge, 3:362.

<sup>2</sup>Johnson, p. 69.

<sup>3</sup>E.g., Sailhamer, *The Pentateuch ...*, pp. 284-85.

committed themselves to Yahweh alone. Yahweh had rescued them and freed them, delivered them and guided them, then come to them. The next step, if there was to be a next step, belonged to them. If they were to remain in his Presence, they were not to have other gods."<sup>1</sup>

"The purpose of this commandment is that the Lord wills alone to be pre-eminent among his people, and to exercise complete authority over them. To effect this, he enjoins us to put far from us all impiety and superstition, which either diminish or obscure the glory of his divinity. For the same reason he commands us to worship and adore him with true and zealous godliness. The very simplicity of the words well-nigh expresses this. For we cannot 'have' God without at the same time embracing the things that are his. Therefore, in forbidding us to have strange gods, he means that we are not to transfer to another what belongs to him. Even though there are innumerable things that we owe to God, yet they may be conveniently grouped in four headings: (1) adoration (to which is added as an appendix, spiritual obedience of the conscience), (2) trust, (3) invocation, (4) thanksgiving."<sup>2</sup>

"We think that idols are bad things, but that is almost never the case. The greater the good, the more likely we are to expect that it can satisfy our deepest needs and hopes. Anything can serve as a counterfeit god, especially the very best things in life. What is an idol? It is anything more important to you than God, anything that absorbs your heart and imagination more than God, anything you seek to give you what only God can give."<sup>3</sup>

### The second commandment 20:4-6

"As the first commandment forbids any association with other gods to those who would be Yahweh's, the second

---

<sup>1</sup>Durham, p. 285.

<sup>2</sup>Calvin, 2:8:16.

<sup>3</sup>Timothy Keller, *Counterfeit Gods*, p. xix. Paragraph division omitted.

commandment and the two that follow it set special dimensions of their relationship with him."<sup>1</sup>

"In the first commandment worshipping a false god is forbidden; in this, worshipping the true God in a false manner."<sup>2</sup>

This command was a prohibition against making an idol or any likeness of Yahweh, or any other thing, *as an object of worship* (v. 5). God did not forbid making pictures or images of angels, people, animals, or other creatures. The rationale behind this command is that God Himself is to be the only object of worship (v. 5).

Any likeness of God demeans Him, and hinders—rather than advances—His worship.<sup>3</sup>

"It can hardly be doubted that this rejection of any formal representation of Yahweh voices a conviction that God, though always close at hand, cannot be adequately presented under any form derived from Nature."<sup>4</sup>

Furthermore, by making an image to worship, people put themselves in a position of sovereignty over the thing represented by the image. God wanted His people to accept their place as the creatures of the Creator. The Israelite who made an image of Yahweh would put himself or herself in the position of the creator, and Yahweh in the place of a created thing. Also, he or she would face the temptation to confuse the image with God, and worship it rather than Him. There are 14 different words and synonyms for idols and images in the Old Testament.<sup>5</sup>

"We may not make images of God for He has already done so! *We are His images; it is we who are in His likeness.* This is the reason God values people so much: We are made to reflect His majesty on earth."<sup>6</sup>

---

<sup>1</sup>Durham, p. 285.

<sup>2</sup>Thomas Watson, *The Ten Commandments*, p. 59.

<sup>3</sup>See Calvin, 1:11:1 and 2; J. I. Packer, *Knowing God*, pp. 38-44..

<sup>4</sup>Walther Eichrodt, *Theology of the Old Testament*, 1:215.

<sup>5</sup>Kaiser, "Exodus," revised ed., p. 480.

<sup>6</sup>*The Nelson ...*, p. 5.

Human sinfulness obscures God's image in man, but we learn what God is like by observing human beings and human behavior. The perfect man, Jesus Christ, manifested God perfectly (Col. 1:15).

"The purpose of this commandment, then, is that he does not will that his lawful worship be profaned by superstitious rites. To sum up, he wholly calls us back and withdraws us from petty carnal observances, which our stupid minds, crassly conceiving of God, are wont to devise. And then he makes us conform to his lawful worship, that is, a spiritual worship established by himself. ...

"The commandment has two parts. The first restrains our license from daring to subject God, who is incomprehensible, to our sense perceptions, or to represent him by any form. The second part forbids us to worship any images in the name of religion."<sup>1</sup>

"Our religious worship must be governed by the power of faith, not by the power of imagination."<sup>2</sup>

The consequences of disobedience to this command would continue for a few ("the third and the fourth generations," v. 5), as the later history of Israel illustrates. However, obedience to it would result in blessing for limitless generations ("to thousands;" cf. Deut. 7:9-10). Disobedience to this commandment—indeed, all of them—had societal consequences.

"Yahweh's jealousy is a part of his holiness (Exod 34:14) and is demanded by what he *is*. It is justified by the fact that it comes only upon those who, having promised to have no God but him, have gone back on that promise. Those who do so show that they 'hate' him, that they hold him in contempt: upon them in result must come a deserved judgment, across four generations."<sup>3</sup>

"The use of images and the human control of the god that was a part of their use would infringe on the freedom of Yahweh to manifest himself when and how he sovereignly determined. By

---

<sup>1</sup>Calvin, 2:8:17.

<sup>2</sup>Henry, p. 93.

<sup>3</sup>Durham, p. 287. See also Packer, pp. 151-58.

prohibiting the one means by which the gods of the people around Israel supposedly manifested themselves Israel was protected from the assimilation of foreign religious values, and the prohibition of images played a significant role in the successful survival of Israel's religion. It seems clear that the prohibition of images both in practice and in its theological basis is but another example of the fundamentally different religious value-system that distinguished Israel from her ancient Near Eastern contemporaries."<sup>1</sup>

"Through [Canaanite] sacrifice to the idol, large amounts of material productivity were funneled into the control of the Canaanite priestly and royal classes. The idol was therefore a kind of tax or tribute gathering device. In this context, Israelite hostility to cultic images yields to a possible two-fold interpretation. First, by repudiating the cultic image, Israel rid itself of an important source of wealth for the ruling classes, thereby thwarting possible internal programs seeking to re-establish political hierarchy. Second, frontier Israel was insuring [*sic* ensuring] that agricultural goods used in cultic sacrifice would be circulated back into the producing community [cf. Deut. 12:5-7; 26:12-15]. An imageless cult was one way of enhancing political and economic self-sufficiency."<sup>2</sup>

### The third commandment 20:7

Taking Yahweh's "name ... in vain" means using the name of God emptily, carelessly, profanely, for no purpose, in a common way. The name of God represents the Person of God. The Israelites were to show respect for the Person of God by their use of His name. They were not to use it simply for emphasis, or for any unworthy objective in their speech (cf. Matt. 5:33-37; James 5:12).

"The third commandment is directed not toward Yahweh's protection, but toward Israel's. Yahweh's name, specifically the tetragrammaton but in principle *all* Yahweh's names and titles, must be honored, blessed, praised, celebrated, invoked,

---

<sup>1</sup>Edward M. Curtis, "The Theological Basis for the Prohibition of Images in the Old Testament," *Journal of the Evangelical Theological Society* 28:3 (September 1985):287.

<sup>2</sup>James M. Kennedy, "The Social Background of Early Israel's Rejection of Cultic Images: A Proposal," *Biblical Theology Bulletin* 17:4 (October 1987):138.



pronounced, and so shared. To treat Yahweh's name with disrespect is to treat his gift lightly, to underestimate his power, to scorn his Presence, and to misrepresent to the family of humankind his very nature as 'The One Who Always Is.'"<sup>1</sup>

The "tetragrammaton" refers to the four-letter Hebrew name YHWH, translated Yahweh.

"The purpose of this commandment is: God wills that we hallow the majesty of his name. Therefore, it means in brief that we are not to profane his name by treating it contemptuously and irreverently. ...

"We must, in my opinion, diligently observe the three following points: First, whatever our mind conceives of God, whatever our tongue utters, should savor of his excellence, match the loftiness of his sacred name, and lastly, serve to glorify his greatness. Secondly, we should not rashly or perversely abuse his Holy Word and worshipful mysteries either for the sake of our own ambition, or greed, or amusement; but, as they bear the dignity of his name imprinted upon them, they should ever be honored and prized among us. Finally, we should not defame or detract from his works, as miserable men are wont abusively to cry out against him, but whatever we recognize as done by him we should speak of with praise of his wisdom, righteousness, and goodness. That is what it means to hallow God's name."<sup>2</sup>

"We take God's name in vain, [1] By hypocrisy, making a profession of God's name, but not living up to that profession. Those that name the name of Christ, but do not depart from iniquity, name it in vain. [2] By covenant-breaking; if we make promises to God, binding our souls with those bonds to that which is good, and yet perform not to the Lord our vows, we take his name in vain (Matt. v. 23). [3] By rash swearing, mentioning the name of God as a by-word, to no purpose at all, or to no good purpose. [4] By false swearing. One part of the religious regard the Jews were taught to pay to their God

---

<sup>1</sup>Durham, p. 288.

<sup>2</sup>Calvin, 2:8:22. See his discussion of oaths in 2:8:23-27.

was to *swear by his name*, Deut. x. 20. But they affronted him, instead of doing him honour, if they called him to be witness to a lie."<sup>1</sup>

Taking God's name in vein also includes (1) saying something false about God, and (2) using His name to curse others.<sup>2</sup>

### The fourth commandment 20:8-11

The Sabbath (lit. "Rest") day was the seventh day of the week: Saturday. This day was to be a day of rest for the Israelites, because God ceased from His creation activity on the seventh day (v. 11; Gen. 2:3). To "remember" the day does not mean simply to recall it from memory but to act appropriately in view of the significance of the day.

"If the miracle of creation was not finished within six literal twenty-four-hour days, there is no foundation for keeping the fourth commandment."<sup>3</sup>

Note that part of this commandment is to work. Work was given to Adam and Eve in the Garden of Eden, and it is still God's will that people work (cf. 2 Thess. 3:10). The opposite is doing no work: being a freeloader, lazy, idle.<sup>4</sup>

God "blessed" the Sabbath day and "made it holy" (v. 11), in that He made it special and different from the other days of the week for Israel.

"Who must observe it: *Thou, and thy son, and thy daughter*, the wife is not mentioned, because she is supposed to be one with the husband and present with him."<sup>5</sup>

This is the only one of the Ten Commandments not reiterated for Christians in the New Testament. Traditionally, the church has celebrated the *first* day

---

<sup>1</sup>Henry, p. 94.

<sup>2</sup>Enns, p. 417.

<sup>3</sup>Paul Gregor, "Creation Revisited: Echoes of Genesis 1 and 2 in the Pentateuch," in *The Genesis Creation Account and Its Reverberations in the Old Testament*, p. 134.

<sup>4</sup>See G. Campbell Morgan, *The Ten Commandments*, pp. 45-46.

<sup>5</sup>Henry, p. 94.

of the week as a memorial to Jesus Christ's resurrection, which event is the ground of *our* rest (Rom. 4:25).<sup>1</sup>

"The purpose of this commandment is that, being dead to our own inclinations and works, we should meditate on the Kingdom of God, and that we should practice that meditation in the ways established by him. ...

"First, under the repose of the seventh day the heavenly Lawgiver meant to represent to the people of Israel spiritual rest, in which believers ought to lay aside their own works to allow God to work in them. Secondly, he meant that there was to be a stated day for them to assemble to hear the law and perform the rites, or at least to devote it particularly to meditation upon his works, and thus through this remembrance to be trained in piety. Thirdly, he resolved to give a day of rest to servants and those who are under the authority of others, in order that they should have some respite from toil."<sup>2</sup>

"... there is no doubt that by the Lord Christ's coming the ceremonial part of this commandment was abolished. ... Although the Sabbath has been abrogated, there is still occasion for us: (1) to assemble on stated days for the hearing of the Word, the breaking of the mystical bread, and for public prayers [cf. Acts 2:42]; (2) to give surcease [cessation and relief] from labor to servants and workmen."<sup>3</sup>

Whereas before Christ the Israelites worked in anticipation of rest, since Christ believers work in response to the rest that He has provided by His death and resurrection.

---

<sup>1</sup>See Arnold G. Fruchtenbaum, "The Sabbath Controversy," *Biblical Research Monthly* 49:4 (July-August 1984):15-16; Gerhard Hasel, "The Sabbath in the Pentateuch," in *The Sabbath in Scripture and History*, pp. 21-43; Merrill F. Unger, "The Significance of the Sabbath," *Bibliotheca Sacra* 123:489 (January 1966):53-59.

<sup>2</sup>Calvin, 2:8:28.

<sup>3</sup>*Ibid.*, 2:8:32.

## The fifth commandment 20:12

"The first four commandments set forth the principles guiding Israel's relationship to Yahweh; and the last six commandments set forth the principles guiding Israel's relationship with the covenant community, and more broadly, with the human family. As the second, third, and fourth commandments are in many ways extensions of the first commandment, the first four commandments are the foundation for the final six commandments. And *all* of the commandments, as principles governing covenant relationships, are founded on the ultimate OT statement of relationship, which stands as prologue to the ten commandments: 'I am Yahweh, your God' ... Because Yahweh is, and is *Israel's* God, Israel both *is* and *must become* a certain and special people."<sup>1</sup>

All Israelites were to honor their parents, because parents are God's representatives to their children in God's administrative order of society. Thus the fifth commandment is as foundational to commandments six through ten, as the first commandment is to commandments two through four. The Israelites were to honor God because He had given them life, and they were to honor their parents because they were His instruments in giving them life.<sup>2</sup> The promise of long life in "the land which the LORD your God gives you" is a reminder that God gave the command to Israelites.

"This 'promise' is not personal blessing, but a blessing for a people to possess a land under God's rule and thus become a light to the nations."<sup>3</sup>

The Apostle Paul repeated this responsibility as binding on the church in Ephesians 6:1-3, but changed the verb to "obey," as well as the promise (cf. Matt. 15:3-4; Col. 3:20).<sup>4</sup>

"The purpose is: since the maintenance of his economy pleases the Lord God, the degrees of pre-eminence established by him

---

<sup>1</sup>Durham, p. 290.

<sup>2</sup>See Charlie Trimm, "Honor Your Parents: A Command for Adults," *Journal of the Evangelical Theological Society* 60:2 (June 2017):247-63.

<sup>3</sup>Enns, p. 421.

<sup>4</sup>See Maurice E. Wagner, "How to Honor Your Parents When They've Hurt You," *Psychology for Living* 28:6 (June 1986):12-14.

ought to be inviolable for us. This, then, is the sum: that we should look up to those whom God has placed over us, and should treat them with honor [cf. Exod. 21:17; Lev. 20:9; Prov. 20:20], obedience [cf. Deut. 21:18-21; Eph. 6:1-3; Col. 3:20], and gratefulness [cf. Matt. 15:4-6]. It follows from this that we are forbidden to detract from their dignity either by contempt, by stubbornness, or by ungratefulness. For the word 'honor' has a wide meaning in Scripture. ... Accordingly, he has put forward as an example that kind of superiority which is by nature most amiable [pleasant] and least invidious [likely to arouse resentment], because he could thus more easily soften and bend our minds to the habit of submission. By that subjection which is easiest to tolerate, the Lord therefore gradually accustoms us to all lawful subjection, since the reason of all is the same."<sup>1</sup>

### The sixth commandment 20:13

God did not forbid all kinds of killing. In fact, He commanded capital punishment and some war, both of which involve killing. The Hebrew word used here specifies "murder," not just killing. The Israelites were to execute murderers and others under the Mosaic Law. However, God prohibited taking a human life without divine authorization. This included suicide.<sup>2</sup>

"The purpose of this commandment is: the Lord has bound mankind together by a certain unity; hence each man ought to concern himself with the safety of all. To sum up, then, all violence, injury, and any harmful thing at all that may injure our neighbor's body are forbidden to us. ... Therefore this law also forbids murder of the heart, and enjoins the inner intent to save a brother's life [cf. 1 John 3:15; Matt. 5:22]."<sup>3</sup>

"Scripture notes that this commandment rests upon a twofold basis: man is both the image of God, and our flesh. Now, if we do not wish to violate the image of God, we ought to hold our

---

<sup>1</sup>Calvin, 2:8:35.

<sup>2</sup>See J. P. Morgan, "The Morality of Suicide: Issues and Options," *Bibliotheca Sacra* 148:590 (April-June 1991):214-30; Charles C. Ryrie, *Biblical Answers to Tough Questions*, ch. 7: "The Question of Suicide," pp. 87-94.

<sup>3</sup>Calvin, 2:8:39.

neighbor sacred. And if we do not wish to renounce all humanity, we ought to cherish his as our own flesh."<sup>1</sup>

### **The seventh commandment 20:14**

Adultery is sexual intercourse when one or both partners are married (or engaged, under Israelite law; cf. Deut. 22:23-29) to someone else. Adultery destroys marriage and the home, the foundations of society (cf. Matt. 5:27-28; 1 Cor. 6:9-20). Adultery is an act, not a state. People commit adultery; they do not live in adultery, except in the sense that they may continually practice it.

"The purpose of this commandment is: because God loves modesty and purity, all uncleanness must be far from us. To sum up, then: we should not become defiled with any filth or lustful intemperance of the flesh. To this corresponds the affirmative commandment that we chastely and continently regulate all parts of our life. But he expressly forbids fornication, to which all lust tends, in order through the foulness of fornication, which is grosser and more palpable, in so far as it brands the body also with its mark, to lead us to abominate all lust.

"... From this it is clear that any other union apart from marriage is accursed in his sight; and that the companionship of marriage had been ordained as a necessary remedy to keep us from plunging into unbridled lust [cf. 1 Cor. 7:9]. Let us not delude ourselves, then, when we hear that outside marriage man cannot cohabit with a woman without God's curse."<sup>2</sup>

Thomas Watson gave 16 helpful suggestions for avoiding adultery.<sup>3</sup>

### **The eighth commandment 20:15**

Since stealing of any kind and under any circumstances was wrong, it is clear that God approved of private ownership of goods in Israel. Israel was

---

<sup>1</sup>Ibid., 2:8:40.

<sup>2</sup>Ibid., 2:8:41.

<sup>3</sup>Watson, pp. 158-62.

somewhat socialistic economically, but it was not communistic (cf. Eph. 4:28).<sup>1</sup>

"The purpose of this commandment is: since injustice is an abomination to God, we should render to each man what belongs to him [Rom. 13:7]. To sum up: we are forbidden to pant after the possessions of others, and consequently are commanded to strive faithfully to help every man to keep his own possessions.

"We must consider that what every man possesses has not come to him by mere chance but by the distribution of the supreme Lord of all. For this reason, we cannot by evil devices deprive anyone of his possessions without fraudulently setting aside God's dispensation."<sup>2</sup>

"This command forbids us to rob ourselves of what we have by sinful spending, or of the use and comfort of it by sinful sparing, and to rob others by removing the ancient landmarks, invading our neighbour's rights, taking his goods from his person, or house, or field, forcibly or clandestinely, overreaching in bargains, not restoring what is borrowed or found, withholding just debts, rents, or wages, and (which is worst of all) to rob the public in the coin or revenue, or that which is dedicated to the service of religion."<sup>3</sup>

### The ninth commandment 20:16

Social order depends on truthful speech (cf. Lev. 19:11; Col. 3:9-10).

"The purpose of this commandment is: since God (who is truth) abhors a lie, we must practice truth without deceit toward one another. To sum up, then: let us not malign anyone with slanders or false charges, nor harm his substance by falsehood, in short, injure him by unbridled evilspeaking [*sic*] and impudence [cf. Exod. 23:1, 7; Lev. 19:11, 16] ... Surely there is no doubt that, as he forbade cruelty, shamelessness, and avarice in the preceding commandments, here he bars

---

<sup>1</sup>See McClain, pp. 75-81: "The Economical Aspect of the Historical Kingdom."

<sup>2</sup>Calvin, 2:8:45.

<sup>3</sup>Henry, pp. 94-95.

falsehood. ... For we must always come back to this: one particular vice is singled out from various kinds as an example, and the rest are brought under the same category, the one chosen being an especially foul vice. Yet it is more generally expedient to extend it to include slanders and perverse detraction by which our neighbors are unfairly hurt."<sup>1</sup>

### The tenth commandment 20:17

It is specifically what belongs to one's neighbor and is not for sale, contrasted with something for sale, that is the focus of this command. A desire is not necessarily the same thing as coveting, which is an obsessive desire. Coveting is a root attitude, from which spring many sins in word and deed against a neighbor (cf. Eph. 5:3).

"This desire for that which cannot lawfully be possessed is distinctly forbidden, and so this tenth word passes much deeper in its moral requirement than any that has preceded it."<sup>2</sup>

Note that the first and the tenth commandments deal with what is in the heart, while the other eight focus on actions that begin in the heart.<sup>3</sup> God wanted His people to turn away from evil thoughts, that, if they failed to turn away from, would naturally lead to evil actions. The categories of the most valuable possessions the neighbor could have ("wife," "male slave," "female slave," "ox," and "donkey") represent all that he has ("anything that belongs to your neighbor").

Were women free to covet their neighbor's husbands? I think not. As with many of God's commands, the male or husband is addressed, since he is the head of his wife and family. It is assumed that the command applies to the other members of the family.

"The purpose of this commandment is: since God wills that our whole soul be possessed with a disposition to love, we must banish from our hearts all *desire* contrary to love. To sum up, then: no thought should steal upon us to move our hearts to a harmful covetousness that tends to our neighbor's loss. To

---

<sup>1</sup>Calvin, 2:8:47.

<sup>2</sup>Morgan, *The Ten ...*, p. 109.

<sup>3</sup>Wiersbe, p. 223.



this corresponds the opposite precept: whatever we conceive, deliberate, will, or attempt is to be linked to our neighbor's good and advantage."<sup>1</sup>

Here are some concluding observations:

"Now it will not be difficult to decide the purpose of the whole law: the fulfillment of righteousness to form human life to the archetype of divine purity [cf. Lev. 11:44-45; 1 Pet. 1:16]."<sup>2</sup>

"... none of the Ten Commandments reappear in the New Testament for this age of grace *as Mosaic legislation*. All of the moral *principles* of the ten laws do reappear in the New Testament in a framework of grace."<sup>3</sup>

"The Christian must think through contemporary ethical issues with the Ten Commandments as a guide. How does the commandment not to steal apply to computer theft? How does the commandment not to kill apply to the abortion pill? Nuclear arms?"<sup>4</sup>

"The influence of the Ten Words on Western morality and law is beyond calculation. They have come to be recognized as the basis of all public morality."<sup>5</sup>

In view of this fact, it is especially tragic that it is now illegal to post a copy of the Ten Commandments in any American public school classroom.<sup>6</sup> A

---

<sup>1</sup>Calvin, 2:8:49. Italics are mine.

<sup>2</sup>Ibid., 2:8:51.

<sup>3</sup>Roy L. Aldrich, "The Mosaic Ten Commandments Compared to Their Restatements in the New Testament," *Bibliotheca Sacra* 118:471 (July 1961):257. I have added italicizing for emphasis. See also Charles C. Ryrie, "The End of the Law," *Bibliotheca Sacra* 129:495 (July-September 1967):239-47, for an excellent explanation of the Christian's relationship to the Ten Commandments. Mark Rooker, *Leviticus*, pp. 67-77, also included a good discussion of the New Testament and the Law.

<sup>4</sup>Longman and Dillard, p. 76.

<sup>5</sup>Ramm, p. 127.

<sup>6</sup>See Joyce G. Baldwin, "The Role of the Ten Commandments," *Vox Evangelica* 13 (1983):7-18, for a good synopsis of the role of the Decalogue as the Reformers and the Old Testament and New Testament writers saw it. Childs' commentary deals with the Decalogue in more detail than most others, on pp. 385-439, as does Davis', pp. 196-210. Ezekiel Hopkins wrote a classic explanation of the Decalogue in 1701 from the Puritan viewpoint that has been reprinted: "Understanding the Ten Commandments," in *Classical*

fuller exposition of the Ten Commandments follows in my notes on Deuteronomy 5.<sup>1</sup>

### 3. The response of the Israelites 20:18-21

The rest of this section contains the record of the Israelites' reaction to the giving of the Law, and God's reason for giving it as He did—with all the accompanying fearsome phenomena. God wanted the people to "fear" Him, and therefore "not sin" (v. 20).

"It can be argued that in the present shape of the Pentateuch, the Decalogue (Ex 20:1-17) is intended to be read as the content of what Moses spoke to the people upon his return from the mountain in 19:25. After the Decalogue, the narrative in 20:18-21 looks back once again to the people's fear in 19:16-24. In retelling this incident, the second narrative fills the important 'gaps' in our understanding of the first."<sup>2</sup>

Similarly, Genesis 2 retells the story of the Creation in Genesis 1, in order to fill in important gaps.

"The Book of the Covenant begins technically with Exodus 20:22, having been separated from the Decalogue by a brief narrative (vv. 18-21) describing the people's response to the phenomena accompanying Moses' encounter with Yahweh on Sinai (cf. 19:16-25). The technical term 'ordinances' (*mispatim*), which describes the specific stipulations of the covenant, does not occur until 21:1, so 20:22-26 serves as an introduction to the stipulation section. This introduction underlines Yahweh's exclusivity, His self-revelation to His

---

*Evangelical Essays in Old Testament Interpretation*, pp. 51-58. For a dispensational exposition of the Ten Commandments, see Steve Minter, "Ten Timeless Words (Exodus 20:1-17)," *Exegesis and Exposition* 1:1 (Fall 1986):67-80. For argumentation for the Mosaic origin of the Decalogue as opposed to a later origin, see Harold H. Rowley, "Moses and the Decalogue," *Bulletin of the John Rylands Library of the University of Manchester* 34:1 (September 1951):81-118.

<sup>1</sup>See also Lehman Strauss, *The Eleven Commandments*, for expositions of these 10 and Jesus' commandment to love one another in John 13:34.

<sup>2</sup>Sailhamer, *The Pentateuch ...*, pp. 56.

people, and His demand to be worshiped wherever He localizes His name and in association with appropriate altars."<sup>1</sup>

God evidently "spoke" the Ten Commandments in the hearing of all the Israelites (19:9; 20:19, 22)—accompanied with "thunder," "lightning flashes," "the sound of the trumpet," and "the mountain smoking" (v. 18)—in order to cause them to fear Him (v. 20). The people were so awestruck and frightened by this revelation that they asked Moses to relay God's words to them from then on ("Speak to us yourself," v. 19), which he did.

"This verse [v. 20] contrasts two types of 'fear': tormenting fear (which comes from conscious guilt or unwarranted alarm and leads to bondage) or salutary fear (which promotes and demonstrates the presence of an attitude of complete trust and belief in God; cf. the 'fear of the LORD God' beginning in Gen 22:12). This second type of fear will keep us from sinning and is at the heart of the OT's wisdom books (cf. Prov 1:7; Eccl 12:13 et al.)."<sup>2</sup>

"Whereas 19:16-24 looks at the people's fear from a divine perspective, 20:18-21 approaches it from the viewpoint of the people themselves. What we learn from both narratives, therefore, is that there was a growing need for a mediator and a priesthood in the Sinai covenant. Because of the people's fear of God's presence, they are now standing 'afar off' (20:21). Already, then, we can see the basis being laid within the narrative for the need of the tabernacle (Ex 25—31). The people who are 'afar off' must be brought near to God. This is the purpose of the instructions for the tabernacle which follow this narrative."<sup>3</sup>

#### **4. The stipulations of the Book of the Covenant 20:22—23:33**

"It is worth noting that the stipulations [conditions or requirements specified or demanded as part of an agreement]

---

<sup>1</sup>Merrill, "A Theology ...," p. 41.

<sup>2</sup>Kaiser, "Exodus," p. 427.

<sup>3</sup>Sailhamer, *The Pentateuch ...*, pp. 56-57.

are enfolded within matching frames that stress the exclusivity of Yahweh (Ex. 20:22-23; cf. 23:24-25, 32-33), His presence in specified places (20:24; cf. 23:14-17, 20, 28-31), and a proper protocol and ritual by which He may be approached by His servant people (20:24-26; cf. 23:18-19). It is within the context of a vertical covenant relationship, then, that the horizontal, societal, and interpersonal relationships of the Book of the Covenant take on their ultimate meaning."<sup>1</sup>

"The section before us has something to say about each of the ten commandments, even if only incidentally."<sup>2</sup>

### The basic principles of worship in Israel 20:22-26

God did not just condemn forms of worship that were inappropriate, but He instructed the Israelites positively on how they were to worship Him.

"The point of the section is this: those who worship this holy God must preserve holiness in the way they worship—they worship where he permits, in the manner he prescribes, and with the blessings he promises."<sup>3</sup>

This pericope serves as an introduction to 42 ordinances [pieces of legislation] in 21:1—23:12. A section similar to this introduction, following the 42 ordinances section, repeats the emphases of the introduction, and forms a conclusion to the judgments (23:13-19).<sup>4</sup>

Prohibition of idolatry (20:22-23)  Proper forms of worship (20:24-26)	42 ordinances (21:1—23:12)	Prohibition of idolatry (23:13)  Proper forms of worship (23:14-19)
--	-------------------------------	---

<sup>1</sup>Merrill, "A Theology ...," p. 41.

<sup>2</sup>Youngblood, p. 101.

<sup>3</sup>The NET2 Bible note on 20:22.

<sup>4</sup>Sailhamer, *The Pentateuch ...*, p. 289.

20:22-23 Verse 22 is a preamble and historical background for what follows. On the basis of God's revelation on the mountain, the Israelites were to obey Him as follows:

The Israelites were not to make idols representing gods other than Yahweh ("other gods besides Me"), nor were they to represent Yahweh by making idols to help them worship Him ("gods of silver or gods of gold," v. 23).

20:24-26 Yahweh permitted His people to build commemorative worship altars at the locations where He granted special theophanies, that is, manifestations of His presence.<sup>1</sup> These were in addition to the altars at Israel's central sanctuary (the tabernacle and later the temple; cf. Judg. 6:25-27; 13:15-20; 1 Sam. 9:11-14; 16:1-5; 1 Kings 18:30-40). They were to build these special altars—both for formal worship and for special occasions (e.g., Josh. 8:30; Judg. 6:25-26)—out of earth or uncut stone. The Canaanites used cut or dressed stones for their altars, and it was probably to distinguish the two that God directed Israel as He did.

Israel's altars were not to have steps, as many Canaanite altars did, so that the naked flesh of the priests would not be exposed as they mounted them to make their offerings.

"Possibly the verse intends to oppose the practice of certain peoples in the ancient East, like the Sumerians for instance, whose priests ... used to perform every ritual ceremony in a state of nakedness. Likewise the Egyptian priests ... used to wear only a linen ephod, a kind of short, primitive apron."<sup>2</sup>

One interpretation is that later on God allowed altars with steps to be built (Lev. 9:22; Ezek. 43:13-17), and the priests were instructed to wear linen undergarments (Exod. 28:40-42; Ezek. 44:18).<sup>3</sup>

---

<sup>1</sup>Marten H. Woudstra, *The Book of Joshua*, p. 166.

<sup>2</sup>Cassuto, p. 257.

<sup>3</sup>Kaiser, "Exodus," revised ed., p. 487.

"This simple description of true worship is intended to portray the essence of the Sinai covenant in terms that are virtually identical to that of the religion of the patriarchs—earthen altars, burnt offerings, and simple devotion rather than elaborate rituals. A simple earthen altar is sufficient. If more is desired (e.g., a stone altar), then it should not be defiled with carved stones and elaborate steps. The ultimate purpose of any such ritual is the covering of human nakedness that stems from the Fall (Ex 20:26b; cf. Ge 3:7). The implication is that all ritual is only a reflection of that first gracious act of God in covering human nakedness with garments of skin (Ge 3:21)."<sup>1</sup>

### The fundamental rights of the Israelites 21:1—23:12

It is very important to note that various law codes already existed in the ancient Near East before the giving of the Mosaic Covenant. These included the laws of the Akkadian civilization (located in Mesopotamia) in the twentieth century B.C. (e.g., the Laws of Eshnunna).<sup>2</sup> There were also the laws of the Sumerian civilization in the nineteenth century (e.g., the Code of Lipit-Ishtar).<sup>3</sup> Moreover the laws of the Babylonian civilization, that followed in the eighteenth century (e.g., the Code of Hammurabi),<sup>4</sup> still existed, as did others.<sup>5</sup> People living in the Near East at the time of the Exodus (fifteenth century) knew these laws, and lived by them, more or less.

"Continued use of Hammurabi's collection was possible for well beyond a millennium, since it was not a detailed code demanding constant amendment but was merely a list of key decisions whose precedents might be considered eternally valid."<sup>6</sup>

---

<sup>1</sup>Sailhamer, *The Pentateuch ...*, p. 289.

<sup>2</sup>Pritchard, pp. 161-63.

<sup>3</sup>*Ibid.*, pp. 159-61.

<sup>4</sup>*Ibid.*, pp. 163-80.

<sup>5</sup>See Finegan, *Light from ...*, pp. 53-62; Albright, *Archaeology and ...*, pp. 31.

<sup>6</sup>Olmstead, p. 121.

The Mosaic Covenant presupposes this cumulative body of legal literature. So it was not given as a comprehensive legal system to a people living without any laws. Rather, it was a series of instructions God gave—as Israel's King—for His people to govern their behavior in certain specific matters. This fact explains why the Torah (lit. "Instruction," i.e., the Law of Moses) does not contain fundamental instruction in many basic areas of law, such as monogamy. The instructions in the Law of Moses confirmed certain existing laws, cancelled other laws, and changed still others, for the Israelites, as the will of God for them.<sup>1</sup>

Moses revealed the laws that follow analogically (i.e., on the basis of the association of ideas). Analogical thinking has been more characteristic of Eastern cultures, and rational thinking more typical of Western cultures throughout history, generally speaking.

### Introduction 21:1

The ordinances in these chapters were not laws, in the usual sense of that word, but actually the rights of those living within Israel. The Book of the Covenant (20:22-23:33) was Israel's Bill of Rights.

"A selection of 'judgments' is provided as a sample of the divine judgments which Moses gave the people. A total of forty-two 'judgments' is given. [The 42 judgments appear in the following passages in Exodus: 21:2-6, 7-11, 12-13, 14, 15, 16, 17, 18-19, 20-21, 22-23, 24-26, 27, 28-32, 33-34, 35-36; 22:1-4, 5, 6, 7-9, 10-13, 14-15, 16-17, 18, 19, 20, 21, 22-24, 25-27, 28, 29-30, 31; 23:1, 2-3, 4, 5, 6, 7a, 7b, 8, 9, 10-11, 12.] The number forty-two apparently stems from the fact that the Hebrew letters in the first word of the section, 'and these' (*w'h*), add up precisely to the number forty-two (7 x 6). (There may also be a desire to have seven laws for each of the six days of work [cf. Ex 20:11]). This suggests that the laws in 21:1—23:12 are to be understood merely as a representative selection of the whole Mosaic Law. It is not an attempt at a complete listing of all the laws. The purpose of the selection was to provide a basis for teaching the nature of divine justice. By studying specific cases of the application of God's will in concrete situations, the reader of

---

<sup>1</sup>For further explanation, see Cassuto, pp. 257-64.

the Pentateuch could learn the basic principles undergirding the covenant relationship. Whereas the 'ten words' provided a general statement of the basic principles of justice which God demanded of his people, the examples selected here further demonstrated how those principles, or ideals, were to be applied to real life situations."<sup>1</sup>

### Slavery 21:2-6

21:2-4 The ancients practiced slavery widely in the Near East. These Mosaic laws protected slaves in Israel better than the laws of other nations protected slaves in those countries.<sup>2</sup>

We should read verse 4 with the following condition added at the end of the verse: "unless he pays a ransom for them." That this is a possible interpretation of the text is clear from the instructions regarding the redemption of people that follow (Lev. 25:25-28).

Why did God permit slavery at all? Slavery as a social institution becomes evil when others disregard the human rights of slaves. God protected the rights of slaves in Israel. Likewise, the Apostle Paul did not urge Philemon to set his slave Onesimus free, but to treat him as a brother (Philemon 15-17). As amended by the Torah, slavery became indentured servitude in Israel, for all practical purposes, similar to household servanthood in Victorian England. Mosaic law provided that male slaves in Israel should normally serve as slaves no more than six years, and then go free. In other nations, by contrast, slaves often remained enslaved for life.

"We can then conclude that Exodus 21:2-4 owes nothing to non-Biblical law. Rather it is a statement of belief about the true nature of Israelite society: it should be made up of free men. Economic necessities may lead an Israelite to renounce his true heritage, but his destiny is not in the end to be subject to purely financial

---

<sup>1</sup>Sailhamer, *The Pentateuch ...*, p. 290.

<sup>2</sup>See Robert Gnuse, "Jubilee Legislation in Leviticus: Israel's Vision of Social Reform," *Biblical Theology Bulletin* 15:2 (April 1985):44.



considerations. Exodus 21:2 is no ordinary humanitarian provision, but expresses Israel's fundamental understanding of its true identity. No matter how far reality failed to match the ideal, that ideal must be reaffirmed in successive legislation. So, in gradually worsening economic conditions both Deuteronomy (15:1-18) and the Holiness Code (Lev. 25:39-43) reiterate it. It is the male Israelite's right to release (Exod. 21:2-4) which explains why the laws of slavery (21:2-11) head that legislation which sought to come to terms with Israel's new found statehood with all its consequent economic problems under the united monarchy."<sup>1</sup>

Presumably female as well as male slaves could experience redemption from their condition at any time.

21:5-6 The Code of Hammurabi decreed that the master of a rebellious slave could cut off the ear of that slave. So the condition of the ear (v. 6)—whether intact, pierced, or missing—evidently marked the status of a slave in the ancient Near East (cf. Ps. 40:6). By boring the ear with an awl against a door or doorpost, the master symbolized that the servant was permanently attached to the house (household).

### **Betrothal of a female 21:7-11**

Females did not enjoy as much freedom as males in the ancient Near East or in Israel. They were subject to the fathers or husbands in authority over them, as well as to God (cf. Eph. 5:22-24; Col. 3:18). Verses 7-11 describe a girl whom her father sells as a "slave" (Heb. *'amah*, v. 7) for marriage, not for *slavery*.<sup>2</sup> In such a case, the girl would become the "slave" (or maid) of the father of her husband-to-be, who would then give ("designate," v. 8) her to his son *as his wife*. She would remain in her prospective father-in-law's household, unless or until someone redeemed her before the consummation of her marriage. If, for some reason, her prospective father-

---

<sup>1</sup>Anthony Phillips, "The Laws of Slavery: Exodus 21:2-11," *Journal for the Study of the Old Testament* 30 (October 1984):62.

<sup>2</sup>Kaiser, "Exodus," p. 430.

in-law became displeased with her, he was to allow someone to redeem her (set her free by the payment of a price). Her "redeemer" could be herself or someone else (cf. Deut. 24:1). Her master was not to sell her like a slave to some other person—a "foreign" person in that sense (v. 8). Such treatment would be unfair to her, because it would have violated her legitimate human rights. "Conjugal (or marital) rights" (v. 10) here refers to her living quarters and other support provisions, not sexual intercourse. This passage is not discussing marriage as such (after physical consummation)—as the AV translation "duty of marriage" implies.

### **Homicide 21:12-17**

21:12-14 The Torah upheld capital punishment for murder (v. 12), which God commanded of Noah (Gen. 9:6). People in the Near East practiced it from Noah's day on. Moses' law did not permit capital punishment in the case of manslaughter (unpremeditated murder, v. 13), which the Code of Hammurabi allowed.<sup>1</sup>

In the ancient East, whoever sought sanctuary in a sacred place was safe from punishment, even if he or she had deliberately murdered someone. The Torah removed that protection in the case of murder. God regarded the sanctity of human life greater than the sanctity of a place.

21:15-17 The Code of Hammurabi specified that the person who struck his father should have his hands cut off.<sup>2</sup> The Torah took a stronger position, requiring the death of the person who struck either parent. The reason for the death penalty seems to be that, by striking his or her parent, the striker did not honor the parent, but had revolted against God's ordained authority over him or her (v. 15; cf. 20:12).

"In the first place age is not a factor in the determining of a delinquent in the ancient Near East: age is never mentioned in the [non-biblical] texts. A minor, for all intents and purposes, was one who was living in his or her parent's house.

---

<sup>1</sup>Code of Hammurabi, section 229, in Pritchard, pp. 163-80.

<sup>2</sup>Ibid., section 195.

There he or she has duties and responsibilities which place him directly under the authority of the parent. Responsibility for a minor's behavior rested solely with the parent. Any anti-social act committed by the minor was considered also an offense against the parent who dealt with it accordingly. When proceedings are initiated against a minor, as we shall see, it is the parent, not the courts, who institutes the proceedings. ...

"In ancient times no provision was made for a minor committing a criminal act, that is, there was no special protection extended to juveniles convicted in criminal cases: the penalty for both an adult and a minor was the same. This represents a striking difference from our judicial system whereby a minor is not held to be as criminally responsible for his conduct as an adult. In effect he is granted a certain amount of protection by the courts, and his sentence is not as severe as an adult's would be in a similar case. It is curious that in the few examples we have of felonies committed by minors in the ancient Near East the opposite situation prevails. A minor receives a more severe sentence than an adult would in a comparable case. ...

"At this point we should not get too exercised over whether or not these punishments were ever carried out. It is considered today most unlikely that these types of punishments, or talionic punishment in general, were ever put into practice in the ancient Near East.<sup>1</sup> What is important here is the severity accorded these offenses in the light of other offenses listed in the same legal corpus. It is most significant that in both cases the assault is against a parent. Assault against another person would subject the minor to a lesser penalty. In Mesopotamian law a minor striking

---

<sup>1</sup>*Encyclopaedia Judaica*, s.v. "Cuneiform Law," by J. Finkelstein, 16:1505i.

someone other than his parent would not have his hand cut off; depending on his status he would be fined or flogged.<sup>1</sup> Likewise, in ancient Israel he would be fined and not subject to the death penalty (Exod. 21:18-19). Thus we have a situation where striking a non-parent makes one subject to regular criminal law, but striking a parent makes one subject to a 'juvenile delinquent' law which carries a more severe penalty."<sup>2</sup>

Kidnapping was also a capital offense (v. 16; 20:15; Gen. 37:28), as was cursing (verbally dishonoring) one's parents (v. 17; cf. 20:12). Verse 15 deals with a criminal offense, but verse 17 describes a civil offense (cf. Lev. 20:9; Deut. 27:16; Prov. 20:20; 30:11). Marcus went on to distinguish this type of offense as follows:

"Turning now to non-criminal acts, civil or status offenses, we review the salient points of the modern definition of a juvenile delinquent as one who is incorrigible, ungovernable, or habitually disobedient. The operative word in most modern definitions is 'habitual.' An isolated occurrence does not make a child delinquent. Note that the New York State definition speaks of the child as being 'habitually disobedient,' and the California one terms the delinquent as one who 'habitually refuses to obey.' We shall see that a number of ancient Near Eastern legal texts make this distinction as well. This is important because it enables us to distinguish what is clearly delinquency from what is only what we call 'generation gap' disagreements. The ancients

---

<sup>1</sup>Code of Hammurabi, sections 202-4.

<sup>2</sup>David Marcus, "Juvenile Delinquency in the Bible and the Ancient Near East," *Journal of the Ancient Near Eastern Society of Columbia University* 13 (1981):32-34.

were well aware of this generation gap between parents and children."<sup>1</sup>

All of the crimes in verses 12 through 17 were worthy of death, and were serious in God's eyes. They either violated a basic right of a human being created in God's image, or were expressions of rebellion against God's revealed authority in the home, the basic unit of society.

"Life, in essence, is the property of God; the possession of it is leased to human beings for a number of years. This lease can be extended or contracted in accordance with God's will. (Cf. 1 Kings 21:27-29; 2 Kings 20:1-6; Job 1:12-19.) When a man arrogates to himself the right of ownership in the life of human beings and interferes with the right of enjoyment of life by taking it away—that is, killing it—he has violated one of the essential laws of God and therefore forfeits his own right to the possession of life."<sup>2</sup>

### **Bodily injuries 21:18-32**

Moses cited five ordinances in this section, as was true in the preceding one (vv. 12-17).

21:18-19 The Torah made no distinction in the penalty assessed based on an aggressor's intentions (vv. 18-28). Striking another person was wrong regardless of the reason for doing so. The inferior Hammurabi Code adjusted the penalty, by permitting the assailant to pay less damage if he claimed no intent to cause injury.<sup>3</sup>

21:20-21 As with other people, slaves also enjoyed protection from murderers (v. 20; cf. v. 12). However, the slave owner likewise experienced protection from execution, if his punishment of a slave was not the direct cause of the slave's death. In such a

---

<sup>1</sup>Ibid., pp. 35-36. For an evaluation of modern American penal philosophies in the light of the Mosaic Law, see Gary R. Williams, "The Purpose of Penology in the Mosaic Law and Today," *Bibliotheca Sacra* 133:529 (January-March 1976):42-55.

<sup>2</sup>Davis, p. 221.

<sup>3</sup>Code of Hammurabi, section 206.

case, the law regarded the loss of the slave as sufficient punishment of the master (v. 21).

21:22 Manslaughter of an unborn child carried a fine (v. 22). The reason seems to have rested on two assumptions: First, accidental killing is not as serious a crime as deliberate killing. Second, a fetus, though a human life, does not have the same status as a self-sufficient human being.<sup>1</sup>

"The most significant thing about abortion legislation in Biblical law is that there was none. It was so unthinkable that an Israelite woman should desire an abortion that there was no need to mention this offense in the criminal code."<sup>2</sup>

Pro-abortion advocates frequently appeal to verse 22 to support their claim that a fetus is not a person and, therefore, abortion is not murder. One example of this follows:

"In other words, if you cause the death of the fetus, you merely pay a fine; if you cause the death of the woman, you lose your own life. Thus the Bible clearly shows that a fetus is *not* considered a person. If the fetus were considered to be a person, then the penalty for killing it would be the same as for killing the woman—death. Abortion, then, is *not* murder."<sup>3</sup>

---

<sup>1</sup>See Sandra Lubarsky, "Judaism and the Justification of Abortion for Non-Medical Reasons," *Journal of Reform Judaism* 31:4 (Fall 1984):1-13, which contains helpful information on the rabbinic teaching on abortion, though the author's conclusion, "... Judaism not only permits abortions for medical reasons, but also supports abortion for non-medical reasons" (p. 12), contradicts the spirit of Old Testament teaching.

<sup>2</sup>Meredith Kline, "*Lex Talionis* and the Human Fetus," *Simon Greenleaf Law Review* 5 (1985-86):75. See also Josephus, *Against Apion*, 2:25; Bruce K. Waltke, "Reflections from the Old Testament on Abortion," *Journal of the Evangelical Theological Society* 19:1 (Winter 1976):3-13; Robert N. Congdon, "Exodus 21:22-25 and the Abortion Debate," *Bibliotheca Sacra* 146:582 (April-June 1989):132-47.

<sup>3</sup>Graham Spurgeon, "Is Abortion Murder?" in *The Religious Case for Abortion*, p. 16. For the same view, see also Shalom Paul, *Studies in the Book of the Covenant in the Light of Cuneiform and Biblical Law*, p. 71; Lloyd Kalland, "Fetal Life," *Eternity*, February 1971, p. 24; Dolores E. Dunnett, "Evangelicals and Abortion," *Journal of the Evangelical Theological Society* 33:2 (June 1990):217.

However, other Scriptures present the fetus as a person, a real human being (Job 10:8-12; 15:14; Ps. 51:5; 58:3; 139:13-16; Eccles. 11:5; Jer. 1:5; Gal. 1:15). This was the prevailing opinion in the ancient Near East as well.<sup>1</sup>

In contrast to other ancient Near Eastern law codes, the Torah made no differentiation on the basis of the woman's social class. It treated all women equally. Also, only the man who caused the injury to the woman was liable, not other members of his family, who could suffer punishment for his offense, and often did, in other ancient Near Eastern societies. Principles explained elsewhere in the Torah determined the amount of penalty the guilty party had to pay.<sup>2</sup>

21:23-25 God intended the "eye for eye" provision to *limit* punishment, rather than to give free reign to it. The "law of retaliation" (Latin *lex talionis*) became common in the ancient Near East. It sought to control the desire to take revenge in someone who had only suffered a minor injury but wanted to take major revenge. For example, a man might want to kill the person who beat up his brother (cf. Gen. 4:23). God forbade such excessive vengeance among His people, and was limiting their actions, so that they would only exact equal compensation for offenses committed against them—and no more.<sup>3</sup>

"This law of the talion, for a long time thought to be a more primitive kind of penalty, the reflection of a barbaric law form, has been shown by more recent comparative studies to be a later development, designed to remedy the inevitable

---

<sup>1</sup>See the excellent discussion by Russell Fuller, "Exodus 21:22-23: The Miscarriage Interpretation and the Personhood of the Fetus," *Journal of the Evangelical Theological Society* 37:2 (June 1992):169-84. Fuller also evaluated and rejected the popular evangelical view that this verse does not refer to a miscarriage but to a premature birth. See also Ryrie, *Biblical Answers ...*, ch. 8: "The Question of Abortion," pp. 95-104.

<sup>2</sup>See Stanley Isser, "Two Traditions: The Law of Exodus 21:22-23 Revisited," *Catholic Biblical Quarterly* 52:1 (January 1990):30-45, for some ancient abortion laws and the views of Jewish rabbis and translators on this passage.

<sup>3</sup>See J. Kirby Anderson, *Moral Dilemmas*, ch. 6: "Crime and Punishment," for information about crime and punishment in America.

abuses made possible by monetary payment for physical injury."<sup>1</sup>

"It is one of the cruel features of the *lex talionis* [as applied outside the Mosaic Law], that if the real murderer can not [*sic*] be reached, the avengers of blood have a right to kill any other member of the family, then any relation, no matter how remote, and, finally, any member of this blood confederation."<sup>2</sup>

"According to Num. xxxv 31 it is only from a willful murderer that it is forbidden to accept ransom [payment in place of punishment]; this implies that in all other instances the taking of a ransom is permitted. ... This being so, the meaning here in our paragraph of the expression *life for life* [v. 23] is that the one who hurts the woman accidentally shall be obliged to pay her husband the value of her life if she dies, and of her children if they die."<sup>3</sup>

21:26-27 In contrast to verse 27, the Code of Hammurabi prescribed that, in a case of bodily injury to a slave, the offender had to pay the slave's master half the price of the slave.<sup>4</sup> If a master blinded his own slave, Hammurabi's code required no penalty. The Torah, on the other hand, shows greater concern for the slave. This law would have discouraged masters from physically abusing their slaves.

21:28-32 The Hammurabi Code specified the death of the ox owner's son, if the ox killed the son of another man (v. 31).<sup>5</sup> The Torah required the owner's life or else just a ransom (v. 30), depending on the ox's previous tendencies.

Note, too, that verses 31 and 32 value the lives of male and female slaves the same. The value of an adult slave under the

---

<sup>1</sup>Durham, p. 324.

<sup>2</sup>W. M. Thomson, *The Land and the Book*, 1:448.

<sup>3</sup>Cassuto, p. 277. Paragraph division omitted.

<sup>4</sup>Code of Hammurabi, section 199.

<sup>5</sup>*Ibid.*, section 230.



Torah was 30 shekels of silver (cf. Matt. 26:15). Under the Code of Hammurabi, it was one third of a mina of silver (about 17 shekels).<sup>1</sup> The ox also died by stoning. With this law, God was teaching His people that they should view even slaves as created in His image (cf. Gen. 9:5).

The goring ox (vv. 28-32) is the typical example of death caused by cattle or domestic animals.

"The fate of the ox gives clear evidence of the theological principle of the subordination of the animal world to human sovereignty. That the fatal goring of one ox by another required only compensation shows the relative insignificance of the animal-to-animal relationship (vv. 35-36)."<sup>2</sup>

### **Property damage 21:33—22:15**

21:33-34 The pit causing accidental injury or death represents a typical case of damage caused by an inanimate object or natural danger. These specific cases in these verses doubtless served as precedents for other similar cases.

"Mischievous done in malice is the great transgression; but mischief done through negligence is not without fault."<sup>3</sup>

"I have been astonished at the recklessness with which wells and pits are left uncovered and unprotected all over this country [i.e. ancient Canaan]. It argues a disregard of life which is highly criminal. I once saw a blind man walk right into one of these unprotected wells. He fell to the bottom, but, as it was soft sand, he was not so much injured as frightened."<sup>4</sup>

---

<sup>1</sup>Ibid., section 252.

<sup>2</sup>Merrill, "A Theology ...," p. 43.

<sup>3</sup>Henry, p. 96.

<sup>4</sup>Thomson, 1:519.

21:35-36 The law concerning cattle or oxen that fight is the same as one in the Laws of Eshnunna, a twentieth century B.C. Akkadian law code.<sup>1</sup> However, the Torah differentiated between an ox that gored habitually, and one that did not, in the case of one ox goring another. Thus the Torah showed higher regard for the rights and responsibilities of individuals.

22:1-4 According to the Code of Hammurabi, a thief should be executed if he could not repay what he had stolen,<sup>2</sup> or if he stole by breaking in.<sup>3</sup> The Torah modified this law by annulling the death penalty, and substituted, in its place, the penalty of being sold into slavery, in the first case. In the second case, where the thief breaks in, the Torah annulled the death penalty and protected the life of the victim, counting him innocent, because he was simply defending his home and property. The second case actually involves two cases in the Torah: the second case, where the thief is killed, and a third case, where the thief is injured but survives.

Verses 1 and 4 of chapter 22 go together, and deal with theft generally. The reason for the harsh fivefold (in the case of oxen) and fourfold (in the case of sheep) penalties, appears to be that the thief was taking the means of another person's livelihood.<sup>4</sup>

Verses 2 and 3, which deal with breaking and entering, address a special type of theft: burglary. Perhaps the law assumed that the burglar's intent was murder as well as theft, if he broke in at night, but only theft if he broke in in daylight. If so, we might assume that, if his intentions turned out to have been otherwise, the law would deal with him accordingly. The text gives only the typical case. Perhaps the logic was that at night, the victim's life was in greater danger, so the law allowed him to use more force in resisting his assailant than in the daytime.

---

<sup>1</sup>Laws of Eshnunna, section 53.

<sup>2</sup>Code of Hammurabi, section 8.

<sup>3</sup>Ibid., section 21.

<sup>4</sup>Kaiser, "Exodus," p. 436.

22:5-6 Another case of property rights violations involves damage due to grazing animals or burning. In the first instance (v. 5), the Torah required restitution from the best of the offender, whereas the Code of Hammurabi required only restitution.<sup>1</sup> These two examples further illustrate God's respect for the rights of others.

22:7-15 Next we have four cases involving property held in custody. In the Hammurabi Code, the penalty for losing or allowing a thief to steal what someone else had committed to one's trust, was death,<sup>2</sup> as was falsely accusing someone of this crime.<sup>3</sup> The Torah required only twofold payment in both situations (v. 9).

Second, if what someone entrusted to his neighbor for safekeeping perished by accident (vv. 10-13), the neighbor was not responsible to make restitution. The law was the same under the Code of Hammurabi.<sup>4</sup>

Third, if someone borrowed something, and it then suffered damage or it died (v. 14-15a), the borrower was responsible to make restitution. This was the procedure, unless the owner (lender) was present when the damage or death took place. In that case, the lender was responsible for his own property.

Fourth, if someone rented something and then damaged it, or it died (v. 15b), the borrower was not responsible to make restitution, since the fee he had paid covered his liability. The Code of Hammurabi specified no liability in either of these last two instances.<sup>5</sup>

### **Crimes against society 22:16-31**

22:16-17 Next we have a case of consensual sexual intercourse resulting from seduction. Here the girl is viewed as the property of her father. If a young couple had premarital sex, the young man had to marry the young woman, and give his future father-in-

---

<sup>1</sup>Code of Hammurabi, section 57.

<sup>2</sup>*Ibid.*, section 9.

<sup>3</sup>*Ibid.*, section 11.

<sup>4</sup>*Ibid.*, sections 263-67.

<sup>5</sup>*Ibid.*, section 249.

law the customary payment (i.e., a dowry) in order to marry her. The girl's father could refuse this offer, however, in which case the boy would not get to marry the girl, but he would still have to pay the dowry. This law pertained to situations in which seduction (persuasion), not rape, had resulted in intercourse. Other Torah passages indicating that premarital sex is sinful include Genesis 2:24 and Deuteronomy 22:13-29. Moses did not deal with other similar situations here. Israel was evidently to function in harmony with previously existing law in these cases.<sup>1</sup>

"As many scholars recognize, the second half of the Book of the Covenant begins at Exodus 22:18 and the stipulations undergo a change in content to match what is clearly a change in form. The first half (Ex. 20:22—22:17) is fundamentally casuistic, whereas the latter half [22:18—23:33] is not.<sup>2</sup> That is, the stipulations now are expressed as prescriptions or prohibitions with little or no reference to the penalty attached to violation in each case."<sup>3</sup>

22:18-20 God prohibited three more practices, each of which brought the death penalty. All three involve idolatry.

In the ancient world, people made a distinction between black and white magic. The former sought to harm someone, and the latter did not. The Hammurabi Code prohibited the former only,<sup>4</sup> but the Torah outlawed both types of witchcraft, without distinction. Witchcraft (or sorcery) constituted an attempt to override God's will.<sup>5</sup> Probably Moses mentioned only the sorceress (v. 18), because women at that time were

---

<sup>1</sup>Cassuto, pp. 288-89.

<sup>2</sup>Childs, p. 477.

<sup>3</sup>Merrill, "A Theology ...," p. 44.

<sup>4</sup>Code of Hammurabi, section 2.

<sup>5</sup>See Jan Karel Van Baalen, *The Chaos of Cults*, pp. 20-50.

particularly active in the practice of sorcery. Probably the law would have dealt with a sorcerer the same way.<sup>1</sup>

Having intercourse with animals ( v. 19) was something the Canaanites and Mesopotamians attributed to their gods, and which they practiced when worshipping those gods. Whereas some Near Eastern law codes imposed the death penalty for having intercourse with certain animals, the Torah prohibited this practice completely, covering any and all animals.

The third ordinance (v. 20) prohibited offering sacrifices to any false god.

22:21-27 The next collection of laws deals with various forms of oppression. The first section concerns care and concern for the poor and needy. While the Israelites were not to tolerate the idolatrous customs of foreigners, they were to manifest practical love toward non-Israelites ("strangers") particularly, as well as toward the poor and needy ("widow or orphan") generally. The Israelites were to remember the oppression they had endured in Egypt, and were consequently to refrain from oppressing others. They were not only to refrain from doing evil, but were to do them positive good (cf. Matt. 5:44; Rom. 12:14).

The Israelites could lend money to fellow Israelites, but they were not to charge them interest on the loan (v. 25). If they took a neighbor's cloak as collateral on a loan, they had to return it to him before sunset, since he would normally need it to keep warm at night (vv. 26-27).

22:28 This verse urges reverence toward God and the leaders of the community. Having dealt with proper behavior toward people on a lower social level, God also specified how to deal with those on higher levels of authority.

22:29-30 The law for first-fruits required the Israelites to offer several offerings to the LORD: their sons, animals, and crops. Perhaps the purpose of allowing animals to stay with their mothers for

---

<sup>1</sup>See Roy B. Zuck, "The Practice of Witchcraft in the Scriptures," *Bibliotheca Sacra* 128:512 (October-December 1971):352-60.

the first seven days of their lives was to allow them to develop safely.<sup>1</sup> It may also have been to give natural relief to the dam's mammary glands by suckling its offspring.<sup>2</sup>

22:31 Animal "flesh torn ... in the field" was both unsuitable and, from then on, unlawful for Israelite consumption. Not only might the animal have died from a communicable disease, but second-rate food like this was inappropriate for a people set apart to a holy God. Furthermore, the blood had not been drained from such an animal (cf. Lev. 3:17).

### Justice and neighborliness 23:1-9

This section addresses justice toward all people. The subject of the legislation now shifts from love for all to justice for all. The Israelites should treat all people justly, not only the rich but also the poor (v. 3), the enemy as well as the friend (v. 4). Jezebel later did to Naboth what verse 7 warns against (cf. 1 Kings 21:9-14).

"If we must bring back our neighbours' cattle when they go astray [v. 4], much more must we endeavor, by prudent admonitions and instructions, to bring back our neighbours themselves, when they go astray in any sinful path, see Jam. V. 19, 20. And, if we must endeavor to help up a fallen ass, much more should we endeavor to help up a sinking spirit, *saying to those that are of a fearful heart, Be strong.*"<sup>3</sup>

### Rest 23:10-12

"Till now the text dealt with positive and negative precepts that are valid at all times; now we have a series of precepts that are to be observed at given times, commandments that apply to seasons that are specifically dedicated to the service of the Lord, and are intended to remind the Israelites of the covenant that the Lord made with them, and of the duty resting upon them to be faithful to this covenant."<sup>4</sup>

---

<sup>1</sup>Durham, p. 330.

<sup>2</sup>Kaiser, "Exodus," p. 440.

<sup>3</sup>Henry, p. 97.

<sup>4</sup>Cassuto, p. 300.

23:10-11 The people were to observe the sabbatical year (cf. Lev. 25:2-7; Deut. 15:1-3). The Israelites' failure to observe 70 sabbatical years, which amounted to 490 consecutive years without rest, resulted in God removing Israel from the Promised Land to Babylon—for 70 years—to give the land its rest (2 Chron. 36:20-21).

"... it may be desirable briefly to refer to the observance of the Sabbatical year, as it was strictly enforced at the time of Christ. It was otherwise with the year of Jubilee."<sup>1</sup>

23:12 God intended Sabbath observance to give His people, and even their laboring animals, needed rest.

### The reiteration of basic principles of worship 23:13-19

23:13 This verse is a summary warning against idolatry. Even discussing other gods was forbidden (cf. 20:22-23).

"The continual return to the theme of idolatry throughout this section of the book is preparation and background for an appreciation of the incident of the golden calf (Ex 32)."<sup>2</sup>

23:14-17 All the male Israelites had to make a pilgrimage to the sanctuary (tabernacle) three times a year, for the feasts of Unleavened Bread, Harvest of the First Fruits (also called Weeks and Pentecost), and Ingathering (also called Booths and Tabernacles). Women and children would have normally accompanied the males on the tri-yearly pilgrimages. This requirement fostered the maintenance of the national and social unity of the 12 tribes of Israel, as well as their spiritual unity.

23:18 "The first part of this verse has nothing to do with eating anything leavened. Rather it means that individual Israelites were not to kill the Passover lamb while leaven was still in their houses. The

---

<sup>1</sup>Edersheim, p. 189. Cf. Josephus, *Antiquities of ...*, 13:8:1.

<sup>2</sup>Sailhamer, *The Pentateuch ...*, p. 293.

second half of the verse makes no reference to fat as such; but as the parallel verse in 34:25b says, the 'sacrifice from the Passover Feast' (here lit., 'sacrifice of my feast') shall not 'remain until morning' (cf. 12:10)."<sup>1</sup>

The "fat" means the best part, here referring to the whole sacrifice.

23:19 The commentators have accounted for the prohibition against boiling a kid (a young lamb or goat) in its mother's milk in many different ways. Some scholars believe it was the opposition to commingling life with death, a source of life with its product, or Israel with the nations, that was the basis for this prohibition (cf. Lev. 22:27-28; Deut. 22:6).<sup>2</sup> Another view is that it was a way of specifying that only weaned animals were acceptable as sacrifices (cf. 34:18-26).<sup>3</sup>

"Many of the Mosaic precepts are evidently designed to cultivate gentle and humane feelings; but 'kid in his mother's milk' is a gross, unwholesome dish, calculated also to kindle up animal and ferocious passions, and, on these accounts, Moses may have forbidden it. Beside, it is even yet associated with immoderate feasting, and originally, I suspect, was connected with idolatrous sacrifices."<sup>4</sup>

Other scholars argued that it was: "A prohibition against imitating the superstitious rites of the idolaters in Egypt, who, at the end of their harvest, seethed a kid in its mother's milk and sprinkled the broth as a magical charm on their

---

<sup>1</sup>Kaiser, "Exodus," p. 445.

<sup>2</sup>Jacob Milgrom, "'You Shall Not Boil a Kid in Its Mother's Milk,'" *Bible Review* 1:3 (Fall 1985):48-55; Merrill, in *The Old ...*, p. 63.

<sup>3</sup>Sailhamer, *The Pentateuch ...*, p. 294.

<sup>4</sup>Thomson, 1:135.



gardens and fields, to render them more productive the following season."<sup>1</sup>

The most popular explanation is that this was a pagan practice that showed disrespect for the God-given relationship between parent and offspring.<sup>2</sup> The Ras Shamra tablets have shown that boiling sacrificial kids in their mother's milk was a common ritual practice among the Canaanites.<sup>3</sup> This view has been refuted effectively, however.<sup>4</sup>

This ordinance is the basis for the separation, that strict Jews make in their kosher diet—of not mixing dairy and meat products. Observant Jews even today provide separate equipment and kitchens for the preparation of these dishes.

### Yahweh's relation to Israel 23:20-33

In this final part of the Book of the Covenant, God gave the Israelites promises and precepts relating to their conquest of the Promised Land. Suzerainty treaties normally concluded with an explanation of the benefits that would come to the vassals if they obeyed the king's commands, and the difficulties they would experience if they disobeyed. That is characteristic of this section of the covenant, though the emphasis is positive.

"Similar opening [20:22-26] and closing remarks are also found in the codes of Hammurabi and Lipit-Istar."<sup>5</sup>

"Following the text of the covenant code Yahweh assures His people of His ongoing commitment. He had not brought them out of Egypt and made covenant with them only to forget them in the wilderness. He had promised to give them land, so now He speaks of the process by which they would enter the

---

<sup>1</sup>Jamieson, et al., p. 72.

<sup>2</sup>E.g., Meyer, p. 270.

<sup>3</sup>See Charles F. Pfeiffer, *Ras Shamra and the Bible*. See also Henry, p. 98.

<sup>4</sup>See Jacob Milgrom, *Leviticus 1—16*, pp. 737-38. For other views, see Kaiser, "Exodus," p. 445.

<sup>5</sup>Cassuto, p. 305.

land and the circumstances they would face there (Ex. 23:20-33)."<sup>1</sup>

- 23:20-23 God stressed the importance of obedience in these verses. The angel referred to, also called "My angel" (v. 23), was undoubtedly "the angel of the LORD" (cf. Josh. 5:13-15).
- 23:24-26 Moses again stressed the worship of the true God as opposed to the gods of "the Canaanites. Note the repeated emphasis on obedience and worship also in verses 20-26."<sup>2</sup>
- 23:27-28 God promised His people various provisions if they would be obedient. We should probably understand the "hornets" (v. 28) figuratively, though some interpreters take them literally (cf. Deut. 7:20; Josh. 24:12).<sup>3</sup> There is no reference in the text to God using real hornets to drive out the Canaanites, but He did use other hornet-like forces.

"Perhaps 'the hornet' is a symbol of Egypt, just as Isaiah 7:18 uses the 'fly' and the 'bee' as symbols of Egypt and Assyria, respectively."<sup>4</sup>

- 23:29-30 God told the Israelites that they would not drive out all their enemies in a single year, probably referring to the first year after they entered the land (v. 29). They did not do so. Israel was less successful than she might have been, due to incomplete obedience.

"'Little by little' does the work of God proceed through the individual soul. 'Little by little' do the conquests of the Cross win over the world. 'Little by little' is the unfolding purpose of Redemption made manifest to men and angels."<sup>5</sup>

---

<sup>1</sup>Merrill, "A Theology ...," p. 47.

<sup>2</sup>On the promise that God would give the Israelites good health, see my comments on 15:26.

<sup>3</sup>E.g., Wiersbe, p. 393.

<sup>4</sup>Kaiser, "Exodus," p. 447.

<sup>5</sup>Meyer, pp. 281-82.

- 23:31 God further promised a wide "boundary" or land area. It stretched from the Red Sea (probably the Gulf of Aqabah, the southeastern boundary) to the Mediterranean Sea (the western boundary). It also ran from the wilderness (probably the northeast edge of the Sinai wilderness, the southwest boundary) to the Euphrates River (the northeastern boundary; cf. Gen. 15:18). Some writers believed that this is a reference to the river that now forms the border between modern Lebanon and Syria.<sup>1</sup> Yet in the Hebrew Bible, "the river" or "the great river" usually refers to the Euphrates. Israel did not occupy all of this territory due to her incomplete obedience to God.
- 23:32-33 These verses contain a final warning. Israel was to make no covenants with the Canaanites or their gods, because she already had a covenant with Yahweh. The Israelites failed here too (e.g., Josh 9:3-15).

"The Decalogue begins with the command that Israel have no god other than Yahweh. The Book of the Covenant begins (20:23) and ends (23:32-33) with that same command, and all that lies between that beginning and that ending is designed to assure its obedience."<sup>2</sup>

It is very important to observe that God conditioned obtaining all that He promised the Israelites as an inheritance on their obedience. They could only enter into all that He promised by obeying God. Their inheritance, like some of the Christians' future rewards, was something different from their salvation, which came to them—as it does to Christians—only by faith in God (Gen. 15:6; Exod. 12:13; 14:31). The New Testament, likewise, teaches that justification comes solely by faith in God, but only obedient Christians will obtain the full inheritance (reward) that God has promised them (cf. Heb. 3:12—4:14).<sup>3</sup>

---

<sup>1</sup>E.g., Kaiser, "Exodus," p. 447.

<sup>2</sup>Durham, p. 337.

<sup>3</sup>For a good explanation of the Old and New Testament teaching on the subject of the believer's inheritance, see Joseph C. Dillow, *The Reign of the Servant Kings*, pp. 43-110.

## 5. The ratification of the Covenant 24:1-11

"The great event in chapter 24 is the climax of the Book of Exodus."<sup>1</sup>

24:1-8 The verses in this section contain God's directions to Moses personally. First, Moses, Aaron, Aaron's two oldest sons, Nadab and Abihu, and 70 of the elders of Israel were to ascend the mountain to worship God—"at a distance" (v. 1). Then God permitted only Moses to approach Him closely, however (v. 2).

Moses first related the content of God's covenant with Israel orally, and the people submitted to it. The people promised to do all that God commanded them (v. 3; cf. 19:8). (Incredibly, Josephus wrote: "... the Hebrews did not transgress any of those laws ..." <sup>2</sup>) Then Moses wrote down God's words in order to preserve them permanently for the Israelites (v. 4). The altar that he "built memorialized the location for all time as the place where God had revealed Himself to His people. The 12 memorial stones (v. 4) were probably not part of the altar, but separate from it. They probably represented the unique, permanent relationship that the 12 tribes had with God, which God Himself established when He made this covenant.

"In the ceremony to be performed, the altar will represent the glory of the Lord, whilst the pillars will represent the tribes of Israel; the two contrasting parties will stand facing each other."<sup>3</sup>

The 12 memorial stones may also have been "standing stones" to commemorate the occasion (cf. Gen. 31:45).<sup>4</sup> The young men (v. 5) were probably assistants to Moses, chosen for this special occasion to serve as priests, since they offered burnt offerings and sacrificed young bulls (cf. 19:22, 24).

---

<sup>1</sup>Ramm, p. 139.

<sup>2</sup>Josephus, *Antiquities of ...*, 3:8:10.

<sup>3</sup>Cassuto, p. 311.

<sup>4</sup>John W. Hilber, "Theology of Worship in Exodus 24," *Journal of the Evangelical Theological Society* 39:2 (June 1996):181.

"In the blood sprinkled on the altar [v. 6], the natural life of the people was given up to God, as a life that had passed through death, to be pervaded by His grace; and then through the sprinkling upon the people [v. 8] it was restored to them again, as a life renewed by the grace of God. In this way the blood not only became a bond of union between Jehovah and His people, but by the blood of the covenant, it became a vital power, holy and divine, uniting Israel and its God; and the sprinkling of the people with this blood was an actual renewal of life, a transposition of Israel into the kingdom of God, in which it was filled with the powers of God's spirit of grace, and sanctified into a kingdom of priests, a holy nation of Jehovah (19:6)."<sup>1</sup>

"The throwing of half of the blood of the offerings against the altar, which represented the Lord, and half on the people, or that which represented them, signifies a joining together of the two contracting parties (*communio*), and symbolized the execution of the deed of covenant between them. Between one blood-throwing and the other, the content of the covenant was finally and solemnly ratified by Moses' reading from the Book of the Covenant and by the people's expression of consent."<sup>2</sup>

This ritual—sprinkling half the blood on the altar and half on the people—constituted the formal ratification of the Mosaic Covenant, by which Yahweh adopted Israel as His "son" (cf. Gen. 15). The parallel with the inauguration of the New Covenant is striking (cf. Matt. 26:28; 1 Cor. 11:25).

"In all such ceremonies the oath of obedience [v. 7] implied the participants' willingness to suffer the fate of the sacrificed animals if the covenant

---

<sup>1</sup>Keil and Delitzsch, 2:158.

<sup>2</sup>Cassuto, p. 312. Paragraph division omitted.

stipulations were violated by those who took the oath."<sup>1</sup>

"Virtually every sovereign-vassal treaty incorporated a list of deities before whom the solemn oaths of mutual fidelity were sworn. These 'witnesses' could not, of course, be invoked in the case of the biblical covenants, for there were no gods but Yahweh and no higher powers to whom appeal could be made in the event of covenant violation. The counterpart of this is not lacking, however, for the ceremony of covenant-making described in Exodus 24 clearly includes 'witnesses' to the transaction. These are in the form of the altar, which represented Yahweh, and the twelve pillars, which represented the twelve tribes. Although there is no explicit word to the effect that these objects were witnesses as well as representations, the use of inanimate objects in that capacity elsewhere certainly allows for that possibility here."<sup>2</sup>

"This is the covenant meal, the peace offering, that they are eating there on the mountain. To eat from the sacrifice meant that they were at peace with God, in covenant with him. Likewise, in the new covenant believers draw near to God on the basis of sacrifice, and eat of the sacrifice because they are at peace with him, and in Christ they see the Godhead revealed."<sup>3</sup>

There is some disagreement among the commentators about the meaning of "the Book of the Covenant" (v. 7). Most take it to mean the "Bill of Rights" that God had just given (20:22—23:33).<sup>4</sup> Some feel it included "the whole corpus of Sinai

---

<sup>1</sup>Youngblood, p. 110.

<sup>2</sup>Merrill, "A Theology ...," pp. 34-35. Cf. Deut. 4:26; 30:19; 31:28. See also Kline, *The Treaty ...*, p. 15.

<sup>3</sup>*The NET2 Bible* note on 24:11.

<sup>4</sup>E.g., Wolf, p. 153.

laws."<sup>1</sup> Others hold that "... it denotes a short general document, a kind of testimony and memorial to the making of the covenant."<sup>2</sup> I prefer the view that it refers to the covenant stipulations God had made known to the Israelites at this time, including the Decalogue and the "Bill of Rights." This seems most consistent with other references to this "book" in the text.<sup>3</sup>

Some scholars believe that this was the day that Israel became a nation.<sup>4</sup> Most scholars hold the observance of the first Passover as its beginning.

24:9-11 The ratification ceremony concluded with a meal (. 11), not a picnic lunch, but a covenant meal.

"'They ate and drank' describes a covenant meal celebrating the sealing of the covenant described in vv. 3-8 [cf. Gen. 31:44-54]."<sup>5</sup>

We must understand the statement that the leaders of Israel "saw the God of Israel" (v. 10) in the light of other passages (33:20-23; Isa. 6:1; John 1:18). Probably they only saw a representation of God in human form (cf. Isa. 6:1; Rev. 4:2, 6). The "pavement of sapphire" under God's feet contributed to the vision of God as the supra-terrestrial sovereign (cf. Ezek. 1:22; Rev. 4:6; 12:2).

"... what Moses and his companions experience is a theophany of the Presence of God, not a vision of his person, and what they see, bowed before even that awesome reality, is what could be seen from a position of obeisant prostration, the surface on which his Presence offered itself. ... The reference in v 10 may therefore be a double one, calling up the deep dark blue of an endless

---

<sup>1</sup>Childs, p. 506. See also Johnson, p. 74.

<sup>2</sup>Cassuto, p. 312.

<sup>3</sup>See Kaiser, "Exodus," p. 449.

<sup>4</sup>E.g., L. Wood, *A Survey ...*, p. 145.

<sup>5</sup>Kaiser, "Exodus," p. 450.

sky and the building materials of legendary divine dwelling-places."<sup>1</sup>

God in mercy did not consume the sinners before Him (v. 12). Rather, He allowed them to eat in His presence, thus symbolizing the fact that He was taking on the responsibility for their safety and welfare (cf. Gen. 31:44-46).<sup>2</sup>

"We have argued that the awkward surface structure of the narrative [in chapters 19—24], which results in the non-linear temporal ordering of events, can be explained when one takes into account the sequence structure of the narrative, particularly the use of the literary device called resumptive repetition. As a result of this literary device we have demonstrated that the narrative contains two different perspectives of the theophany. First, there is the perspective of Yahweh which emphasizes the preparation and execution of the covenant as well as highlighting the holiness of God, which is a key to understanding the relationship that exists between Yahweh and His people. Second, there is the perspective of the people, which is elaborated upon in the two resumptive narratives in 20, 18-21 and 24, 1-8. The first resumptive narrative in 20, 18-21, which elaborates in detail the fear of the people, serves as a preface and introduction to the Decalogue and Covenant Code. In addition, it also acts as a causal link between the fear of the people and their sinful acts below the mountain in Exod 32. The second resumptive narrative in 24, 1-8 elaborates in detail the ratification of the covenant and also leads into the subsequent ascent of Moses to the mountain where he receives the rest of God's regulations."<sup>3</sup>

### C. DIRECTIONS REGARDING GOD'S DWELLING AMONG HIS PEOPLE 24:12—31:18

Having given directions clarifying Israel's rights and responsibilities in the Book of the Covenant (20:22-23:33), God now summoned Moses up the

---

<sup>1</sup>Durham, p. 344.

<sup>2</sup>See Livingston, p. 157.

<sup>3</sup>G. C. Chirichigno, "The Narrative Structure of Exod. 19-24," *Biblica* 68:4 (1987):478-79.



mountain again, to receive His directions regarding Israel's worship. The Book of the Covenant specified how the Israelites were to live with one another, but the tabernacle showed them how God wanted them to worship Him.<sup>1</sup> The giving of directions regarding the tabernacle logically follows the ratification of the Mosaic Covenant. Having made this covenant, God would now dwell among His people. Instructions concerning the tabernacle explain how a holy God could dwell among His sinful people.

"The establishment of a covenant relationship necessitated a means whereby the vassal party could regularly appear before the Great King to render his accountability. In normal historical relationships of this kind between mere men, some sort of intercession was frequently mandatory and, in any case, a strict protocol had to be adhered to.<sup>2</sup> How much more must this be required in the case of a sinful people such as Israel, who must, notwithstanding, communicate with and give account to an infinitely transcendent and holy God."<sup>3</sup>

Why did Moses record God's instructions for the tabernacle before the people sinned by making the golden calf? It was, after all, the golden calf incident that led to the giving of the priestly laws.

"... according to the logic of the narrative, it was Israel's fear that had created the need for a safe approach to God, that is, one in which the people as such were kept at a distance and a mediator was allowed to represent them. It was precisely for this reason that the tabernacle was given to Israel."<sup>4</sup>

### **1. The revelation of the directions 24:12-18**

Moses stayed in the heights of the mountain 40 days and 40 nights, while God gave him the stone tablets of the law and all the details concerning the tabernacle and its worship. Thus Moses was completely dependent on God. Now that Israel had entered into a blood covenant with God, God purposed to dwell among His people (cf. John 1:14). Correspondingly, God

---

<sup>1</sup>Cf. Davis, p. 192.

<sup>2</sup>For Hittite practice, see O. R. Gurney, *The Hittites*, pp. 74-75.

<sup>3</sup>Merrill, "A Theology ...," pp. 48-49.

<sup>4</sup>Sailhamer, *The Pentateuch ...*, p. 58.

now dwells among Christians by His Holy Spirit, since Jesus Christ has ratified the New Covenant by shedding His blood.

As in 19:12-25, only Moses went up into God's presence; the rest of the Israelites remained below. We find the same separation in the tabernacle and temple, where only authorized persons were permitted to approach God closely.

The spectacular vision of the glory of the LORD on the mountain, "like a consuming fire" (v. 17), should have given the Israelites greater respect for God's revelation than they demonstrated later (cf. 32:1-8). There were three symbols of God's glory: the cloud, the fire, and the voice.

The Hebrew word translated ""settled," in verse 16, (NASB, NRSV, HCSB, NIV, TNIV, or "abode" AV, or "stayed" CEV, or "rested" NKJV, NEB, or "resided" NET2, lit. "dwelt" ESV) is transliterated *shekinah* in English (cf. 25:8; 40:35). The Jews called the cloud that indicated the special presence of God the *shekinah* (lit. the dwelling or abiding glory, i.e., of God). This term does not appear in the Old Testament but in the Targums. The Targums are explanations of the Hebrew Scriptures, written later in the Aramaic language for the benefit of Jews who, because of the Babylonian Captivity, had not learned Hebrew.

## 2. Contributions for the construction of the sanctuary 25:1-9

"In contrast to Egypt and other countries where many temples existed, Israel was to have only one place of worship."<sup>1</sup>

The people gave freely to build the tabernacle. This shows that they valued the privilege of having an intimate relationship with God. However, the Israelites found it easier to give to the construction of the tabernacle than to obey God faithfully. The same is true today. But God desires obedience more than sacrifice (1 Sam. 15:22-23).

---

<sup>1</sup>L. Wood, *A Survey ...*, p. 150.

"Only voluntary gifts were acceptable as materials for the Lord's house (25:2; 35:3, 21-22, 29), since love rather than compulsion is the basis of all truly biblical giving (2 Cor. 9:7)."<sup>1</sup>

"We should ask, not only, 'What must we do?' but, 'What may we do for God?'"<sup>2</sup>

Moses usually employed one of four different terms to describe the tabernacle, each of which emphasizes one of its purposes, though other names also appear:

1. Sanctuary (25:8) means "place of holiness," and stresses the transcendence of Israel's God as an Exalted Being who is different from His people. One of the purposes of this structure was to manifest the glory of God.<sup>3</sup> However, verse 8 also states that such a God would "dwell among" His people.<sup>4</sup>
2. Tabernacle (25:9) means "dwelling place," and emphasizes God's purpose of abiding near His people. The tabernacle looked like the other nomads' tents that the Israelites lived in. They would have thought of it as God's tent among their tents. It had furniture, just like their tents did.

"Just as they lived in tents, so God would condescend to 'dwell' in a tent."<sup>5</sup>

3. Tent of Meeting (27:21) also stresses the immanence of God. God "met" with Moses and the Israelites in this tent. The verb translated "meeting" means a deliberate prearranged rendezvous, rather than a casual accidental meeting. Some scholars believe that the tent of meeting was a different structure than the tabernacle, and that it was always outside the camp of Israel (cf. 33:7).<sup>6</sup> However, several references to it equate it with the tabernacle (e.g., 27:21; 29:30, 42; 30:18, 20; 30:36; 31:7; 38:30; 39:32, 40; 40:2, 6, 7, 22, 24,

---

<sup>1</sup>Youngblood, p. 113.

<sup>2</sup>Henry, p. 100.

<sup>3</sup>J. N. Darby, *Synopsis of the Books of the Bible*, 1:107.

<sup>4</sup>See Angel Manuel Rodriguez, "Sanctuary Theology in the Book of Exodus," *Andrews University Seminary Studies* 24:2 (Summer 1986):127-45.

<sup>5</sup>Youngblood, p. 114.

<sup>6</sup>E.g., Eugene H. Merrill, *Deuteronomy*, p. 401.

26, 29, 30, 34, 35). Apparently there was another tent, also called "the tent of meeting," where God met with Moses, that was different from the tabernacle (33:7-11).

4. Tabernacle of the testimony (38:21; Num. 9:15; 17:7, 8) indicates that the structure was the repository of the Law wherein God testified concerning His will. Moses sometimes referred to the ark of the covenant as the "ark of the testimony" (25:22), because it contained the two tablets of the testimony (31:18), on which were inscribed the Ten Commandments. The Ten Commandments are the "testimony." They were the essential stipulations of the Mosaic Covenant, the heart of the relationship between God and His people.

God specifically designed the tabernacle structure, and all its furnishings, to teach the Israelites about Himself—and how they as sinners could have a relationship with Him. It is interesting that in the chapters to follow we have few explanations of specifically what the plan, pieces, and purposes signified. Later revelation helps us understand this partially, but interpreters of this material have had to do a lot of guessing.

"The thoughts of God concerning salvation and His kingdom, which the earthly building was to embody and display, were visibly set forth in the pattern shown [to Moses]."<sup>1</sup>

"The tabernacle also provided a prophetic prefigurement of the redemptive program of God as focused in Jesus Christ. ... [It] was a remarkable picture of the high priestly work of Christ both here on earth and His eternal work in the heavens."<sup>2</sup>

"Probably the conception of the *tabhnith*, the 'model' (Exodus 25:9), also goes back ultimately to the idea that the earthly sanctuary is the counterpart of the heavenly dwelling of a deity."<sup>3</sup>

---

<sup>1</sup>Keil and Delitzsch, 2:167.

<sup>2</sup>Davis, pp. 245-56.

<sup>3</sup>Frank M. Cross Jr., "The Tabernacle," *Biblical Archaeologist* 10:3 (September 1947):62. For a good introduction to the background of the tabernacle, see G. Ernest Wright, "The Significance of the Temple in the Ancient Near East," *Biblical Archaeologist* 7:4 (December 1944):65-77. Cf. Exod. 25:40; Heb. 8:5.

"Commentators for centuries have noticed that the phrase 'the LORD said to Moses' occurs seven times in chapters 25—31. The first six concern the building of the tabernacle and its furnishings (25:1; 30:11, 17, 22, 34: 31:1), while the final introduces the Sabbath command (31:12). It seems clear that the purpose of this arrangement is to aid the reader in making the connection between the building of the tabernacle and the seven days of creation, both of which involve six creative acts culminating in a seventh-day rest."<sup>1</sup>

Is there a literal tabernacle in heaven? Verses like Hebrews 8:5, and 9:23 and 24, have led some interpreters to answer: Yes.<sup>2</sup> Most believe that heaven itself is this tabernacle.

"... the tabernacle is an earthly representation of a heavenly reality—a portable Mount Horeb/Sinai."<sup>3</sup>

### **3. The tabernacle furnishings 25:10-40**

One writer identified three major problems the interpreter faces as he or she seeks to understand God's revelation concerning the tabernacle:<sup>4</sup>

1. What was the length of the cubit, the standard measure of length? This is a problem, because the various ancient nations had different lengths for their cubits. A cubit was usually the distance between a person's elbow and middle fingertip. The length ranged from about 17 inches to 21 inches, but there is good reason to believe that the Hebrew cubit at that time was 17.5 inches, or about one and a half feet.
2. What about the information omitted in the text? Anyone who has tried to make a model or detailed drawing of the tabernacle and its furnishings has experienced frustration, because the data given in the text is incomplete. Undoubtedly God revealed all the details to Moses (cf. 25:40; 26:30). However, He has preserved in Scripture

---

<sup>1</sup>Enns, p. 509. See also pp. 507, 521, 550.

<sup>2</sup>E.g., McGee, 1:279.

<sup>3</sup>Enns, p. 532.

<sup>4</sup>Davis, pp. 246-51.

only those details necessary for our understanding of the functioning and fundamental significance of the tabernacle.

3. What was the exact shape of the tabernacle? The text does not enable us to know for certain if it had a flat roof or a gabled roof formed by a ridgepole. Both possibilities have problems connected with them, but the flat roof design seems more probable, all things considered. A gabled roof would have increased the measurement of the roof beyond the specified width of 15 feet, so that the curtains over the roof and sides would not have fully covered the sides.

Another problem is the extent of typological teaching that God intended. A type (Gr. *typos*, cf. *antitypos*) is a divinely intended illustration.<sup>1</sup> Thus all types are illustrations, but not all illustrations are types.<sup>2</sup> How much detail did God intend to illustrate His character and relationship with His people? Some commentators have seen more types and others less.

We know that the major aspects of the tabernacle and its furnishings are types, because the New Testament writers identified them as such (Heb. 3:4-5; 8:5; 9:8-9, 23-24; 10:20). However, the amount of detail Moses preserved, and the obvious significance of certain details not identified as types, have led many commentators to conclude that God intended these details to be instructive, too. Some commentators have taken this teaching to extend even to the numbers and colors used that, in some cases in Scriptural usage, do have symbolic significance.<sup>3</sup>

"Everything in the tabernacle speaks of either the person or work of Christ. Every covering, every thread, and every article of furniture reveals some facet of the Savior."<sup>4</sup>

---

<sup>1</sup>Charles C. Ryrie, *The Holy Spirit*, p. 23.

<sup>2</sup>See Terry, pp. 334-46; Baxter, 1:53-62; Paul L. Tan, *The Interpretation of Prophecy*, pp. 166-74; Roy B. Zuck, *Basic Bible Interpretation*, pp. 169-84.

<sup>3</sup>Examples of extensive typological interpretation are Edward Dennett, *Typical Teachings of Genesis*; C. H. M[ackintosh], *Notes on the Pentateuch*, vols. 3-5; A. J. Pollock, *The Tabernacle's Typical Teaching*; Samuel Ridout, *Lectures on the Tabernacle*; H. W. Soltau, *The Tabernacle, the Priesthood and the Offerings*. See Gerald R. McDermott, "Typology in Creation," *Bibliotheca Sacra* 175:697 (January-March 2018):5-16, for an argument for extensive typology.

<sup>4</sup>McGee, 1:285. See also idem, *The Tabernacle: God's Portrait of Christ*.

"There are more types of Christ in this book than perhaps in any other book of the Old Testament; for Moses wrote of him, John v. 46."<sup>1</sup>

Some commentators have taken this too far, in the judgment of other students of Exodus.

I prefer a cautious approach myself. It is obvious that there are many illustrations of New Testament truth in the Old Testament. This seems clear in view of the amount of detail God preserved in these chapters describing the tabernacle, as well as direct statements to that effect in the New Testament (e.g., Luke 24:27; John 5:46; 1 Cor. 10:6-11; et al.). It also seems clear, since the illustrative significance of some features of the tabernacle is so obvious, even though the New Testament does not identify them as types.

An extremely conservative approach would be to identify as types only those things that the New Testament calls types.<sup>2</sup> These would include Adam (Rom. 5:14), the wilderness wanderings of Israel (1 Cor. 10:6, 11), the holy place in the tabernacle and temple (Heb. 9:24), and the flood in Noah's day (1 Pet. 3:21). Some conservative interpreters refer to other foreshadowings simply as illustrations.<sup>3</sup>

Josephus, following Philo, interpreted the tabernacle, its furniture, and the priests' garments symbolically. He wrote that the seven branches of the lampstand represent the courses of the planets. The colors of the curtains and clothing represent the four elements (earth, water, air, and fire). The two shoulder stones stand for the sun and moon. The 12 breastplate stones represent the 12 months or the 12 signs of the Greek zodiac.<sup>4</sup> Josephus' suggestions, however, do not seem to be the best interpretations of the significance of these things.

Note that the order in which Moses described the things associated with the tabernacle in the text, is not what one would normally expect. For example, we would expect that after the description of the altar of burnt offerings, we would have a description of the laver. The altar of burnt offerings was the major piece of furniture in the courtyard, and the first

---

<sup>1</sup>Henry, p. 72.

<sup>2</sup>See J. Barton Payne, *The Theology of the Older Testament*, p. 357.

<sup>3</sup>See Paul Lee Tan, *Principles of Literal Interpretation of the Bible*, pp. 36-39.

<sup>4</sup>Josephus, *Antiquities of ...*, 3:7:7.

one the Israelite would meet as he entered the courtyard. Then the laver was the second most prominent item, because it would catch the Israelite's eye next. It was also the object between the altar and the tabernacle. However, instead, we read about the altar of burnt offerings, then the priestly vestments, then the consecration of Aaron, and then, finally, the laver.

This order is due, I believe, to two major emphases in the revelation: First, Moses was describing things that primarily manifest God, and second, things dealing with His people's fellowship with God. So the author was first describing things in the most holy place (or holy of holies), where God dwelt, then things in the holy place, and then finally things in the courtyard. This order, therefore, focuses attention on the presence of Yahweh among His people, which was the most important feature of Israel's life. The tabernacle itself also reflects the importance of Yahweh's presence, since it was at the center of the Israelites' camp.

"Perhaps we might take another view of the general arrangement of these courts. May we not say that there is something here to remind us of each person of the Godhead? In yonder *Holy of holies*, behind the veil, in light inaccessible, is the symbol of *the Father*. Then, at yonder gate, meeting the view of every inquirer, is the Altar of Sacrifice, the symbol of *the Son*, who said, 'Lo, I come.' And between stands the laver of pure water, the symbol of the *Holy Ghost*. The whole might be called Ephesians ii. 18 written in sacred hieroglyphics—*'Through Him we both have access by one Spirit unto the Father.'*"<sup>1</sup>

"The tabernacle was built on a ratio of 2:1 and on a radiating decrease value of metal: gold, silver, bronze, from the center [where God dwelt] to the outer edges."<sup>2</sup>

The metals, woods, and fabrics that the Israelites were to use in the construction of the tabernacle and its worship, were the finest and rarest available. This reflected the fact that nothing but the best was appropriate for the worshippers' response to Yahweh. What was at the center of

---

<sup>1</sup>Andrew A. Bonar, *A Commentary on Leviticus*, p. 151.

<sup>2</sup>Livingston, p. 178.



priestly concern, was not a building or a ritual—but the LORD Himself, being present as a gift to His people.<sup>1</sup>

### The ark of the covenant 25:10-22

The ark was the "throne" of Yahweh on earth, where He dwelt in a localized way, and met with the Israelites through their high priest. It was the "seat" of His sovereignty, but also the place where He met with His people (v. 22). This is why directions for its construction come first.

"In determining *the significance of the Ark* the overwhelmingly probable assumption from which to start is that it represents the 'unoccupied throne of the deity', a class of sacred objects of which instances are to be found outside Israel."<sup>2</sup>

The "testimony" (two tablets inscribed with the Ten Commandments, vv. 16, 22) lay inside the ark, which was a hollow box. God's dwelling among His people, and His relationship with them, thus, quite literally, rested on the Ten Commandments. The "atonement cover" (v. 17, or "atonement cover" NIV, TNIV, or "mercy seat" AV, NKJV, HCSB, NRSV, ESV) was the removable lid of this box, and was pure gold. It was on this lid that the high priest offered sacrificial blood once a year, sprinkling the blood to atone for the sins of the Israelites as a nation. This offering made propitiation (satisfaction) for their sins for one year (cf. Lev. 16).

The Greek word here in the Septuagint, used to translate "atonement cover" (*hilasterion*), is another form of the word used to describe Jesus Christ as Christians' propitiation (*hilasmos*) in 1 John 2:2. The "mercy seat" was for the Israelites, temporarily, what Jesus Christ is for all people, permanently: the place where God found satisfaction.

"It [mercy] is a sweet word! A seat of mercy, baptised [*sic*] in mercy, from which mercy flows forth. Not wrath, not judgment, not indignation, but mercy is pouring forth from its original fountain in the heart of God."<sup>3</sup>

The cherubim (v. 18) were special angels, and the gold cherubim on the mercy seat represented real angels—in God's presence—who "apparently

---

<sup>1</sup>Durham, p. 355.

<sup>2</sup>Eichrodt, 1:107-8.

<sup>3</sup>Meyer, p. 307.

have to do with the holiness of God as violated by sin."<sup>1</sup> They may have looked like winged human-headed lions.<sup>2</sup> Josephus wrote that Moses saw these creatures around God's throne when he was on Mt. Sinai.<sup>3</sup>

---

<sup>1</sup> *Unger's Bible Dictionary*, s.v. "Cherub," by Merrill F. Unger, pp. 191-92.

<sup>2</sup> Youngblood, p. 122; cf. Kaiser, "Exodus," p. 455.

<sup>3</sup> Josephus, *Antiquities of ...*, 3:6:5. See John T. Bunn, "The Ark of the Covenant," *Biblical Illustrator* 9:4 (Summer 1983):50-53. Geoffrey Kind, "Where Is the Ark of the Covenant?" *Prophetic Witness* 8:2 (February 1984):9-10, suggested several possible answers to the title question. See also A. H. Tolhurst, "Whatever Happened to the Ark?" *Ministry* (June 1984), pp. 13-15.

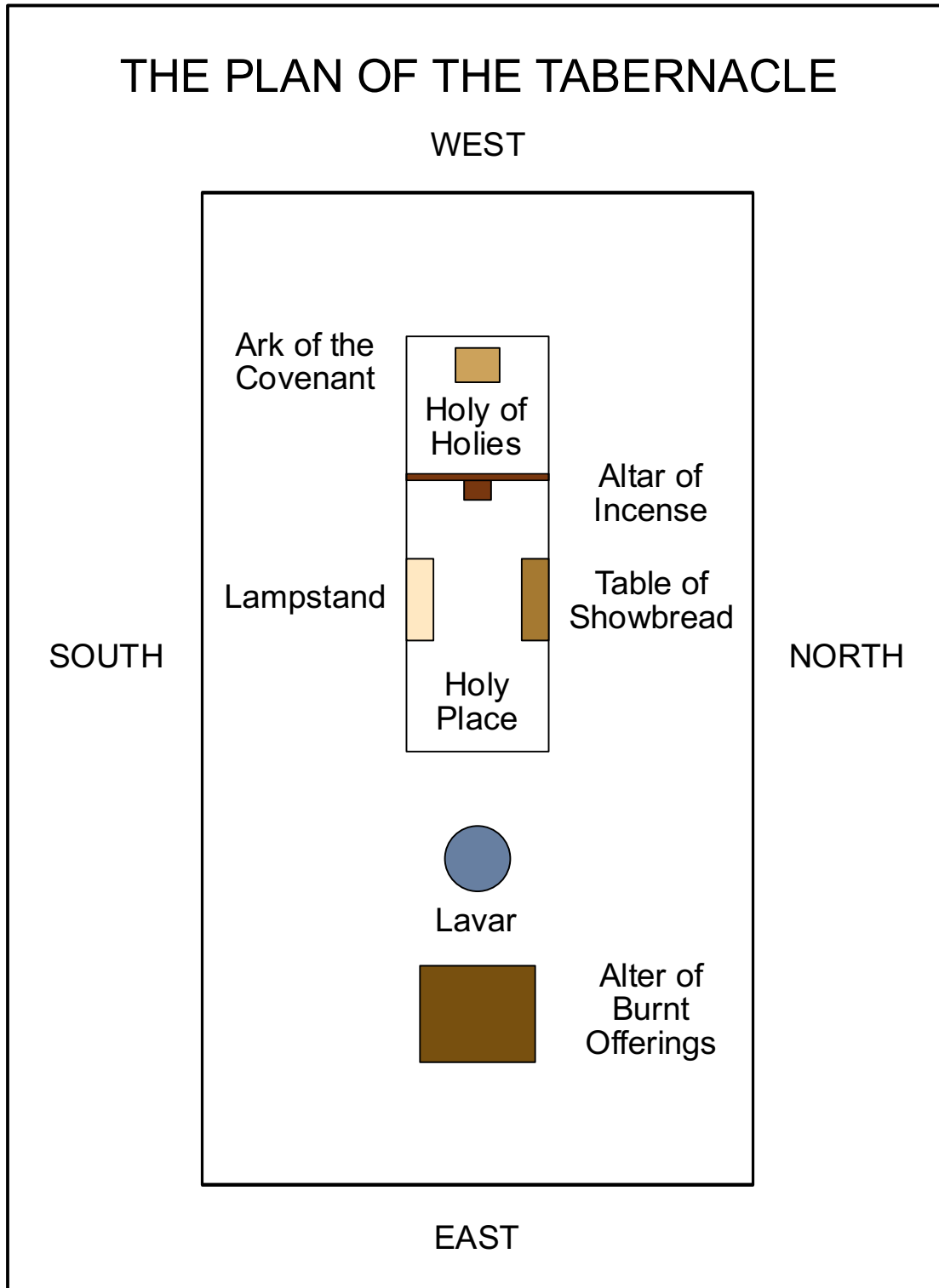

"The cherubim are connected with the throne as its guardians and/or bearers [e.g., 1 Sam. 4:4; 2 Sam. 6:2; Ps. 80:1; 99:1]. In other cultures cherubim are minor deities protective of

palaces and temple; in Israel they symbolized angelic guardians of the invisible throne of God."<sup>1</sup>

"As with the tabernacle in general, the ark also has ancient Near Eastern parallels. In King Tut's tomb, for example, was found a cedar chest complete with rings and poles. Depositing the law inside a sacred place (cf. 25:16, 21) is also known from other ancient sources. The same is true of the cherubim that sit atop the cover of the ark. These were common symbols in the ancient world, and the Israelites were no doubt familiar with them."<sup>2</sup>

This familiarity probably explains in part why we do not have more detail given in Exodus: The Israelites who first received this revelation knew some things that we do not know today and could fill in the gaps in the LORD's instructions.

Some have seen the composition of the ark as illustrative of the person of Christ: wood (His humanity) overlaid with gold (His deity). The mercy seat was pure gold, suggesting the perfection of Christ's work of atonement.<sup>3</sup>

### **The table of showbread 25:23-30**

This piece of furniture stood on the north side of the holy place, the right side as the priest entered from the courtyard. The priests placed twelve loaves (or large pieces) of unleavened<sup>4</sup> bread, called "the bread of the Presence," in two rows<sup>5</sup> or piles<sup>6</sup> on this table, where they remained for seven days. Evidently the flat bread was stacked in two piles, like pancakes. The priests substituted twelve fresh loaves for the old bread each Sabbath (Lev. 24:5-8). The term "bread of the Presence" (v. 30) means that these

---

<sup>1</sup>Waltke, *An Old ...*, p. 460.

<sup>2</sup>Enns, pp. 511-12.

<sup>3</sup>McGee, *Thru the ...*, 1:280-81.

<sup>4</sup>Josephus, *Antiquities of ...*, 3:6:5.

<sup>5</sup>Henry, p. 100; William L. Lane, *Hebrews 9—13*, p. 220.

<sup>6</sup>Josephus, *Antiquities of ...*, 3:6:6; Jamieson, et al., p. 74; Edersheim, p. 185; Bill Mitchell, "Leviticus 24:6: The bread of the presence—rows or piles?" *The Bible Translator* 33:4 (October 1982):447-48.

loaves lay before God's presence in the tabernacle.<sup>1</sup> The Israelites did not offer this food for Yahweh to eat, as the pagans offered food to their gods.<sup>2</sup>

They did so "as a symbol of the spiritual food which Israel was to prepare (John 6:27; cf. 4:32, 34), a figurative representation of the calling it had received from God."<sup>3</sup>

"Ancient symbolism, both Jewish and Christian, regarded 'the bread of the Presence' as an emblem of the Messiah."<sup>4</sup>

"The twelve loaves constituted a perpetual thank offering to God from the twelve tribes for the blessings that they received from Him day by day."<sup>5</sup>

"By its opulence as by the containers and the food and drink placed continuously upon it and periodically renewed, this Table announces: 'He is here,' and here as one who gives sustenance."<sup>6</sup>

"The bread and the wine, situated as they are just outside the Most Holy Place, are a continual reminder of the covenant that the holy God, who is located behind the curtain just several feet away, has made with his people."<sup>7</sup>

Perhaps the bread signified both God's provisions and Israel's vocation, since Israel was to be a source of spiritual food for the world (19:5-6).

"... the table and the bread of the Presence have been taken as a type of the church which stands in Christ's (the ark) presence."<sup>8</sup>

---

<sup>1</sup>See Edersheim, p. 182, for discussion of the origin of the old word "shewbread."

<sup>2</sup>Kaiser, "Exodus," p. 456.

<sup>3</sup>Keil and Delitzsch, 2:171.

<sup>4</sup>Edersheim, p. 186. Cf. McGee, *Thru the ...*, 1:282.

<sup>5</sup>Davis, p. 255.

<sup>6</sup>Durham, p. 362.

<sup>7</sup>Enns, p. 514.

<sup>8</sup>Sailhamer, *The Pentateuch ...*, p. 302.

### The lampstand 25:31-40

This piece of furniture was probably similar in size to the table of showbread. It stood opposite that table in the holy place, against the south (left) wall (26:35). It weighed about 75 pounds ("a talent of pure gold," v.39). The tabernacle craftsmen fashioned it in the form of a stylized plant or tree, probably an almond tree. It connoted life and fertility.

"The signification of the seven-armed candlestick is apparent from its purpose, viz. to carry seven lamps, which were trimmed and filled with oil every morning, and lighted every evening, and were to burn throughout the night (chap. xxvii. 20, 21, xxx. 7, 8; Lev. xxiv. 3, 4). As the Israelites were to prepare spiritual food in the shew-bread in the presence of Jehovah, and to offer continually the fruit of their labour in the field of the kingdom of God, as a spiritual offering to the Lord; so also were they to present themselves continually to Jehovah in the burning lamps, as the vehicles and media of light, as a nation letting its light shine in the darkness of this world (cf. Matt. v. 14, 16; Luke xii. 35; Phil. ii. 15). The oil, through which the lamps burned and shone, was, according to its peculiar virtue in imparting strength to the body and restoring vital power, a representation of the Godlike spirit, the source of all the vital power of man; whilst the oil, as offered by the congregation of Israel, and devoted to sacred purposes according to the command of God, is throughout the Scriptures a symbol of the Spirit of God, by which the congregation of God was filled with higher light and life. By the power of this Spirit, Israel, in covenant with the Lord, was to let its light shine, the light of its knowledge of God and spiritual illumination, before all the nations of the earth. In its *seven* arms the stamp of the covenant relationship was impressed upon the candlestick; and the almond-blossom with which it was ornamented represented the seasonable offering of the flowers and fruits of the Spirit, the almond-tree deriving its name ... from the fact that it is the earliest of all the trees in both its blossom and its fruit (cf. Jer. 1:11, 12). The symbolic character of the candlestick is clearly indicated in the Scriptures. The prophet Zechariah (chap. 4) sees a golden candlestick with seven lamps and two olive-trees, one on either

side, from which the oil-vessel is supplied; and the angel who is talking with him informs him that the olive-trees are the two sons of oil, that is to say, the representatives of the kingdom and priesthood, the divinely appointed organs through which the Spirit of God was communicated to the covenant nation. And in Rev. 1:20, the seven churches, which represent the new people of God, i.e., the Christian Church, are shown to the holy seer in the form of seven candlesticks standing before the throne of God."<sup>1</sup>

"In company with the Table attesting Yahweh's Presence in bounty and the Ark attesting Yahweh's Presence in mercy and revelation, the Lampstand symbolized Yahweh's Presence in perpetual wakefulness, through the reminder of the almond tree and the continual brightness of the living fire (cf. Num 17:16-26 [17:1-11]). The watcher over Israel never nodded, much less slept (Ps 121:4)."<sup>2</sup>

Like the showbread, the burning lamps may have symbolized both the character of God and the calling of Israel. The seven-branched lampstand (*menorah*) has been, and still is, a popular symbol of Judaism and Israel around the world. A bas relief of the lampstand that stood in Herod's Temple is still visible on an inside panel of the Arch of Titus that stands today in Rome. The Romans built this arch following Titus' destruction of Jerusalem in A.D. 70.

"The lampstand is commonly taken to be a type of Christ, usually on the basis of Revelation 1:4 [cf. vv. 12-13]. It has also been taken as a symbolic image of the Law."<sup>3</sup>

#### **4. The tabernacle structure ch. 26**

The tabernacle walls consisted of rigid supports—a framework of boards or frames supported and held together by sockets, bars, tenons, and rings—with curtains hung over the entire framework. These draperies, that made up the tabernacle's tent-coverings, on its sides, also evidently formed its ceiling. Most commentators believe that the tabernacle was a single unified

---

<sup>1</sup>Keil and Delitzsch, 2:174-75.

<sup>2</sup>Durham, p. 365.

<sup>3</sup>Sailhamer, *The Pentateuch ...*, p. 302.

structure, but a few believe it consisted of three separate structures, one on top of the other. These three structures were: the tabernacle proper (the supporting framework of boards and connecting sockets, rings, bars, and tenons), a first tent over it made of goat hair, and a second tent of skins that covered both of these structures.<sup>1</sup>

The tabernacle as a whole illustrates four different things, according to Scripture. It represents the heavens where God dwells, from which He manifests Himself (Heb. 4:14; 9:23-24), the work of Christ (John 2:19-21; Heb. 3:3-4; 8:2; 9:11-12), the individual believer (1 Cor. 6:19), and the church (1 Tim. 3:15; Heb. 3:6; 10:21).

"The tabernacle seems to represent a microcosm of creation itself. The splendor and beauty of the materials used—fine fabrics, precious metals, and stones—affirm the goodness of the created world. The precise and perfect dimensions of the tabernacle indicate a sense of order amid chaos. ...

"in the midst of a fallen world, in exile from the Garden of Eden—the original 'heaven on earth'—God undertakes another act of creation, a building project that is nothing less than a return to pre-Fall splendor. ... If this is a correct understanding of the tabernacle, we begin to see why the writer of Exodus devotes so much space to its description."<sup>2</sup>

### The curtains 26:1-14

The extent to which these curtains were visible from inside the tabernacle is not clear in the text, and has been the subject of debate by commentators. They were of four colors that some writers have interpreted as having symbolic significance, on the basis of other biblical references to and uses of these colors. The colors were white (holiness), blue (heavenly origin and character), purple (royal glory), and crimson (blood and vigorous life).<sup>3</sup> Blue was also the color of garments that certain people of high social standing wore (e.g., the high priest, 28:31; people of royalty or nobility, 1 Sam. 18:4; 24:4).

---

<sup>1</sup>Ibid., pp. 302-3.

<sup>2</sup>Enns, pp. 521-22.

<sup>3</sup>E.g., McGee, *Thru the ...*, 1:285.



"Woven into the fabric of the curtains were images of cherubim, apparently intended to recall the theme of 'paradise lost' by alluding to the cherubim which guarded the 'Tree of Life' in Genesis 3:24."<sup>1</sup>

Another view is that the cherubim were to remind the Israelites that angels surrounded them.<sup>2</sup>

Likewise the clasps that joined the separate curtains together (v. 6) may have been intended to remind them that, though they were many (individual tribes, clans, and families), they were joined together as one nation and people of God (cf. Eph. 2:21-22; 4:16).<sup>3</sup>

Some interpreters have seen the goats' skins as signifying separation from evil. The later prophets in Israel, who dressed in goatskins, called the people to holiness and separation from evil. Incidentally, it was the "scapegoat" who carried away the sins of the nation, separating the sins from the people in "its own skin," into the wilderness. Some have felt that the rams skins dyed red taught the Israelites the importance of devotion to God, since He specified the use of rams in some offerings of worship. A slightly different interpretation follows:

"Within the sanctuary, moving from the inside out, the curtains of fine linen were visible only to the priests who served in the presence of him who is purity and righteousness itself. The curtains of goats' hair were reminders of the daily sin offering that was a kid from the goats (Num 28:15) and of our cleansing from sin (Lev 16). The covering of rams' skins also recalled the sacrifice used in consecrating the priesthood (Lev. 8); and it was deliberately dyed red, showing that the priesthood was set apart by blood. Finally, the protective coating of the sea cows' hides [NIV, or "manatee skins" HCSB, or "badger skins" AV, NKJV, or "goatskins" ESV, or "fine leather" NASB, NRSV, NET2, or "durable leather" TNIV] marked a protective separation between the dwelling place of God and the world."<sup>4</sup>

---

<sup>1</sup>Sailhamer, *The Pentateuch ...*, p. 303.

<sup>2</sup>Henry, p. 101.

<sup>3</sup>Ibid.

<sup>4</sup>Kaiser, "Exodus," p. 459.

J. Vernon McGee saw different meanings in these curtains:

"This [first embroidered linen] covering could not be seen from the outside at all and, frankly, the beauty of the Lord Jesus Christ can not be seen by the world. ... The second curtain was made of goats' hair and it touched the ground. This curtain speaks of Christ's worth for sinners. It is symbolic of the death of Christ, and this is the message that is to be given to the world. ... The third covering was made of rams' skin dyed red. This curtain speaks of the strength and vigor of Christ and His offering on the cross. This curtain shows the outward aspect of His offering as our substitute. ... The fourth curtain was made of badgers' skins (sealskins). ... This covering speaks of Christ's walk before men."<sup>1</sup>

The total area covered by these tapestries was 45 feet long by 15 feet wide by 15 feet high. The most holy place was a 15-foot cube, and the holy place was 30 by 15 by 15 feet. Thus, the tabernacle structure was only about one and a half modern parking spaces wide, and a little more than two parking spaces long.

### The boards 26:15-25

It is not clear whether these boards were solid planks (HCSB, NEB) or frames (NIV, TNIV, ESV, NRSV, NET2, CEV). The meaning of the Hebrew word (*garesh*, "boards") is uncertain. The latter view might be more probable.<sup>2</sup> However, Josephus wrote that "the joints [of the boards] were invisible, and both [boards on either side of these joints] seemed to be one entire and united wall."<sup>3</sup> If they were solid, the priests would not have been able to see, from within, the colorful curtains hanging down over the outside of the tabernacle. If these boards were frames, though, they could have seen them, or at least the most interior covering, through the walls. The embroidered curtains at least seem to have been visible overhead, in either case, and likely reminded the priests of God's celestial throne.

---

<sup>1</sup>McGee, *Thru the ...*, 1:285. Paragraph divisions omitted.

<sup>2</sup>Durham, p. 372.

<sup>3</sup>Josephus, *Antiquities of ...*, 3:6:3.

### The bars 26:26-30

These bars were evidently rods that the priests threaded through the boards—actually through the rings attached to the boards—horizontally, in order to give the boards stability, like a solid wall, and to hold them upright. These bars or rods may have had significance to the Israelites, which some commentators have speculated upon, or they may have simply served the practical purpose of strengthening the tabernacle walls.

### The veil 26:31-35

The veil and curtains were alike in design and construction, both woven with three colored fabrics: blue, purple, and scarlet. Arthur Pink wrote some interesting comments about these colors:

"This order 'blue, purple and scarlet' is repeated over twenty times in Exodus, and is never varied. ... The 'blue' is the color of heaven, and speaks of Christ as the Son of God. The 'scarlet' is both the color of sacrifice and human glory. The 'purple' is a color produced by the mixing together of blue and scarlet. Without the purple, the blue and the scarlet would have presented too vivid a contrast to the eye; the purple coming in between them shaded off the one extreme from the other.

"Now the antitype of these colors is found in the incarnate Christ. He was both God and man, and yet these two vastly dissimilar natures unite in one perfect Person. The 'purple,' then, coming in between the 'blue' and the 'scarlet' tells of the perfect blending or union of His two natures."<sup>1</sup>

The veil was hung in order to serve as an interior wall, separating the holy and most holy places into two rooms. Some extrabiblical references to a second veil, between the holy and most holy places, have created confusion.<sup>2</sup> The Old Testament is clear that there was just one. The Book of Hebrews used the veil in the temple, which replaced this one in the tabernacle, as a symbol of Jesus Christ's body. Literally torn in His crucifixion, both Christ and, symbolically, the temple veil, opened the way

---

<sup>1</sup>Arthur W. Pink, *Exposition of the Gospel of John*, 2:192.

<sup>2</sup>See Henry van der Meulen, "One or two veils in front of the holy of holies?" *Theologia Evangelica* 18:1 (March 1985):22-27.

for access into God's presence (Heb. 10:20; cf. Matt. 27:50-51; Mark 15:37-38; Luke 23:45-46).

"The veil was hung upon four pillars and speaks of the humanity of Jesus Christ. The pillars were made of shittim [AV, or acacia NASB, NKJV, NIV, TNIV, NRSV, ESV, HCSB, NET2] wood covered with gold, with silver sockets attached. These speak of deity taking hold of earth through redemption."<sup>1</sup>

"'Acacia wood' ... is a species of the mimosa (*Mimosa Nilotica*), whose wood is darker and harder than oak and therefore not subject to wood-eating insects. It is common in the Sinai Peninsula."<sup>2</sup>

"Some students see a parallel between the four Gospels and the four pillars that supported the veil with the four colors. Purple speaks of royalty—the Gospel of Matthew, the Gospel of the King. Scarlet reminds us of sacrifice—the Gospel of Mark, the Gospel of the Suffering Servant. White speaks of the perfect Son of Man—the Gospel of Luke, and blue points to heaven—the Gospel of John, the Gospel of the Son of God who came from heaven to die for our sins."<sup>3</sup>

### The screen 26:36-37

The screen was a drapery—woven, like the veil and curtains, from blue, purple, and scarlet fabrics. It served as the front door-flap to the tabernacle.

"The techniques used for the Tabernacle—gilded frames and beams, with coverings—were those used for 'prefab' structures (religious and otherwise) in Egypt for up to fifteen centuries before Moses."<sup>4</sup>

---

<sup>1</sup>McGee, *Thru the ...*, 1:286.

<sup>2</sup>Kaiser, "Exodus," revised ed., p. 511.

<sup>3</sup>Wiersbe, p. 238.

<sup>4</sup>Kitchen, *The Bible...*, pp. 85-86. See also J. E. Jennings, "Ancient Near Eastern Religion and Biblical Interpretation," in *Interpreting the Word of God*, pp.23-26.

## **5. The tabernacle courtyard 27:1-19**

In this section, Moses described the altar of burnt offerings, the courtyard itself, and the oil for the lamps on the lampstand, that the priests evidently prepared in the courtyard.

"As you get closer to God, the emphasis is on the person of Christ. As you move farther out, the emphasis is on the work of Christ."<sup>1</sup>

### **The altar of burnt offerings 27:1-8**

The height of this altar was about four and a half feet (3 cubits). This height has led some commentators to suggest that a step-like bench or ledge may have surrounded it, on which the priests stood when they offered sacrifices.<sup>2</sup> In view of the command prohibiting steps up to Israel's altars (20:26), a ramp seems possible (cf. Lev. 9:22). However, there may have been neither a ramp nor steps. Another possibility is that the earlier prohibition of steps was now changed allowing for them.<sup>3</sup>

The altar had four "horns" (v. 2), one on each corner, to which the priests applied blood ritually (29:12). These protrusions were shaped like animal horns, hence the name. People occasionally clung to this altar, holding onto the horns, as a place of refuge (cf. 1 Kings 1:50-51; 2:28). The priests also bound some animals to these horns when they sacrificed them (Ps. 118:27). There was a grate ("a netting of bronze," v. 4) halfway to the ground, inside the altar, that allowed air to circulate under the sacrifices, and ashes to fall to the ground below. The "ledge" (or "compass" AV, or "rim" NKJV), was perhaps a projection on the inside of the altar, halfway up its sides, on which the bronze grate rested.

This bronze altar received, on God's behalf, the offerings of the Israelites.

"We present to Him our bodies (Rom. 12:1-2), or material wealth (Phil. 4:18), praise and good works (Heb. 13:15-16), and a broken heart (Ps. 51:17)."<sup>4</sup>

---

<sup>1</sup>McGee, *Thru the ...*, 1:286.

<sup>2</sup>E.g., Keil and Delitzsch, 2:186-87.

<sup>3</sup>Kaiser, "Exodus," revised ed., p. 487.

<sup>4</sup>Wiersbe, p. 237.

God met the Israelite where he was, in the courtyard, rather than where He was, within the veil. Nevertheless, the Israelite had to make a special effort to approach God, by entering the courtyard to present his offering (cf. 2 Cor. 5:18-20). There was only one entrance (cf. John 10:9; 14:6).

"The position of the Altar just inside the entrance to the court made it as clear as symbology could that the beginning of fellowship between God and man must be in sacrifice."<sup>1</sup>

"It [this altar] speaks of the cross of Christ, and of the fact that He is actually the One who died in man's stead. ... The cross was God's chosen altar of sacrifice."<sup>2</sup>

The Book of Hebrews viewed this altar as a prototype of the better "Altar," which is Jesus Christ (Heb. 13:10).

### **The courtyard 27:9-19**

The tabernacle courtyard was 50 cubits wide by 100 cubits long (75 feet by 150 feet, half the length of an American football field). This area is about the size of a modest home site in the United States. The curtains that formed its perimeter were only half as high as those surrounding the tabernacle structure (7 and a half feet instead of 15 feet). So the Israelites outside the courtyard could see the top part of the tabernacle.

"All its vessels were of copper-brass, which, being allied to the earth in both colour and material, was a symbolic representation of the earthy side of the kingdom of God; whereas the silver of the capitals of the pillars, and of the hooks and rods which sustained the hangings, as well as the white colour of the byssus-hangings, might point to the holiness of this site for the kingdom of God."<sup>3</sup>

"The whole arrangement of the outer court, and in particular the placement of the altar of sacrifice and the laver, speak pointedly of man's approach to God."<sup>4</sup>

---

<sup>1</sup>Meyer, p. 349.

<sup>2</sup>McGee, *Thru the ...*, 1:287.

<sup>3</sup>Keil and Delitzsch, 2:190.

<sup>4</sup>Davis, p. 263.

"... this structure provided the same kind of physical separation between the holy God and his people as did the mountain at Sinai (temporal separation is also provided in the annual feasts and celebrations, e.g., the yearly Day of Atonement, Lev 16)."<sup>1</sup>

"The court preserved the Tabernacle from accidental or intentional profanation, and it gave the priests a certain measure of privacy for the prosecution of their duties. Its presence was a perpetual reminder that man should pause and consider, before he rushes into the presence of the Most High [cf. Eccles. 5:2]."<sup>2</sup>

"The courtyard is the place of worship where the people could gather—they entered God's courts. Though the courtyard may not seem of much interest to current readers, it did interest the Israelites. Here the sacrifices were made, the choirs sang, the believers offered their praises, they had their sins forgiven, they came to pray, they appeared on the holy days, and they heard from God. It was sacred because God met them there; they left the 'world' (figuratively speaking) and came into the very presence of God."<sup>3</sup>

Following is a diagram of the "Ground Plan of the Tabernacle."<sup>4</sup> It effectively illustrates the symmetry of the whole tabernacle complex.

---

<sup>1</sup>Sailhamer, *The Pentateuch ...*, p. 298.

<sup>2</sup>Meyer, p. 348.

<sup>3</sup>*The NET2 Bible* note on 27:19.

<sup>4</sup>Adapted from Jacob Milgrom, *Leviticus 1—16*, p. 135.

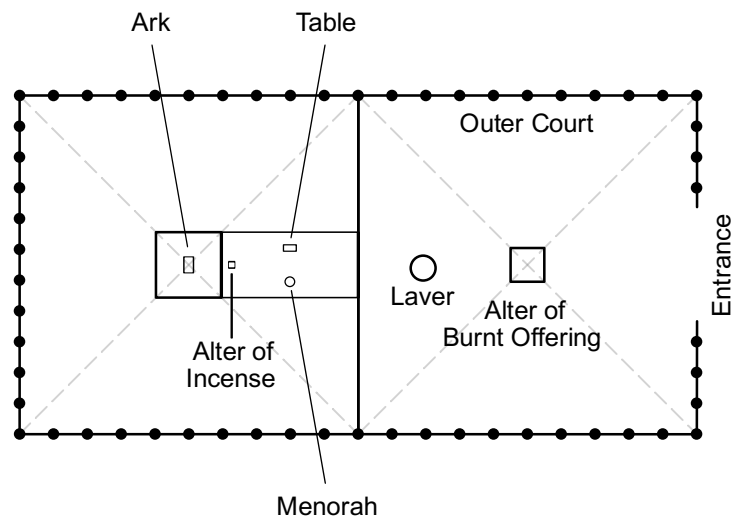

## 6. The investiture of the priests 27:20—28:43

Here begins the revelation of those things that related to the Israelites' relationship with God (27:20—30:38). The preceding section (25:10—27:19) emphasized the revelation of the things that revealed God's character. The priesthood is the primary revelation in this new section. The great amount of detail about the consecration of the priests suggests its importance and significance. The closer the physical relationship with God, the greater was the need for personal cleansing and holiness. This is a principle that we can learn from this section of Exodus. Leviticus will clarify this further.

"The approach to the Holy One, both within the biblical tradition and outside it, has always included some kind of mediatorial ministry, for it is inherent in any kind of 'high religion' that an otherwise unbridgeable chasm exist between ineffable deity and finite mankind.

"In earliest times, of course, Yahweh met directly with His creation, which in turn communicated with Him in word and act. With the passing of time and the rise of patriarchal familial and clan structures, the father of the household functioned also as its priest, the minister who stood between the family and its God. Finally—and even before the covenant at Sinai—



there had developed some kind of order of priests, as Exodus 19:22 expressly declares."<sup>1</sup>

The responsibilities of the priests in Israel fell into four primary categories:

1. They were responsible to maintain the holy place of the tabernacle. This included: burning incense each morning and evening, trimming and refilling the lamps each evening, and replacing the showbread each Sabbath.
2. The priests also maintained the tabernacle courtyard. This involved offering sacrifices each morning and evening, and blessing the congregation after the daily sacrifice. It also meant keeping the fire on the brazen altar always burning, and periodically removing its ashes.
3. They were also responsible to inspect and appraise people and sacrifices. These included lepers, wives accused of adultery, and things dedicated to the sanctuary, as well as the offerings that the people brought to the tabernacle.
4. Finally, the priests were to teach and counsel the people. They were to communicate and explain the Mosaic Law to the congregation, and decide difficult cases of law (cf. Lev. 11—27).

### The oil 27:20-21

These instructions concern the clear olive oil that the priests were to prepare for, and use in, the tabernacle lamps. They form a transition from an emphasis on the tabernacle furnishings to the priests' ministry that follows.

The priests had to trim the wicks and refill the oil in the lamps on the lampstand, in the holy place, every evening—to make them burn continually. Thus there was light in the holy place day and night (cf. Lev. 24:3; 1 Sam. 3:3).

"Oil ... is clearly a symbol of the Holy Spirit in Scripture."<sup>2</sup>

---

<sup>1</sup>Merrill, "A Theology ...," pp. 49-50.

<sup>2</sup>Davis, p. 264. See John F. Walvoord, *The Holy Spirit*, pp. 21-22; Ryrie, *The Holy ...*, p. 27.

"It was a favourite saying of [Robert Murray] M'Cheyne when discussing the method of pulpit preparation, that only beaten oil might be used in the sanctuary, intimating that careful preparation was required for all material presented for the consideration of our hearers. It is not a light thing to speak to men for God, and none of us should essay the holy task apart from very careful preparation; but when we have done our utmost in this, we must depend on the kindling of the Divine fire. Ours is the beaten oil at the best, but what is that, unless the High Priest Himself shall cause the lamp to burn?"<sup>1</sup>

The Spirit would, on the one hand, be a perpetual source of light for them. On the other hand, He would also empower God's people to be a perpetual light to the nations (cf. Isa. 42:6).

### The priests 28:1-5

Aaron had been functioning as a priest (Heb. *cohen*; 4:16). Now Moses officially appointed him and his sons to this office. God apparently specified Aaron as Israel's first high priest because he was the brother of Moses, whom God had already designated as the covenant mediator.<sup>2</sup> Josephus wrote that God chose Aaron because he was "the most righteous person among you" and "the most deserving of this honour."<sup>3</sup> But this seems unlikely in view of Aaron's character, as revealed more fully in later incidents.

Before the sinful priests could approach their holy God, they had to cover their uncleanness (sinfulness symbolically) with "holy garments" (v. 2). The priests had to wear these garments when they served in the tabernacle ritual, but they could not wear them at other times (35:19; Lev. 16:4, 23, 24). The fact that the workmen (tailors) who made these garments needed to be wise and skillful (v. 3) indicates the importance that God placed on their production.

Aaron's priesthood prefigured that of Jesus Christ (Heb. 5:5; 7:26; 9:11).

---

<sup>1</sup>Meyer, pp. 323-24.

<sup>2</sup>Merrill, "A Theology ...," p. 50.

<sup>3</sup>Josephus, *Antiquities of ...*, 3:8:1.

"And these garments speak of Christ. ... These garments were set apart for the service of God. Anything that is set apart for God is holy."<sup>1</sup>

### The ephod 28:6-14

The ephod (a transliteration of the Hebrew word) was the most important and outermost garment of the high priest. It was an apron-like piece of clothing, made of gold, and of violet and purple and scarlet material, that fit over his robe (cf. vv. 31-35).

"The duty of the high priest was to enter into the presence of God and make atonement for the people as their mediator. To show that as mediator he brought the nation to God, the names of the twelve tribes were engraved upon precious stones on the shoulders of the ephod. The precious stones, with their richness and brilliancy, formed the most suitable earthly substratum to represent the glory into which Israel was to be transformed as the possession of Jehovah (xix. 5); whilst the colours and material of the ephod, answering to the colours and texture of the hangings of the sanctuary, indicated the service performed in the sanctuary by the person clothed with the ephod, and the gold with which the coloured fabric was worked, the glory of that service."<sup>2</sup>

Josephus wrote that the names of Jacob's six oldest sons were on the stone on the right shoulder, and the names of his six youngest sons were on the stone on the left.<sup>3</sup> He also claimed that one of these stones shone when God was present at the sacrifice.<sup>4</sup> But this lacks any biblical support.

### The breastpiece 28:15-30

The breastpiece was attached to the ephod, forming a pocket about 9 inches square ("a span" by "a span," v. 16), and it was made of the same fabric as the ephod. Twelve precious stones, set in gold filigree (fine wire), were fastened to the front of the breastpiece, in four rows. The following

---

<sup>1</sup>McGee, *Thru the ...*, 1:288.

<sup>2</sup>Keil and Delitzsch, 2:195.

<sup>3</sup>Josephus, *Antiquities of ...*, 3:7:5.

<sup>4</sup>*Ibid.*, 3:8:9.

chart shows how 12 English translations render the Hebrew words that identify these stones:

A ruby, or carnelian, or red carnelian, or sardius	A topaz, or chrysolite	An emerald, or beryl, or carbuncle, or green felspar
A turquoise, or emerald, or purple garnet	A sapphire, or lapis lazuli	A diamond, or emerald, or chrysolite, or moonstone, or white moonstone, or jade
A jacinth, or turquoise	An agate	An amethyst, or jasper
A beryl, or chrysolite, or topaz	An onyx, or carnelian	A jasper, or green jasper

It is very hard to tell exactly what these stone were, as is clear from the differing translations of their Hebrew names. Two objects, the Urim (lit. "lights" or "curses") and the Thummim (lit. "perfections"), which were probably stones also, lay within the breastpiece.

The 12 jewels on the breastpiece represented the 12 tribes. Each one was unique: "extraordinary in largeness and beauty; and ... of ... immense value."<sup>1</sup> God later called the Israelites His jewels (Mal. 3:17). The high priest carried the tribes on his heart (v. 30) as well as on his shoulders, like Christ does for His people today. The heart, metaphorically speaking, refers to the seat of feelings and affections in the Old Testament, and the shoulders refer to strength.

"The purpose of the breastpiece was 'for making decisions' (v. 15). The Urim and Thummim, deposited in the pouch, were sacred lots used as the 'means of making decisions' (v. 30). The word 'Urim' begins with the first letter of the Hebrew alphabet and 'Thummim' begins with the last letter, so the lots were probably restricted to giving either positive or negative responses to questions asked of them. Strengthening that likelihood is the fact that the phrase 'Urim and Thummim' is

---

<sup>1</sup>Ibid., 3:7:5.

best translated into English as 'curses and perfections,' meaning that if 'Urim' dominated when the lots were cast the answer would be no but if 'Thummim' dominated the answer would be yes."<sup>1</sup>

"We possess as [Christian] believers a gift in us to guide and direct our steps; it is the Holy spirit. He is our Urim and Thummim."<sup>2</sup>

### The robe 28:31-35

The high priest also wore a robe, on which the ephod "vest" and attached breastpiece were both fixed in place. It was his basic outer garment, made all of blue, over which he put the ephod. This robe covered him completely, so that his natural nakedness was not exposed (cf. Gen. 3:21).

God may have intended the pomegranates and bells on the hem of the robe (vv. 33-34) to remind the Israelites of God's commandments. The pomegranate was probably a symbol of the spiritually nourishing quality of God's Word (cf. Prov. 25:11; Ps. 19:8-11; 119:25, 43, 50; Deut. 8:3; Prov. 9:8; Eccles. 12:9-11, 13). The bell was evidently a symbol of the sounding or proclamation of God's Word through testimony.<sup>3</sup> Some interpreters have felt that these pomegranates and bells represented fruitfulness and joy, respectively. Others have seen them as representing the fruits and gifts of God's Spirit. Josephus wrote that the bells signified thunder and the pomegranates lightning.<sup>4</sup>

"And these *bells*, like the bells in Zech. xiv. 20, speak to the ear, giving notice of his approach; while the *pomegranates* speak to the eye, telling that he comes laden with Canaan-fruit for those that hunger and thirst for righteousness."<sup>5</sup>

"A popular Jewish interpretation of 28:35 taught that one end of a long rope should be tied to the high priest's ankle before he entered the Holy Place. Since his slightest movement would

---

<sup>1</sup>Youngblood, p. 127.

<sup>2</sup>Gaebelein, 1:1:164.

<sup>3</sup>See Keil and Delitzsch, 2:202-203; G. Campbell Morgan, *An Exposition ...*, p. 45.

<sup>4</sup>Josephus, *The Wars of the Jews*, 5:5:7.

<sup>5</sup>Bonar, p. 158. Sailhamer, *The Pentateuch ...*, p. 306, recorded several other possible explanations of these decorations.

cause the bells to tinkle, the people outside would assume that all was well as long as they could hear them. But if the bells fell silent for a time, the people outside would naturally assume that their priest had either fainted or died. They would then tug on the end of the rope to pull him out, making it unnecessary for unauthorized persons to enter the Holy Place in order to remove his body."<sup>1</sup>

### The gold plate 28:36-38

A plate of pure gold was attached to the front of the high priest's turban. It bore the engraved words: "Holy to the LORD."

"Through this inscription, which was fastened upon his head-dress of brilliant white, the earthly reflection of holiness, he was crowned as the sanctified of the Lord (Ps. cvi. 16), and endowed with the power to exterminate the sin which clung to the holy offerings of the people on account of the unholiness of their nature, so that the gifts of the nation became well-pleasing to the Lord, and the good pleasure of God was manifested to the nation."<sup>2</sup>

"It was necessary also that he should be *a holy man*. ... It was as though they said: 'We are conscious that our representative may fail in personal holiness, but on that golden plate of purest metal we have placed our ideal, the high-water mark, which we desire our priest should attain.'"<sup>3</sup>

"'Set apart for Yahweh' refers not alone, indeed not even primarily to 'Aaron' and his successors, as v 38 makes plain. It is Israel that is 'set apart for Yahweh,' 'Aaron' of course [being] among Israel and representing Israel ..."<sup>4</sup>

---

<sup>1</sup>Youngblood, p. 128.

<sup>2</sup>Keil and Delitzsch, 2:204.

<sup>3</sup>Meyer, p. 359.

<sup>4</sup>Durham, p. 388.

### The tunic, turban, and sash 28:39

These items completed the high priest's official wardrobe. The tunic was an undergarment, the turban covered his head, and the sash served as a belt.

### The garments of the lesser priests 28:40-43

The clothing described in these verses (tunics, sashes, caps, and undergarments) appear to be the garments which the priests other than the high priest wore. All the priests ministered barefoot out of reverence for the holiness of God (cf. 3:5; Josh. 5:15).

"This prescription for undergarments alludes to and reminds one of the clothing which God made for Adam and Eve in the Garden of Eden to cover their nakedness (Ge 3:21)."<sup>1</sup>

"To us these garments typify, (1) The righteousness of Christ; if we appear not before God in this, we shall *bear iniquity and die*. (2) The armour of God prescribed, Eph. vi. 13."<sup>2</sup>

"The essential point of the priestly vestments is the central point of all the instructions concerning the media of worship: Yahweh is present, and Israel must respond to that Presence, be guided in that response, and be reminded constantly in worship as in life of the reality of the Presence and of the need for response."<sup>3</sup>

"God wanted no nudity in the service for Him (and we should keep this in mind for today). God wanted no display of the flesh."<sup>4</sup>

"There is much that can be derived from this chapter to form principles of spiritual leadership; but the overall point can be worded this way: Those whom God selects to minister to the congregation through intercessory prayer, divine counsel, and

---

<sup>1</sup>Sailhamer, *The Pentateuch ...*, p. 306.

<sup>2</sup>Henry, p. 103.

<sup>3</sup>Durham, p. 389.

<sup>4</sup>McGee, *Thru the ...*, 1:291.

sacrificial worship, must always represent the holiness of Yahweh in their activities and demeanor."<sup>1</sup>

### 7. The consecration of the priests 29:1-37

The Israelites carried out the instructions given here at a later time. The full record of this seven-day ritual appears in Leviticus 8. I shall defer comment on this chapter, since Moses explained the offerings and procedures, specified in this chapter, more fully in Leviticus. The fact that God specified this ceremony in such detail, and that Moses recorded it at such length, point to its importance for Israel and its instructive value for us.

"To Israel had been granted the privilege of being a special people; to Aaron and his sons was granted now the privilege of being a special mediating instrument between that people and Yahweh, their Lord. A covenant meal was always part of such an arrangement (cf. 24:11; 32:6), and that is precisely what is implied in the sharing of the ram of consecration by Yahweh and the priests."<sup>2</sup>

All the priests bathed (v. 4), representing the necessity of cleanliness before God.

"The washing is typical of regeneration [cf. Tit. 3:5]."<sup>3</sup>

The priests had sacrificial blood applied to their right earlobes, right thumbs, and right big toes (v. 20). This symbolized their complete consecration: to hear the word of God, to serve as mediators, and to walk as an example to others. They also experienced sprinkling with blood (v. 21), signifying their complete sanctification. Their anointing with oil (v. 21), that was also sprinkled on them, represented their endowment with power by God's Spirit for divine service. The "wave offering" (vv. 24, 26) consisted of waving an offering toward the altar and back, symbolically

---

<sup>1</sup> *The NET2 Bible* note on 28:43.

<sup>2</sup> Merrill, "A Theology ...," p. 51.

<sup>3</sup> McGee, *Thru the ...*, 1:292.



indicting that it was given to God and then received back by the priest for his use.<sup>1</sup>

"The investiture of the high priest consisted of nine acts (Lev. 8:7-9), whereas that of the ordinary priests involved but three."<sup>2</sup>

## **8. The service of the priests 29:38—30:38**

### **The daily burnt offering, meal offering, and drink offering 29:38-46**

The priests began to offer these sacrifices as soon as the tabernacle was completely constructed and set up (ch. 40).

Through the offering of a young lamb each morning and each evening—with flour, oil, and wine—the Israelites consecrated their lives afresh daily to the LORD. These were offerings of worship and expiation (i.e., the removal of sin, Lev. 1:4). It ensured Israel's continuing communion with her God.

"... thus the day was opened and closed with gifts to Yahweh, from whom all gifts were believed to come."<sup>3</sup>

### **The altar of incense and the incense offering 30:1-10**

God instructed Moses to place this altar in the holy place "in front of the veil that is near the ark of the testimony, in front of the atoning cover that is over the ark of the testimony" (v. 6). The placement of this altar in the tabernacle has been a problem for some readers of the Book of Hebrews. Hebrews 9:3-4 can be understood as describing its location as being inside the holy of holies—with the ark. But the writer of Hebrews undoubtedly meant that the "second veil" (Heb. 9:4, i.e., the veil that separated the holy place from the holy of holies) had the altar of incense and the ark of the covenant connected or associated with it. Both the ark, in the holy of holies, and the altar of incense, in the holy place, were next to the veil—one on either side of it.

Old Testament passages say that the incense altar was inside the holy place with the golden lampstand and the table of showbread (vv. 7-8; cf. 40:3-

---

<sup>1</sup>Kaiser, "Exodus," revised ed., p. 531.

<sup>2</sup>Davis, pp. 278-79.

<sup>3</sup>Durham, p. 396.

5, 21-27). Most commentators on Exodus also locate it in the holy place.<sup>1</sup> Furthermore, Leviticus 16:2 and Hebrews 9:7 say that the high priest went into the holy of holies only once a year on the Day of Atonement. Another view is that the altar of incense actually was in the holy of holies.<sup>2</sup> One writer believed that the writer of Hebrews described the altar of incense this way because, when he wrote, the veil between the holy place and the most holy place had been torn in two (when Christ died).<sup>3</sup>

The priests would offer incense on this altar each morning and each evening, and the incense would burn all the time. The priests presented the daily burnt offering and the daily incense offering together each day: "before sun-rising and at sun-setting," according to Josephus.<sup>4</sup> Both offerings were symbolic of constant, uninterrupted devotion to God. Students of Exodus have almost universally recognized the offered fragrant incense as a symbol of prayer that ascends to God (cf. Rev. 5:8). It was "a sweet aroma in His nostrils," and was essential to the maintenance of the divine-human relationship—just as talking to one's mate is essential to maintain the marriage relationship. Today, Jesus Christ ever lives to make intercession for believers (Heb. 7:25), and believers are to "pray without ceasing" (1 Thess. 5:17).

"Morning and evening prayers have been the habit of all ages. With the one we go forth to our labour till the evening, asking that our Father will give us His God-speed and guidance and protection. With the other we entreat forgiveness and mercy."<sup>5</sup>

"He who offers no sacrifice in his prayer, who does not sacrifice his self-will, does not really pray."<sup>6</sup>

---

<sup>1</sup>E.g., Cassuto, p. 391; Keil and Delitzsch, 2:208; Kaiser, "Exodus," p. 472; Hyatt, p. 292; Cole, p. 205; Ellison, p. 162; Maxie D. Dunnam, *Exodus*, p. 327; Hannah, p. 154; and Durham, p. 399. This is also the position of the writers of the articles on the tabernacle and the temple in *The New Bible Dictionary*, the *International Standard Bible Encyclopaedia*, and the *Wycliffe Bible Encyclopedia*.

<sup>2</sup>J. Dwight Pentecost, *A Faith That Endures: The Book of Hebrews Applied to the Real Issues of Life*, pp. 139-40.

<sup>3</sup>McGee, *Thru the ...*, 1:295.

<sup>4</sup>Josephus, *Antiquities of ...*, 3:8:3.

<sup>5</sup>Meyer, p. 375.

<sup>6</sup>*Ibid.*, p. 387.

"I have heard lots of people say, 'Now that I am saved, I can go directly to God.' No, you cannot! You go to God through Christ [1 Tim. 2:5]."<sup>1</sup>

Only priests were permitted to offer incense at this altar. Similarly, only priests can pray today, and every true believer is a priest. But only clean priests could and can offer acceptable prayers (vv. 17-20).

The horns of this altar (v. 10), as well as the horns on the altar of burnt offerings (the brazen altar), probably symbolized strength.<sup>2</sup>

Once a year Aaron applied the atonement blood (from the yearly sin offering) on this incense altar, in order to cleanse it afresh for another year (v. 10). The description "most holy to the LORD" means the altar could not be used for any other purpose than what is stated here.

The directions concerning the sanctuary (the tabernacle) conclude with this section.

### **The atonement money 30:11-16**

The directions regarding the tabernacle opened with instructions concerning contributions for its construction (25:1-9). They close with this directive that every Israelite, 20 years old and over, was to pay a flat fee of half a shekel during Israel's census. This money went for the tabernacle's maintenance (Num. 1:2; 26:2). Everyone was to pay the same amount, because the cost of everyone's atonement was the same in the LORD's sight.

"It was no ordinary tribute, therefore, which Israel was to pay to Jehovah as its King, but an act demanded by the holiness of the theocratic covenant. As an expiation for souls, it pointed to the unholiness of Israel's nature, and reminded the people continually, that by nature it was alienated from God, and could only remain in covenant with the Lord and live in His kingdom on the ground of His grace, which covered its sin."<sup>3</sup>

---

<sup>1</sup>McGee, *Thru the ...*, 1:295.

<sup>2</sup>Margit Sring, "The Horn-Motifs of the Bible and the Ancient Near East," *Andrews University Seminary Studies* 22:3 (Autumn 1984):334.

<sup>3</sup>Keil and Delitzsch, 2:212.

Israel's leaders collected this money whenever they took a census. In time, it became a yearly temple tax (Matt. 17:24). A half shekel weighed .2 ounces (6 grams), and it was a piece of silver. "Money" in verse 16 is literally "silver" in Hebrew. In our Lord's day, this tax amounted to two days wages. Evidently the taking of a census incurred some guilt (v. 12). Perhaps the census—unless specified by God—reflected a lack of complete trust in God to multiply the nation as He had promised (cf. 2 Sam. 24).

"Do you recognize that you belong to a redeemed world? Even if all do not avail themselves of the Redemption which has been achieved, yet it is available for all; and more benefits than we can ever estimate are always accruing since God so loved the world that He gave His only begotten Son."<sup>1</sup>

### The bronze basin 30:17-21

The basin ("laver" AV, NKJV) was a large reservoir for holding the water that the priests used to wash their hands and feet as they performed their duties. It stood between the bronze altar and the sanctuary. Its presence in that position symbolized the fact that cleansing is necessary after the making of atonement, but before the enjoyment of fellowship with God.

"God does not accept worship until it comes from a cleansed heart nor will He accept service except from a cleansed heart."<sup>2</sup>

"The necessity of daily cleansing on the part of those who are engaged even in the most holy service, and of all who would approach God, is so obvious as hardly to require comment. The body washed with pure water has for its counterpart the daily cleansing of the soul, without which no man may minister in the Divine presence [cf. John 13:10]."<sup>3</sup>

"In Scripture, water for *drinking* is a picture of the Spirit of God (John 7:37-39), while water for *washing* is a picture of the Word of God (Ps. 119:19; John 15:3; Eph. 5:25-27)."<sup>4</sup>

---

<sup>1</sup>Meyer, p. 391.

<sup>2</sup>McGee, *Thru the ...*, 1:297.

<sup>3</sup>Meyer, p. 351.

<sup>4</sup>Wiersbe, p. 237.

The "base" (v. 18, or "foot" AV, or "stand" NIV, TNIV, NRSV, ESV, HCSB, NET2, NEB, CEV) probably refers to the basin's supporting pedestal.

The priests washed their feet as well as their hands (v. 21). Both extremities obviously needed periodic cleansing, but the feet and hands probably also suggest the cleansing of the priest's going and coming as well as their work.

"When you go to church and do not enjoy the service, maybe it is not just because the preacher is dull. Maybe you are a dirty saint. When you have the combination of a dull preacher and a dirty saint, you do not have a very exciting service."<sup>1</sup>

### The holy anointing oil 30:22-33

The special mixture God specified here was for holy use only: in anointing the tabernacle, its furnishings, its utensils, and the priests. Four fragrant spices were blended with olive oil to produce a unique mixture, referred to as a "holy anointing oil" (v. 25). It was holy (different) in that the Israelites used it exclusively for this special purpose in the service of God. The priests were specifically told to use it for no other purpose in Israel (vv. 32-33).

"And inasmuch as this oil was composed of myrrh, cinnamon, calamus, and cassia (Exod. xxx. 25), the variety of the Holy Spirit's gifts and grace was shewn."<sup>2</sup>

### The holy incense 30:34-38

As with the holy anointing oil, only a specially prescribed mixture of four ingredients was acceptable for use as holy and fragrant incense for burning on the incense altar. Similarly, not just any prayer is acceptable to God; only prayers offered as He has instructed will be acceptable (cf. John 15:7; 16:24; 1 John 5:14).

"*Stacte* is a fragrant resin obtained from some species of cistus, or 'rockrose.' *Onycha* is the horny plate that covers a species of mussel found in the lakes of India which, when burned, emits a musky odor. *Galbanum* is a pleasantly aromatic gum resin derived from certain umbelliferous plants.

---

<sup>1</sup>McGee, *Thru the ...*, 1:296.

<sup>2</sup>Bonar, p. 166.

*Frankincense* (from the Old French for 'pure incense'), as used by the Jews, Greeks, and Romans, was a gum resin now called *olibanum* which was derived from certain trees of the genus *boswellia* found growing on the limestone of South Arabia and Somaliland. Thus, three of the four ingredients in the incense burned on the golden altar were *gum resins*. Gum resins are mixtures of gum and resin obtained from plants or trees by incision. Resins burn readily because they contain volatile oils."<sup>1</sup>

"The Bible names some of the 'ingredients' of prayer—adoration, confession, thanksgiving, petition, submission (1 Tim. 2:1; Phil. 4:6)—and even gives us a pattern to follow (Matt. 6:5-15)."<sup>2</sup>

### **9. The builders of the tabernacle 31:1-11**

Chapter 31 summarizes what God required for His people to approach Him: the tabernacle altars, furniture, regulations, and worship procedures; functions of the priests and their strict following of sacrifices and worship, including their holy garments, holy anointing with holy oil, and continual burning of holy incense; and the strict observance of the Sabbath by all Israelites. God appointed two specific and specially-gifted men who would be responsible, over all the skillful workmen, for interpreting Moses' instructions about the tabernacle, as well as constructing it. He also filled them with His Spirit, so that they would make choices consistent with His will (v. 3).

Bezalel ("In the Shadow of God"), a Judahite, was evidently Miriam's grandson.<sup>3</sup> Oholiab ("The Father is My Tent"), a Danite, was his assistant. God endowed both men with natural ability, as well as with the Holy Spirit, to do the work He had appointed for them (cf. Acts 6:3).

"Though they were skilled, the narrative emphasizes clearly that they were to do the work of building the tabernacle by means of the skills that the Spirit of God would give them. There is an important parallel here with God's work of Creation

---

<sup>1</sup>John V. Myers, "What Was 'Brimstone?'" *Kronos* 9:1 (Fall 1983):58.

<sup>2</sup>Wiersbe, p. 236.

<sup>3</sup>Josephus, *Antiquities of ...*, 3:6:1.

in Genesis 1. Just as God did his work of Creation by means of his Spirit (Ge 1:2—2:3), so also Israel was to do their work of building the tabernacle by God's Spirit.

"The parallels between God's work in Creation and Israel's work on the tabernacle are part of the Pentateuch's larger emphasis on the importance of the work of God's Spirit among his people. ... It is of interest here to note that the two key characters in the Pentateuch who provide a clear picture of genuine obedience to God's will, Joseph and Joshua, are specifically portrayed in the narrative as those who are filled with the Spirit of God (Ge 41:38; Dt 34:9)."<sup>1</sup>

### **10. The sign of the Sabbath 31:12-18**

"As a sign of the Noahic covenant is the rainbow (Gen. 9:13), and as the sign of the Abrahamic covenant is circumcision (Gen. 17:11), the sign of the Mosaic covenant is the observance and celebration of the Sabbath day (Exod. 31:13, 17)."<sup>2</sup>

God intended this sign, the Sabbath, to teach Israel and the other nations that, as His redeemed people, the Israelites had already entered into a measure of rest. They were partakers of God's rest.

Observance of the Sabbath was unique to Israel. It distinguished Israel from all other nations. So important was its observance that any Israelite who failed to observe it ("whoever does any work on it") died (v. 15).

"By not keeping the Sabbath, the Israelite was showing that he or she was not interested in 'know[ing] that I am the LORD.'"<sup>3</sup>

This sign was to continue "throughout your generations" (v. 13), namely, as long as God continued to work through Israel as His primary instrument (cf. Rom. 10:4; Heb. 9:10).

---

<sup>1</sup>Sailhamer, *The Pentateuch ...*, p. 309.

<sup>2</sup>Youngblood, pp. 112-13. The sign of the New Covenant is the Lord's Supper (Matt. 26:26-28; Mark 14:22-24; Luke 22:19-20; 1 Cor. 11:23-25).

<sup>3</sup>Enns, p. 545.

"I would like to ask the people who claim to keep the Sabbath if they keep it all the time. And are those of their number who do not keep the Sabbath all the time put to death as the law requires?"<sup>1</sup>

"The analogy between God's work of Creation and Israel's construction of the tabernacle is made explicit by the reference to the Sabbath at the close of the narrative."<sup>2</sup>

"The tabernacle is like no other place on earth. It is built according to a divine plan to reflect a heavenly reality. It is a piece of holy ground. To put it another way, the tabernacle is holy space. The Sabbath, by contrast is holy time. ... By entering the tabernacle, Israel entered God's house; by keeping the Sabbath, Israel entered God's rest."<sup>3</sup>

Whereas God has not commanded Christians to observe the Sabbath, the Scriptures do teach the importance of periodic physical rest—regardless of the dispensation in which they live (cf. Mark 6:31; 14:41; Rev. 6:11).

"We don't have to be servants twenty-four hours a day, seven days a week."<sup>4</sup>

This section concludes the record of all that Moses received from God, during the 40 days and 40 nights he was on the mountain, that began in 25:1 (v. 18). The two tablets that Moses received from the LORD were made of stone, to emphasize the permanence of the Word of God, and this "testimony" was written by "the finger of God." This is an anthropomorphism that emphasizes the direct activity of God in giving the commandments.

"Scholars of religion have long spoken of Israel's religious ideas as its unique contribution to civilization, much as the Greeks developed philosophy and the Romans displayed a genius for

---

<sup>1</sup>McGee, *Thru the ...*, 1:299.

<sup>2</sup>Sailhamer, *The Pentateuch ...*, p. 309.

<sup>3</sup>Enns, p. 546. Paragraph division omitted.

<sup>4</sup>John F. Alexander, "Sabbath Rest," *The Other Side* 146 (November 1983):8. See Jeffrey Siker-Gieseler, "The Theology of the Sabbath in the Old Testament: A Canonical Approach," *Studia Biblica et Theologica* 11:1 (April 1981):5-20, in which the author brought together and interpreted the references to the Sabbath in the Old Testament.



organization and empire-building. Yet such a comparison misses the point of Scripture. The Bible speaks not of the genius of Israel, but of the *finger of God*. The Ten Commandments were not the product of man, but the revelation of the Lord."<sup>1</sup>

Moses wrote the instructions concerning the tabernacle so that they parallel what he wrote about the Creation. Note some of the similarities in the narratives.<sup>2</sup>

Creation (Gen. 1—2)	Tabernacle (Exod. 25—31)
The subject of the narrative is the establishment of God's good creation.	The subject of the narrative is the re-establishment of God's good creation.
The heavens and earth are the arena for the creation of divine-human fellowship.	The tabernacle is the arena for the restoration of divine-human fellowship.
God's Spirit was the enabling power in creation (Gen. 1:2—2:3).	God's Spirit was the enabling power in the construction of the tabernacle (Exod. 31:3, 6).
Structurally, the creation account consists of seven acts each marked by divine speech ("And God said," Gen. 1:3, 6, 9, 14, 20, 24, 26).	Structurally, the tabernacle account consists of seven acts each introduced by divine speech ("And the LORD said," Exod. 25:1; 30:11, 17, 22, 34; 31:1, 12).
God made Adam and Eve according to a specific pattern: the image of God (Gen. 1:26-27).	Moses made the tabernacle according to a specific pattern: a heavenly reality (Exod. 25:9).
The Garden of Eden contained gold and jewels, and cherubim guarded it (Gen. 2:12a, 12b; 3:24).	The tabernacle contained gold and jewels, and cherubim guarded it (Exod. 25:3, 7, 18).

<sup>1</sup> *The Nelson ...*, p. 156.

<sup>2</sup> Adapted from Sailhamer, *The Pentateuch ...*, pp. 289-90, 306, 309.

When creation was complete, God inspected and evaluated all that He had done (Gen. 1:31) and uttered a blessing (Gen. 1:28).	When the tabernacle was complete, Moses inspected and evaluated all that was done (Exod. 39:43a) and uttered a blessing (Exod. 39:43b).
God rested on the seventh day at the end of the creation narrative (Gen. 2:1-3).	God told the Israelites to rest on the seventh day at the end of the tabernacle narrative (Exod. 31:12-18).
A fall followed the creation narrative (Gen. 3).	A fall followed the tabernacle narrative (Exod. 32).
This fall resulted in the breaking of the Edenic Covenant (Gen. 3:14-19).	This fall resulted in the breaking of the Mosaic Covenant (Exod. 33:1-5).
God covered Adam and Eve's nakedness (Gen. 3:21).	God ordered the covering of the priests' nakedness (Exod. 28:42).

#### **D. THE BREAKING AND RENEWAL OF THE COVENANT CHS. 32—34**

"If a narrative paradigmatic [model] of what Exodus is really about were to be sought, Exod 32—34 would be the obvious first choice. That these chapters are paradigmatic of Israel's relationship with Yahweh throughout the OT is also obvious, and the farthest thing from coincidence."<sup>1</sup>

##### **1. The failure of Israel ch. 32**

The scene now changes, and we see what was happening down in the Israelite camp, while Moses was still up in the heights of Sinai receiving the instructions for the Israelites' worship. The people were already apostatizing (renouncing their beliefs) and were devising their own form of worship.

---

<sup>1</sup>Durham, p. 418. Paragraph division omitted.

### Israel's apostasy 32:1-6

The word apostasy literally means "to stand away from" (Gr. *apostasis*). This word describes a departure from some previous position. An apostate is someone who renounces a former belief or principle. In the religious sense, the word refers to someone who abandons or departs from God's will. "Apostate" is not necessarily a synonym for "unbeliever." The person who departs from God's will could be either a believer or an unbeliever. The term, in the religious sense, relates to obedience, not salvation. Most of the apostates in Israel were apparently believers, since the Bible consistently regards Israel—as a whole—as the people of God. The great majority of Israelites at Mt. Sinai had been redeemed in the Exodus. They had expressed saving faith by applying the blood on their doorframes on the night of the Passover.

"Throughout the remainder of the Pentateuch, the incident of the worship of the golden calf cast a dark shadow across Israel's relationship with God, much the same way as the account of the Fall in Genesis 3 marked a major turning point in God's dealing with humankind."<sup>1</sup>

"This is the first general act of disobedience on the part of Israel, the nation that had committed itself to being God's people and obeying him (Ex. 19:8[; 24:3, 7]). Often the first act of disobedience receives full judgment so that every one [*sic*] can know God's view of the matter (e.g., Achan in Joshua 7, and Ananias and Sapphira in Acts 5). Many were killed, and in Exodus 32:34 God refers to a 'day' when he will punish wrongdoers."<sup>2</sup>

It has always been hard for God's people to wait for Him (cf. 1 Sam. 8:4-5; Ps. 27:14; 37:7; 62:5; et al.). When Moses delayed (v. 1)—from the people's perspective, not by his own choice but following God's timetable—on the mountain, the people decided to worship "a god" and make a new covenant. They did not wait for guidance from God. This reflects a shallow commitment both to Him and to their human leader, Moses.

---

<sup>1</sup>Sailhamer, *The Pentateuch ...*, p. 310.

<sup>2</sup>Bramer, p. 94.

"Misinterpretations of our Redeemer's delays are the occasion of a great deal of wickedness. Our Lord Jesus has gone up into the mount of glory, where he is appearing in the presence of God for us, but out of our sight; the heavens must contain him, must conceal him, that we may live by faith. Weariness in waiting betrays us to a great many temptations."<sup>1</sup>

Perhaps the people concluded that Moses had perished in the fire on Mt. Sinai.. Moses was "as God" to Israel in the sense that he was their leader (4:16); he stood in God's place in relationship to them. Now they turned from Moses, as their leader, to Aaron.

"Much is being said these days about 'meeting the felt needs of people,' but here was a nation that didn't know what its needs really were. They thought they needed an idol, but what they really needed was faith in their great God who had revealed Himself so powerfully to them."<sup>2</sup>

"The example of the Israelites shows the origin of idolatry to be that men do not believe God is with them unless he shows himself physically present."<sup>3</sup>

There is some question as to whether Aaron intended the golden calf to represent a god other than Yahweh or Yahweh Himself. Arguments for the latter view follow:

"... when the god was represented in human form, it served as a podium, but it is also found [in ancient Near Eastern culture] on its own as a symbol of the deity."<sup>4</sup>

"In the present passage the term *gods*, or rather *god* [Elohim], represented in the golden calf, seems to be understood as an attempt to represent the God of the covenant with a physical image. The apostasy of the golden calf, therefore, was

---

<sup>1</sup>Henry, p. 106.

<sup>2</sup>Wiersbe, p. 245.

<sup>3</sup>Calvin, 1:11:8.

<sup>4</sup>Eichrodt, 1:117.

idolatry, not polytheism. Indeed, throughout Scripture Israel was repeatedly warned about the sin of idolatry."<sup>1</sup>

"It is precisely the attempt to worship *Yahweh* by means he has already declared totally unacceptable that makes the sin of the golden calf so destructive, far more so than a simple shift of allegiance to 'other' or 'foreign' gods."<sup>2</sup>

The other view is that the people were asking for another "god," not the true God.<sup>3</sup>

"Imagine the first high priest making an idol!"<sup>4</sup>

Perhaps both views are correct, since various speculations were likely present in such a large population.

"From Aaron's viewpoint it was merely a matter of iconography, representing God by a bull and in that way holding 'a festival to / *AM*' (Exod. 32:5). But from the people's viewpoint, as seen from the command to Aaron 'make us gods' (v. 1), they were turning to a pantheon of gods, represented by a bull god, to lead them."<sup>5</sup>

I prefer the first view.

"It is commonly accepted by Old Testament scholars today that the ancients did not *equate* an idol with the god, but it was some sort of earthly *representation* of that god. Specifically, it was thought that calves or bulls functioned as pedestals for the gods seated or standing over them. In this sense, the calf is analogous to the ark (the fact that both are made of gold strengthens this connection)."<sup>6</sup>

---

<sup>1</sup>Sailhamer, *The Pentateuch ...*, p. 311. See also Henry, p. 106; Keil and Delitzsch, 2:222; Jamieson, et al., p. 79; David E. Fass, "The Molten Calf: Judgment, Motive, and Meaning," *Judaism* 39:2 (Spring 1990):171-83.

<sup>2</sup>Durham, p. 421.

<sup>3</sup>*The Nelson ...*, p. 156.

<sup>4</sup>Wiersbe, p. 398.

<sup>5</sup>Waltke, *An Old ...*, p. 469.

<sup>6</sup>Enns, p. 569.

"When Aaron made the golden calf in the wilderness and said to the people, 'These be thy gods, O Israel, which brought thee up out of the land of Egypt' (Exod. 32:4), both Aaron and the people knew that this calf, which they had seen made before their eyes, was not God, nor had it brought them out of Egypt—rather they had brought it out in the form of earrings. But by the consecration of that calf they believed that God was present in it, and they worshipped God under the appearance of the calf. But God would not be identified with it, and judged them for idolatry. Even the heathen do not profess to worship stones and trees, but the spirits identified with them. And the attempt to worship God under any species is pure idolatry."<sup>1</sup>

The golden calf provided a visible symbol that the Israelites could and did identify with their Deliverer ("This is [represents] your god [Heb. *Elohim*, the Strong One], Israel, who brought you up from the land of Egypt." v. 4). The English word idol derives from the Greek *eidolon*, meaning "something to be seen." The Apis bull was such a symbol in Egyptian religion. The Egyptians viewed this animal, the bull, as the vehicle on which a god rode in power, and as such they identified it as divine itself. Sacred bulls or calves were common in the ancient Near East because of this identification.<sup>2</sup> Patterning their worship of Yahweh after the Egyptians' worship of their god of the sun, Osiris, the Israelites were saying—by rising early, sacrificing animals, sitting down to eat and drink, and engaging in "lewd behavior" (v. 6)—that this was their way of worshipping Yahweh.

"The bull seems to have had manifold meanings in the iconography of the Near East. It symbolized the god. It expressed attributes of a god. It represented a pedestal for the god. Each of these meanings is important in understanding the cult of the golden calves in Israel's religious experience."<sup>3</sup>

Some commentators have interpreted Aaron's instruction, that the Israelites should sacrifice their jewelry and ornaments (v. 2), as designed

---

<sup>1</sup>J. C. Macaulay, *The Bible and the Roman Church*, p. 51.

<sup>2</sup>See Velikovsky, pp. 188-91.

<sup>3</sup>Stephen Von Wyrick, "Israel's Golden Calves," *Biblical Illustrator* 13:1 (Fall 1986):10. This is a very fine summary article. See also Amihai Mazar, "Bronze Bull Found in Israelite 'High Place' From the Time of the Judges," *Biblical Archaeology Review* 9:5 (September-October 1983):34-40.

to discourage their rebellion.<sup>1</sup> If this was his intent, he failed (v. 3). It seems more probable, going by a normal reading of the text, that Aaron approved of their plan. Aaron later tried to pass the blame on to the people, rather than admitting his own complicity in this sin (vv. 22-24). Compare Adam's weak reply to God in Genesis 3:12.

The altar and the feast that accompanied the construction of the idol (v. 5), support the contention that Aaron was leading the people in a celebration of a new covenant.

"That the sin of Aaron and the people was tantamount to covenant repudiation is clear from the account of the making of the calf. The calf was hailed as 'the god ... who brought you up out of Egypt' (Ex. 32:4), the exact language of the historical prologue of the Sinaitic Covenant in which Yahweh described the basis of His authority to be Israel's God (20:2). Moreover, Aaron built an altar for the purpose of covenant affirmation and ceremony (v. 5), precisely as Moses had done previously on the people's commitment to the covenant arrangement (24:4). Aaron's proclamation concerning a festival and its implementation on the following day (32:5-6) was again identical to the celebration that attended the mutual acceptance of the covenant terms under Moses (24:11)."<sup>2</sup>

Aaron led the people in breaking the second commandment: They had made a graven image to represent Yahweh (cf. 20:4-6). Aaron's disobedience to the second commandment (20:4-6), which he had received by this time, resulted in his returning to an Egyptian form of worship that repudiated Yahweh's will.

The lewd behavior that followed the feast seems to have been wicked, involving sexual immorality (cf. 1 Cor. 10:7-8). The people were "out of control," (v. 25, or "naked" AV, or "running wild" NET2, NRSV, NIV, TNIV, or "broken loose" ESV, or "unrestrained" HCSB). The Hebrew word used to describe the people is difficult to translate.

"The verb translated 'to play' ["engage in lewd behavior," v. 6, NASB] suggests illicit and immoral sexual activity which

---

<sup>1</sup>See Kennedy, p. 138; Meyer, p. 421; Benno Jacob, p. 940.

<sup>2</sup>Merrill, "A Theology ...," p. 53.

normally accompanied fertility rights found among the Canaanites who worshipped the god Baal."<sup>1</sup>

God's intent was that His people worship Him at the altar revealed to Moses, not at an altar constructed by Aaron. God's intent was to dwell among His people above the golden mercy seat (atonement cover) on top of the ark, not on top of a golden calf. It was His intent that His people celebrate the feasts that He prescribed, not a feast involving pagan revelry. God's intent was that Moses should lead the people, not Aaron. Some of God's intentions had not yet been revealed to the people; Moses was still on the mountain receiving these instructions. Their failure was running ahead of God in most of what they did. They erred also in determining how Yahweh was to be worshipped (like their neighbors worshipped), rather than worshipping God as He dictated.

"The calf represented Yahweh on *their* terms. Yahweh had made clear repeatedly that he would be received and worshiped only on *his* terms."<sup>2</sup>

Many years later, Israel's King Jeroboam I re-established the worship of the golden calves, and this practice became a great stumbling-block to Israel (1 Kings 12:28-31).

### **Moses' intercession 32:7-14**

God's recounting to Moses the news of the golden calf gives the reader the divine perspective on Israel's sin. Moses stressed three points in this pericope:

"These three points—idolatry of the golden calf, Israel's stiff-necked refusal to obey, and God's compassion—provide the basis of the subsequent narratives and God's further dealings with this people. Though a great act of God's judgment follows immediately (vv. 27-35), the central themes of the subsequent narratives focus on God's compassion and a new start for Israel."<sup>3</sup>

---

<sup>1</sup>Davis, p. 285.

<sup>2</sup>Durham, p. 442.

<sup>3</sup>Sailhamer, *The Pentateuch ...*, p. 312.



God called the Israelites Moses' people (v. 7), probably because they had repudiated the covenant, and God was therefore no longer their God in the sense that He had been. God regarded the Israelites' sacrificing before the calf as worship of it (v. 8). This constituted a violation of the first commandment.

"... just as soon as a visible form had been fashioned for God, his power is also bound to it. Men are so stupid that they fasten God wherever they fashion him; and hence they cannot but adore. And there is no difference whether they simply worship an idol, or God in the idol. It is always idolatry when divine honors are bestowed upon an idol, under whatever pretext this is done."<sup>1</sup>

God proposed to destroy the rebellious Israelites, and to make Moses' descendants into a great nation (v. 10). He may have meant that He would only destroy that older generation of Israelites immediately, instead of over the next 40 years, rather than wiping out the entire nation. God was proposing an action that would have been consistent with His promises to the patriarchs and the conditions of the Mosaic Covenant (cf. Num. 14:12).

This proposal constituted a test of Moses' ministry as Israel's mediator. For Moses this test was real, even though the proposed destruction of Israel lay outside God's plan (cf. the promises to Abraham; Gen. 49:10). Similarly, God had told Abraham to offer up Isaac, even though He had previously told him that Isaac would be his designated heir. And Jesus would later offer Himself to Israel as her King, even though His death on the cross, according to the predetermined plan and foreknowledge of God (Acts 2:23), had to precede the establishment of His kingdom.

Moses passed the test. He did not forsake his people, but instead urged God to have mercy on them.

"Earlier in Exodus Moses argued with God out of his own selfish, almost petty motives (3:11—4:17). Now, however, he argues with God on behalf of the people—he has learned to put their interests first."<sup>2</sup>

---

<sup>1</sup>Calvin, 1:11:9.

<sup>2</sup>Enns, p. 572.

In his model intercessory prayer (vv. 11-13), Moses appealed to God on the basis of several things: God's previous work for Israel (v. 11), God's glory and reputation (v. 12), and God's word (v. 13).

The reference to God relenting (v. 14) has been a problem to many Bible readers. The expression implies no inconsistency or mutability in the character of God. He does not vacillate, but always does everything in harmony with His own character. Within the plan of God, however, He has incorporated enough flexibility so that, in most situations, there are a number of options that are acceptable to Him. In view of Moses' intercession, God proceeded to take a different course of action than He had previously intended.<sup>1</sup>

Ephesians 1:11 says that God causes everything to work out the way He wants it to (cf. Rom. 8:28). He foreordains *what* comes to pass, but Scripture doesn't say that He foreordains *how* everything will come to pass, or *when* it will come to pass, or *by whom* it will come to pass. Prayer and evangelism are two of the means that God has ordained, that is, human activity, whereby *what* He has foreordained comes to pass. In these activities, people become partners with God in bringing His will to happen in the world.

Occasionally, my wife has called me at work and asked me to pick up a gallon of milk on my way home. When this happens, I take a different route than I would normally take, but I end up at home nonetheless. Perhaps this is similar to how our praying affects God as He accomplishes His will.

"In only two of the thirty-eight instances in the OT is this [Hebrew] word [translated "relent"] used of men repenting. God's repentance or 'relenting' is an anthropomorphism (a description of God in human forms [*sic* form]) that aims at showing us that he can and does change in his actions and emotions to men when given proper grounds for doing so, and thereby he does not change in his basic integrity or character (cf. Pss 99:6; 106:45; Jer 18:8; Amos 7:3, 6; Jonah 3:10; James 5:16). The grounds for the Lord's repenting are three: (1) intercession (cf. Amos 7:1-6); (2) repentance of the

---

<sup>1</sup>See John Munro, "Prayer to a Sovereign God," *Interest* 56:2 (February 1990):20-21; Thomas L. Constable, "What Prayer Will and Will Not Change," in *Essays in Honor of J. Dwight Pentecost*, pp. 99-113; Robert B. Chisholm Jr., "Does God 'Change His Mind'?" *Bibliotheca Sacra* 152:608 (October-December 1995):387-99; Hannah, p. 156.

people (Jer 18:3-11; Jonah 3:9-10); and (3) compassion (Deut 32:36; Judg 2:18; 2 Sam 24:16[; 1 Chron. 21:15])."<sup>1</sup>

Advocates of the "openness of God" theory overemphasize this change in God, and conclude that He did not simply relent from a previously proposed course of action, but changed in a more fundamental way. They say that He actually changed His mind and His plans, and took a completely different direction that He had not foreknown previously. This view stresses the free will of man—in this case Moses' intercession—at the expense of the omniscience and sovereignty of God.

### **Aaron's excuse 32:15-24**

Possibly the singing of the people (v. 18) was like their singing when they had crossed the Red Sea (ch. 15): not just happy singing, but singing in praise of their "deliverer."<sup>2</sup>

Moses shattere the tablets of the law (v. 19), symbolizing the fact that Israel had broken its covenant with Yahweh. He then proceeded to destroy the golden calf, the symbol of the illicit covenant into which they had entered (cf. 2 Kings 23:15). By treating the calf image as he did, Moses was dishonoring as well as destroying it (v. 20).

"... the biblical description of the destruction of the Golden Calf constitutes an Israelite development of an early literary pattern that was employed in Canaan to describe the total annihilation of a detested enemy."<sup>3</sup>

Moses probably ordered the people to drink the polluted water for the following reason:

"... to set forth in a visible manner both the sin and its consequences. The sin was poured as it were into their bowels along with the water, as a symbolical sign that they would have to bear it and atone for it, just as a woman who was suspected

---

<sup>1</sup>Kaiser, "Exodus," p. 479. See Tozer, *The Knowledge ...*, pp. 55-60, for a good discussion of the immutability (unchangeability) of God.

<sup>2</sup>Enns, p. 573.

<sup>3</sup>Samuel Loewenstamm, "The Making and Destruction of the Golden Calf," *Biblica* 48 (1967):485.

of adultery was obliged to drink the curse-water (Num. 5:24)."<sup>1</sup>

"In this manner the thing they had worshiped would become a product of their own waste, the very epitome of worthlessness and impurity."<sup>2</sup>

Some writers have suggested that this water, with the gold dust suspended in it, would have been red, and is a type of the blood of Christ.<sup>3</sup> This view lacks support in the text. The writer said nothing about Moses offering it to the LORD to make atonement for the sins of the Israelites. The people drank it as a punishment; they did not offer it to God.

Aaron tried to shift the blame for his actions to the people (vv. 22-23; cf. Gen. 3:12-13).

"A woman of society and fashion will say, 'I admit that I am not what I might be, but then look at my set; it is the furnace that did it.' A man will doubt God, question the Bible and truth, and excuse himself by saying, 'It is not I, it is the drift of modern tendency; it is the furnace that did it.' 'There came out this calf.'"<sup>4</sup>

Verse 24 suggests that Aaron may have formed the calf by casting it in a mold, but verse 4 gives the impression that he carved it out of a shapeless mass. The best solution seems to be that Aaron crafted this calf like similar Egyptian calf-idols were produced. He probably built a wooden frame and then overlaid it with gold that he shaped (cf. Isa. 30:22).<sup>5</sup>

### The Levites' loyalty 32:25-29

The Levites were Moses' closest kinsmen. Perhaps it was for this reason, as well as their loyalty to the LORD, that they sided with Moses on this occasion. Their decision and obedience demonstrated their faith in God.

---

<sup>1</sup>Keil and Delitzsch, 2:226.

<sup>2</sup>Merrill, *Deuteronomy*, p. 196. Cf. Benno Jacob, p. 950.

<sup>3</sup>E.g., M. R. DeHaan, *The Chemistry of the Blood and Other Stirring Messages*, pp. 61-63.

<sup>4</sup>Meyer, p. 422.

<sup>5</sup>See Samuel Loewenstamm, "The Making and Destruction of the Golden Calf—a Rejoinder," *Biblica* 56 (1975):330-43; Stanley Gevirtz, "Heret in the Manufacture of the Golden Calf," *Biblica* 65 (1984):377-81.

They chose to go the way of His appointed leader, Moses, instead of following their rebellious brethren.

God's punishment of the rebels was severe (v. 27) because of the seriousness of their offense. It was also merciful; only 3,000 of the approximately 600,000 men died (v. 28).

It is interesting that on the Day of Pentecost 3,000 people were saved (Acts 2:41). "The letter kills, but the Spirit gives life" (2 Cor. 3:6).

The Levites' blessing was God's later choice of their tribe to be the priestly tribe in Israel (Num. 3:12-13). The nation as a whole forfeited its right to be "a kingdom of priests" (19:6) by its rebellion here. By contrast, all Christians are "priests" (1 Pet. 2:5). This difference is one indication that the church does not replace Israel in the plan of God.

"The idiom 'fill the hands' [the literal meaning of "dedicate yourselves," NASB, or "you have been set apart," NIV, v. 29] means 'institute to a priestly office,' 'install,' 'inaugurate,' and the like."<sup>1</sup>

### **Moses' second intercession 32:30-35**

To make atonement (v. 30) means "to obtain a covering for sin."

We see Moses' great love for the Israelites, as their mediator, in his willingness to die for them (cf. Rom. 9:3). Being wiped out of God's book (v. 32) probably refers to physical death. Alternatively, the "book" could refer to the register of those loyal to Yahweh, and thereby deserving His special blessing (cf. Ps. 69:28; Isa. 4:3; Ezek. 13:9; Dan. 12:1; Mal. 3:16).<sup>2</sup> God explained a principle of His dealings with people here: individual sin brings individual responsibility, that, in the end, leads to individual judgment (v. 33; cf. Ezek. 18:4). God was not saying that everyone will bear the punishment for his own sins, precluding substitution, but that everyone is responsible for his own sins. He chose not to take Moses' life as a substitute for the guilty in Israel, since that would not have been just. Moses, being a sinner himself, could not have served as a final, acceptable substitute for other sinners.

---

<sup>1</sup>Hyatt, p. 310.

<sup>2</sup>Durham, p. 432.

God promised Moses that He would not abandon His people for their sin (v. 34), but He would punish them for their rebellion (v. 34). Apparently shortly thereafter, God sent a plague on the people that destroyed many of the calf worshippers (v. 35). The Apostle Paul, referring back to this incident, wrote that "twenty-three thousand fell in one day" (1 Cor. 10:8).<sup>1</sup>

## 2. The re-establishment of fellowship ch. 33

Breaking God's covenant resulted in the Israelites' separation from *fellowship* with Him, but it did not terminate their *relationship* with Him. Similarly, when Christians sin, we do not cease to be God's people, but our fellowship with the Lord suffers.

"Moses had now returned to Mount Sinai and there God spoke with him again. The text has several indications that the author now wants to show that Israel's relationship with God had been fundamentally affected by their 'great sin' of worshiping the golden calf. All was not the same. The narrative shows that there was now a growing distance between God and Israel that had not been there before. Each of the following sections of narrative demonstrates specifically the changes that have occurred in God's relationship to Israel. We should also note that the Levites are chosen in this narrative; in Numbers 3 they replace the firstborn Israelites as priests. This represents a further change in Israel's relationship with God in the Sinai covenant."<sup>2</sup>

Notice some comparisons and contrasts, between the narrative of the original giving of the covenant, and this narrative that describes the renewal of the covenant.<sup>3</sup>

---

<sup>1</sup>See Jonathan Master, "Exodus 32 as an Argument for Traditional Theism," *Journal of the Evangelical Theological Society* 45:4 (December 2002):585-98.

<sup>2</sup>Sailhamer, *The Pentateuch ...*, p. 313.

<sup>3</sup>Adapted from *ibid.*, pp. 313-17.

The Giving of the Covenant (Exod. 20—31)	The Restoring of the Covenant (Exod. 33—34)
All the people were to be priests (19:5-6).	Only the Levites would be priests (32:29).
Moses ascended Mt. Sinai and God spoke with him there while the people waited below (19:20).	Moses ascended Mt. Sinai and God spoke with him there while the people waited below (32:31).
God sent His angel to destroy Israel's enemies (23:23).	God sent His angel lest He destroy Israel (33:2-5).
The tabernacle in the center of the camp was to be the "tent of meeting" where God would meet with the people (25:8; 27:21; 28:43; 29:42-43).	Another "tent of meeting" outside the camp was where God met with Moses and Joshua only (33:7).
God displayed His glory for all the people to see on Mt. Sinai (24:16-17).	Only Moses could see God's glory partially (33:18-23), and the people only saw God's glory reflected on Moses' face (34:29).
God covered Moses' face lest he see too much of God's glory (33:18-23).	Moses covered his face lest the people see too much of God's glory (34:34-35).
God revealed His glory to test the people and to keep them from sinning (20:20).	God revealed His glory to show His grace and compassion (33:19; 34:6-7).
God wrote the Ten Commandments on stone tablets (Deut. 10:1-4).	God wrote the Ten Commandments on stone tablets (34:28).
God gave the Ten Commandments (20:2-17).	God gave the Ten Commandments (34:27-28).
The structure of the narrative begins and ends with warnings against idolatry (20:22-23; 23:13)	The structure of the narrative begins and ends with warnings against idolatry (34:11-17) and

and instructions for proper worship (20:24-26; 23:14-19).	instructions for proper worship (34:11-26).
Moses expressed amazement when he saw the people (32:19).	The people expressed amazement when they saw Moses (34:30).

33:1-6 God would not now dwell in the midst of the Israelites, as He intended to do in the tabernacle, because they had repudiated His covenant with them (v. 3).

The announcement of the change in God's relation to Israel, and the consequent loss of blessing, led the people to mourn and sacrifice out of sorrow (vv. 4-6). They willingly gave up the use of, and stopped wearing, their remaining jewelry, in response to God's command. This probably symbolized their humiliation.

33:7-11 The tent referred to here, called "the tent of meeting," cannot be the tabernacle, since the Israelites had not yet built it. It must have been a smaller tent that was used as a meeting place for Moses, the people, and God—over which the pillar of cloud was would descend. This tent served some of the functions of the tabernacle, which later replaced it. Moses at this point moved this tent of meeting outside the camp, to symbolize the removal of God's presence from the people's midst.<sup>1</sup> Even though God moved away from the people, He did not abandon them. As mentioned above, believers' sinful conduct breaks their fellowship with God, but not their relationship with God.

Moses' personal communion with God was uncommonly intimate (v. 11; cf. Num. 12:6-8). One writer believed that the cloud was Jesus.<sup>2</sup> That is, that Jesus was in the cloud. Durham believed that "face to face" (v. 11) is an idiom that communicates intimacy, not a theophany.<sup>3</sup> However, Moses

<sup>1</sup>See Henry Mowvley, "John 1:14-18 in the light of Exodus 33:7—34:35," *The Expository Times* 95:5 (February 1984):135-37.

<sup>2</sup>Ronald B. Allen, "The Pillar of the Cloud," *Bibliotheca Sacra* 153:612 (October-December 1996):393.

<sup>3</sup>Durham, p. 443.



probably spoke face to face with the angel of the LORD (the pre-incarnate Christ; cf. Gen. 18:1; Josh. 5:13-15; et al.).<sup>1</sup>

"Now daily oracles are not sent from heaven, for it pleased the Lord to hallow his truth to everlasting remembrance in the Scriptures alone [cf. John 5:39]."<sup>2</sup>

33:12-16 God's withdrawal from Israel created problems for Moses as Israel's mediator. If God was not going to enter into covenant relationship to Israel, as He had first described (13:21-22), how could Moses lead the nation (cf. 3:11, 13)? This is the focus of Moses' first request ("Let me know Your ways, so that I may know You," in other words, "Tell me what You want from me, plus all Your plans and intentions, and how I can successfully lead Your people," v. 13). He wanted reassurance that God Himself would lead Israel in the wilderness.<sup>3</sup>

"Thus our Lord Jesus, in his intercession, presents himself to the Father, as one in whom he is always well pleased, and so obtains mercy for us with whom he is justly displeased; and we are *accepted in the beloved*."<sup>4</sup>

God assured Moses that He would continue to go with His people, and would provide them with rest (v. 14). As used elsewhere, this "rest" is not peace of mind but freedom from engaging enemies in war (cf. Deut. 3:20; 12:10; 25:10).

Moses' second request was that God would confirm him as God's chosen mediator among the Israelites and that God would confirm the nation as His chosen people—in view of the change in the relationship (v. 16).

33:17-23 God promised to grant these requests too (v. 17). Knowing Moses by his name implied having chosen Moses.

---

<sup>1</sup>McGee, *Thru the ...*, 1:305.

<sup>2</sup>Calvin, 1:7:1.

<sup>3</sup>Durham, p. 446.

<sup>4</sup>Henry, p. 109.

Third, Moses requested a greater perception of God's essential being than he had experienced thus far ("Please, show me Your glory!" v. 18). This would also enable him to serve God more effectively, in view of his altered relationship with God. God promised to reveal Himself more fully to Moses, in anthropomorphic language. However, this would only be a partial revelation of Himself, since it is impossible for human beings to comprehend Him fully.<sup>1</sup> God explained that no one can view Him directly and live (v. 20).

"As our bodily eye is dazzled, and its power of vision destroyed, by looking directly at the brightness of the sun, so would our whole nature be destroyed by an unveiled sight of the brilliancy of the glory of God."<sup>2</sup>

God did grant Moses a greater revelation of Himself, even though it was a limited revelation. This revelation helped Moses to fulfill his duty as a mediator, by giving him a greater appreciation for the Person of Yahweh (cf. 2 Cor. 12:4). This is what all the leaders of God's people need (cf. Phil. 3:8-10).

"... though Yahweh does indeed come to Moses in theophany [a visible manifestation of God], what he gives to Moses is quite specifically *not* the *sight* of this beauty, his glory, his Presence—that, indeed, he pointedly denies. What he gives rather is a *description*, and at that, a description not of how he *looks* but of how he *is*."<sup>3</sup>

"When God's servants are discouraged and disappointed because of the sins of their people, the best remedy for a broken heart is a new vision of the glory of God."<sup>4</sup>

---

<sup>1</sup>See Tozer, *The Pursuit ...*, p. 6.

<sup>2</sup>Keil and Delitzsch, 2:237.

<sup>3</sup>Durham, p. 452.

<sup>4</sup>Wiersbe, p. 247.

Here God gave another dramatic revelation of Himself similar to the one that He had formerly given at Sinai (vv. 21-23; cf. 19:9-25).

### 3. The renewal of the covenant ch. 34

Moses had obtained God's promise to renew the covenant *bond* with Israel (33:14). Now God directed him to restore the covenant *revelation*, by having the Ten Commandments re-inscribed on two new stone tablets. God both provided and wrote on the first tablets, but Moses provided and God wrote on the second set of tablets.

"As Moses had restored the covenant through his energetic intercession, he should also provide the materials for the renewal of the covenant record, and bring them to God, for Him to complete and confirm the record by writing the covenant words upon the tables."<sup>1</sup>

Again Moses stayed 40 days and 40 nights on the mountain (v. 28), but this time Joshua did not accompany him.

"Israel's initial relationship with God at Sinai, characterized by the patriarchal simplicity of the Covenant Code [Exod. 20:22—23:33], is now represented by the complex and restrictive laws of the Code of the Priests [Exod. 35—Lev. 16]."<sup>2</sup>

34:1-9 The text not only records what Moses *saw* of God's self-revelation (33:18), but it also does tells us the words that he *heard* (vv. 6-7). God introduced Himself as "the LORD, the LORD God" (v. 6). This probably means "The LORD [Yahweh], He is God" similar to "I am who I am" (cf. 3:14).<sup>3</sup> This is the only place in Scripture where God lists His own attributes. This is not a complete list of God's attributes, but only those that God revealed to Moses on this occasion: compassionate, merciful, slow to anger (patient), abounding in faithfulness (or lovingkindness) and truth, forgiving, and just. The contrast between God's blessing and His punishment is that His

---

<sup>1</sup>Keil and Delitzsch, 2:240.

<sup>2</sup>Sailhamer, *The Pentateuch ...*, p. 48.

<sup>3</sup>Cassuto, p. 439.

blessings on the righteous extend to limitless generations whereas his punishments of the wicked extend only to a few generations. An individual's conduct has repercussions on his or her descendants, for good or for ill.

"It never ceases to amaze me that the first thing God revealed about Himself to Moses was His compassion (Exod. 34:6)—not His holiness, sovereignty, or love."<sup>1</sup>

"There is nothing more terrible than the way in which sin clings to a man and dogs his footsteps. Let a man once steal, and he is never trusted again, even though he has made reparation for it. Men look at their fallen brothers through their sin; but God looks at man through the idealised [*sic*] life, with a love that imputes to him every virtue for Christ's sake."<sup>2</sup>

Moses' response to God's gracious revelation was to worship God (v. 8).<sup>3</sup>

Encouraged by this revelation, Moses prayed again and requested that God would dwell in the midst of Israel (cf. 33:15), pardon their wrongdoing and sin, and re-establish His covenant with the nation (v. 9).

34:10-26 In response, God announced that He would restore the covenant. That is, He would establish the Mosaic Covenant again (v. 10). Furthermore, He would perform new miracles never before seen, namely, when He would drive out the Canaanites (v. 11).

"The enormity of Israel's refusal to obey God's command and conquer the land (see Num. 13; 14)

---

<sup>1</sup>Laney, p. 48.

<sup>2</sup>Meyer, pp. 448-49.

<sup>3</sup>See J. Carl Laney, "God's Self-Revelation in Exodus 34:6-8," *Bibliotheca Sacra* 158:629 (January-March 2001):36-51.

is to be seen in the light of this extraordinary promise (see also Deut. 4:32-40)."<sup>1</sup>

To remind the Israelites of their duties in the covenant relationship, God repeated two of the fundamental ordinances (chs. 21—23) that would determine their attitude toward Him:

1. They were to make no covenant with the Canaanites but tear down all their pagan religious paraphernalia (vv. 12-13). The Israelites were to live by only one covenant: their covenant with Yahweh at Sinai. God is a "jealous" God in the sense that He desires that His people remain faithful to Him and worship Him exclusively, not that He is a suspicious God by nature. Jealousy is another of His attributes—part of what constitutes Him: His name (v. 14).
2. The Israelites were to worship God only as He had specified (vv. 17-26). Their failure to do this had resulted in the worship of the golden calf.

34:27-28

"The tangible token of the renewal is the handing over of two tables of the testimony like the first, which had been shattered at the time when the original covenant had been annulled. The ceremony was to be similar to the first one, but not so festive, just as the second wedding of one who marries his divorced wife is not quite the same as the first. The break has been healed, but it is not possible to undo the fact that at some time the break had existed."<sup>2</sup>

"A person can survive without food for weeks. But no one can go without water for more than three or four days. If Moses drank no water for forty

---

<sup>1</sup> *The Nelson ...*, p. 162.

<sup>2</sup> Cassuto, pp. 437-38.

days [v. 28], then we must view his continued existence as a miracle of the Lord."<sup>1</sup>

This is the only place where we read that Moses wrote on the stone tablets the words of the covenant (v. 28). Elsewhere Moses wrote that God wrote on the tablets—with His "finger" (31:18; cf. 24:12; 32:16; 34:1; Deut. 10:2, 4). Since God does not have fingers, it appears that what Moses meant was that God had a very direct involvement in the wording of the Ten Commandments. Moses apparently did the writing, on both sets of stone tablets, and God told Him exactly what to write.

34:29-35 The transformation that Moses experienced as a result of his close fellowship with God showed in his physical appearance, particularly in his face (cf. Matt. 17:1-3). This change made the other Israelites uncomfortable around him. The evidence of his close relationship with God convicted them. Evidently Moses' shining face was evidence to the Israelites that he had been in the LORD's presence, and that what he told them was an oracle from God (a prophetic word directly from God). The purpose of the veil that Moses wore over his face, while speaking with the Israelites at other times, was to hide the fact that the glory was fading (2 Cor. 3:13).

"The physical nature of this phenomenon must remain a mystery, but its theological meaning is crystal clear. Moses, as covenant mediator, was authenticated as such by his resemblance to the God of glory whom he represented. It is precisely for this reason that Moses and Elijah shared the radiance of the transfigured Jesus (Luke 9:31-32)."<sup>2</sup>

The Hebrew word translated "shone" (v. 29) is unusual, and is related to the word translated "horn," meaning "rayed." In the Latin Vulgate, Jerome translated the clause in light of the basic meaning of the root word: "horned." This led some ancient

---

<sup>1</sup> *The Nelson ...*, p. 163. On the practice of fasting, see Kent D. Berghuis, "A Biblical Perspective on Fasting," *Bibliotheca Sacra* 158:629 (January-March 2001):86-103.

<sup>2</sup> Merrill, "A Theology ...," p. 56. Cf. Durham, p. 468.

painters to represent Moses in art with horns coming out of his head.

"Henceforth, the covenant that God makes with Israel will focus on the role of the mediator. Through him God will display his glory to his people."<sup>1</sup>

The covenant, as renewed, required the separation of the Israelites from the nations that God would drive out before them. The realization of the blessings that God promised depended on the Israelites' obedience to this command.

The blessing of God's people rests on the faithful lovingkindness of God and the intercession of their leaders: Jesus Christ and human leaders. One cannot stress too much the importance of the kind of intercession that Moses modeled on this occasion. If God has given you a ministry of leadership, your intercession for those you lead, or your lack of it, will directly affect their welfare.

"In this tragic story [of the breaking and renewing of the Mosaic Covenant, in chapters 32—34] is the central message of the Bible: Despite the repeated sinfulness of His people, God is merciful. He forgives those who repent (Acts 2:38)."<sup>2</sup>

#### **E. THE CONSTRUCTION AND DEDICATION OF THE OBJECTS USED IN ISRAEL'S WORSHIP CHS. 35—40**

The renewal of the covenant made the erection of the tabernacle possible. Here begins what scholars refer to as the Code of the Priests (Exod. 35—Lev. 16). Having broken the covenant once, God proceeded to review His instructions and to give His people additional stringent requirements.

"... the Code of the Priests sought to ensure Israel's obedience through an elaborate system of priestly requirements. As the Sinai narrative [Exod. 19—Num. 10] unfolds, then, the simple 'everyman's' altar of the Covenant Code (Ex 20:24-25) gives way to the singular and more elaborate bronze altar of the

---

<sup>1</sup>Sailhamer, *The Pentateuch ...*, p. 317.

<sup>2</sup>*The Nelson ...*, p. 157.

tabernacle (Ex 27:1-8; 38:1-7), one that was to be used solely by the priests (Lev 1 ff.)."<sup>1</sup>

"The similarities of Exod 25—31 and 35—40 may all be accounted for on the basis of their rootage in this all-encompassing theme: both sections, each in its own way, are preoccupied with Israel's need to experience the reality of Yahweh's Presence."<sup>2</sup>

### 1. Preparations for construction 35:1—36:7

Following the restoration of the covenant, Moses announced God's directions for the construction of the tabernacle. In building it, the Israelites were to work only six days a week. They were to rest on the Sabbath every week, from then on, because it was a holy day (35:2-3).

"Kindling a fire receives special attention here because the people thought that kindling a fire was not a work, but only a preparation for some kind of work. But the Law makes sure that this too was not done."<sup>3</sup>

"It would be very hard to carry on our society without someone working on the Sabbath day, which is Saturday. Suppose no fire was kindled on the Sabbath. This would cause great problems in the frozen North. God's laws were made to suit the land in which Israel lived."<sup>4</sup>

Next, Moses invited the people to bring their contributions for the construction (35:4-19; cf. 25:1-9). These donations would have been the Israelites' own goods. Some were items or materials the Egyptians had given them when they left Egypt, and others were possessions they had obtained from traders they had met during their travels since leaving Egypt.

The people began to bring what the builders needed (35:20-29). Moses again recognized Bezalel and Oholiab as unusually skillful artisans, whom

---

<sup>1</sup>Sailhamer, *The Pentateuch ...*, pp. 58-59.

<sup>2</sup>Durham, p. 474.

<sup>3</sup>*The NET2 Bible* note on 35:3.

<sup>4</sup>McGee, *Thru the ...*, 1:309.



God had gifted and appointed to lead the construction work (35:30—36:2).

"Following the blueprint [36:1] is very important because the tabernacle is God's portrait of Christ."<sup>1</sup>

God's provision of Bezalel and Oholiab inspired the people to give even more ("much more than enough," 36:5), so much more that Moses had to tell the people to stop giving (36:6; cf. 2 Cor. 9:7). So the people proved their commitment to the covenant, and to Yahweh, by their generous contributions to the project that He had ordered.<sup>2</sup>

"God has an eye to the heart of the giver more than to the value of the gift [cf. Mark 12:41-44]."<sup>3</sup>

English translations render the Hebrew word *tahash* (in 35:7, 23; et al) "badger skins" (AV, NKJV), "goatskins" (ESV), "goat hair" (TNIV), "manatee skins" (HCSB), "porpoise hides" (NEB), and "hides of sea cows" (NIV). Critics have objected that aquatic animals would not have been available to the Israelites in the wilderness. Another translation is "fine leather" (NASB, NET2, NRSV, CEV), which sidesteps this problem.

"While the seal and porpoise, as well as the dolphin and dugong, are all found in the waters near Sinai, and are possible candidates for the *tahash*, most recent writers favor the dugong."<sup>4</sup>

## **2. Execution of the work 36:8—39:43**

Moses described the directions for constructing the tabernacle and its furnishings earlier (chs. 25—31). This section, which may appear redundant to the modern reader, shows that the Israelites carried out everything that God had commanded—just as He had specified to Moses. Ancient Near Eastern writers repeated information to stress its importance.<sup>5</sup> The text repeats "he made" many times, referring to Bezalel (cf. 36:14, 31, 35; et

---

<sup>1</sup>Ibid., 1:311.

<sup>2</sup>See Dwayne H. Adams, "The Building Program that Works (Exodus 25:4—36:7 [31:1-11])," *Exegesis and Exposition* 1:1 (Fall 1986):82-92.

<sup>3</sup>Henry, p. 112.

<sup>4</sup>Free, p. 107.

<sup>5</sup>See Kaiser, "Exodus," revised ed., p. 551.

al.). I will simply give a breakdown of the individual items here with references and parallel references rather than repeating comments I have made earlier (cf. also 35:11-19).

### **The tabernacle 36:8-38**

The hangings and coverings 36:8-19 (cf. 26:1-14)

"The excavations in Egypt have brought forth many bronze mirrors [v. 8}, not only showing their use in that time, but also giving us the explanation as to why the Israelite women happened to have such mirrors. They had just come out of Egypt and would have had such mirrors as part of their possessions. They may have had even more mirrors than they would have ordinarily possessed, since the Egyptians gave them many gifts at the time of the Exodus (Exod. 12:35, 36)."<sup>1</sup>

The boards and bars 36:20-34 (cf. 26:15-30)

The veil and screen 36:35-38 (cf. 26:31-37)

"The order of recounting the construction of the parts of the tabernacle is not the same as that of the instructions in Exodus 25—30. ... The purpose for this change is perhaps to begin with, and thus highlight, the part of the work that involved 'all the skilled workers' before moving on to that work which involved only Bezalel. Thus the picture given at the beginning of the narrative is that of the total participation of all the people."<sup>2</sup>

### **The furniture, vessels, and courtyard 37:1—38:20**

The ark of the covenant 37:1-9 (cf. 25:10-22)

The table of showbread 37:10-16 (cf. 25:23-30)

The lampstand 37:17-24 (cf. 25:31-40)

---

<sup>1</sup>Free, p. 108.

<sup>2</sup>Sailhamer, *The Pentateuch ...*, p. 318.

The altar of incense 37:25-28 (cf. 30:1-10)

The anointing oil and incense 37:29 (cf. 30:22-28)

The brazen altar 38:1-7 (cf. 27:1-8)

The laver 38:8 (cf. 30:17-21)

"The mirrors spoken of here were made of brass [AV, probably bronze, an alloy of copper and tin, NASB, et al.] which was highly polished. Women have not changed; they carried mirrors in that day, too. The laver was made from these mirrors. The mirror represents the Word of God. It is the Bible that shows the believer his need for cleansing. The laver was there for cleansing. We have the same thing in our bathrooms to day. We have a mirror, and beneath the mirror is a wash basin."<sup>1</sup>

The courtyard 38:9-20 (cf. 27:9-19)

### **The raw materials 38:21-31**

Moses also recorded an estimate of the amount of precious metals used (38:21-31). Coined money did not exist until the eighth century B.C., when the Lydians in Anatolia (modern Turkey) invented it.<sup>2</sup> Consequently the "shekel" Moses referred to was a measure of weight (not quite half an ounce).<sup>3</sup> The materials included slightly over a ton of gold (v. 24), almost four tons of silver (vv. 25-28), and about two and a half tons of bronze (vv. 29-31). Peter Enns computed the total to be about 15,000 pounds.<sup>4</sup>

"Verses 25-26 give an insight into the population of Israel at this time. There are three thousand shekels to a talent; therefore  $3,000 \times 100 = 300,000 + 1,775 = 301,775$ . Since each man (from twenty years and older) is valued at a half shekel, the total number of men able to bear arms is over six hundred thousand ( $301,775 \times 2 = 603,550$ )—a number

---

<sup>1</sup>McGee, *Thru the ...*, 1:315.

<sup>2</sup>*The New Bible Dictionary*, s.v. "Money," by A. F. Walls, pp. 836-41.

<sup>3</sup>*Ibid.*, s.v. "Weights and Measures," by D. J. Wiseman and D. H. Wheaton, pp. 1319-25.

<sup>4</sup>Enns, p. 549.

identical or nearly identical to the later counts of Numbers 1:46 (603,550) or 26:51 (601,730)."<sup>1</sup>

### **The priests' clothing 39:1-31**

Moses described the preparation of the priests' clothes at length, as is appropriate in view of their importance.<sup>2</sup>

The ephod 39:2-7 (cf. 28:6-12)

The breastpiece 39:8-21 (cf. 28:15-29)

The robe 39:22-26 (cf. 28:31-34)

The other accessories 39:27-31 (cf. 28:39-40, 42)

Note the repetition of the fact that the craftsmen followed the LORD's instructions to Moses precisely ("just as the LORD had commanded Moses," vv. 1, 5, 7, 21, 26, 29, 31; and "all that the LORD had commanded Moses; so they did," v. 32).

"This almost monotonous repetition of the fact that the work was carried out according to the pattern is full of significance. Everything was intended to teach the people that the one simple basis of relationship between them and God must ever be implicit obedience to the minutest detail of divine instructions."<sup>3</sup>

### **Presentation to Moses 39:32-43**

The builders and craftsmen then presented the finished tabernacle items to Moses. The fact that he listed them again in the text reflects their importance. The statement that they did their work "just as [and "according to everything"] the LORD had commanded Moses" brackets the section (vv. 32, 42). As in the Creation narrative (Gen. 1:28), a blessing concludes the tabernacle construction narrative ("So Moses blessed them," v. 43).

---

<sup>1</sup>Kaiser, "Exodus," revised ed., p. 559.

<sup>2</sup>See John E. Johnson, "The Old Testament Offices as Paradigm for Pastoral Identity," *Bibliotheca Sacra* 152:606 (April-June 1995):182-200.

<sup>3</sup>G. Campbell Morgan, *An Exposition ...*, p. 50.

"The readiness and liberality with which the people had presented the gifts required for this work, and the zeal which they had shown in executing the whole of the work in rather less than half a year (see at 40:17), were most cheering signs of the willingness of the Israelites to serve the Lord, for which they could not fail to receive the blessing of God."<sup>1</sup>

### 3. The erection and consecration of the tabernacle ch. 40

God's command Moses to erect the tabernacle (vv. 1-15). Then Moses' obeyed to this command (vv. 16-33). Seven times in this chapter we again read that Moses did "just as" the LORD had commanded him (vv. 19, 21, 23, 25, 27, 29, 32; cf. Heb. 3:5).

The Israelites erected "the tabernacle of the tent of meeting" on the first day of the first month, almost exactly one year after the Israelites left Egypt (vv. 2, 17). This was about nine months after Israel had arrived at Mt. Sinai (cf. 19:1). Here "the tent of meeting" does not refer to the smaller tent that preceded the "tabernacle," as it does in some places earlier in Exodus (especially in chapters 25 and 33), but to the "tabernacle" structure proper.

"It is no surprise ... that the tabernacle, itself a microcosm of creation, is also set up one year later on the first day of the first month. It, too, is a new creation."<sup>2</sup>

"The writer's careful attention to the chronology of the events is important, for it shows that the restriction of the offering of the Passover lamb to the central worship center (Dt 16:1-8) could thus have already been carried out during this first celebration of the Passover in the wilderness."<sup>3</sup>

When the tabernacle stood complete, God descended in "the cloud" that so filled the tabernacle that neither Moses (nor anyone else) could enter it (vv. 34-39; cf. 24:16; 25:8).

---

<sup>1</sup>Keil and Delitzsch, 2:255.

<sup>2</sup>Enns, p. 552.

<sup>3</sup>Sailhamer, *The Pentateuch ...*, pp. 321-22.

Finally God was dwelling among His people. His redemption of them was now complete. He had liberated them from bondage in Egypt (chs. 1—15), and had adopted them as His special treasure (chs. 15—40). He had made a covenant with them, and now blessed them with His presence. He would guide them from then on "throughout their journeys" (vv. 36, 38). The descent of God in the cloud, to take up residence in the midst of His people, is therefore a fitting climax of this book.

Moses, however, was not able to enter the tabernacle because of the cloud (v. 34). This indicates that more provisions were necessary before fellowship with God could continue. Leviticus explains those provisions.<sup>1</sup>

---

<sup>1</sup>See Paul F. Kiene, *The Tabernacle of God in the Wilderness*, which contains many color pictures of a model as well as explanations of the furniture, priestly garments, etc.

## Conclusion

The major message of this book is that Yahweh is the *sovereign* God who provides deliverance for people from the slavery in which they find themselves. Moses revealed God's methods of providing salvation in Exodus.

God's method of dealing with the whole *human race* was to create a pattern, in the nation of Israel, of how glorious it can be to live under the government of Yahweh. His method of dealing with *Israel* was by revealing Himself in power and great glory. God intended this revelation to produce the double reaction of *obedience* (horizontally) and *worship* (vertically) in the Israelites. God's method of dealing with *individuals* was by providing opportunities to obey and experience blessing, or to disobey and experience punishment (for unbelievers) or chastisement (for believers).

God's purposes for the human race and for the nation of Israel, as revealed in Exodus, are continually moving forward. People's actions—such as disobedience, apostasy, and rebellion—affect God's purposes, but they never frustrate them. People's actions in Exodus fail apart from God's grace. This fact demonstrates that both in his nature and in his practice, man is a congenital sinner.

God's *grace* in choosing Israel, and blessing her with deliverance, adoption, and His abiding presence, stands out clearly in Exodus, especially in view of Israel's ingratitude and rebelliousness.

"Exodus contains some of the richest, foundational theology of all the books in the OT. Preeminently, it lays the foundations for a theology of God's revelation of his person, his redemption, his law, and his worship. It also initiates the great institution of the priesthood and the role of the prophet and formalizes the covenant relationship between God and his people."<sup>1</sup>

---

<sup>1</sup>Kaiser, "Exodus," p. 292.

## Appendix 1

### The Hebrew Calendar<sup>1</sup>

Pre-exile month	Post-exile month	Sacred Year month	Civil Year month	Days of the month	Festival	Modern month	Agricultural season
Abib	Nisan	1	7	1	New Moon	Mar/Apr	Spring Equinox
				14	Passover		Occasional sirocco
				15-21	Unleavened Bread		Latter rains; flood season; beginning of barley season
				16	First-fruits		Flax Harvest
				21	Holy Convocation		
Ziv	Iyyar	2	8			Apr/May	Dry season begins; apricots ripen
	Sivan	3	9	7	Pentecost (Feast of Weeks)	May/June	Wheat harvest begins; dry winds; early figs; grapes ripen
	Tammuz	4	10			June/July	Hot, dry season;

---

<sup>1</sup>Davis, p. 142.



							grape harvest
	Ab	5	11			July/ Aug	Air still; heat intense; olive harvest
	Elul	6	12			Aug/ Sept	Dates and summer figs
Ethanim	Tishri	7	1	1	Blowing of Trumpets	Sept/ Oct	Early (former) rains
				10	Day of Atonement		Heavy dews
				15-21	Feast of Tabernacles		Plowing; seed time
				22	Solemn Assembly		
Bul	Heshvan	8	2			Oct/Nov	Rains; winter figs; wheat and barley sown
	Chislev	9	3	25	Dedication	Nov/Dec	Winter begins; pastures become green
	Tebeth	10	4			Dec/Jan	Coldest month; rains; snow on high ground
	Shebat	11	5			Jan/Feb	Growing warm;

							almond trees blossom
	Adar	12	6	15	Feast of Purim	Feb/Mar	Spring (latter) rains begin; citrus fruit harvest

# Appendix 2

## Moses' Trips Up Mt. Sinai

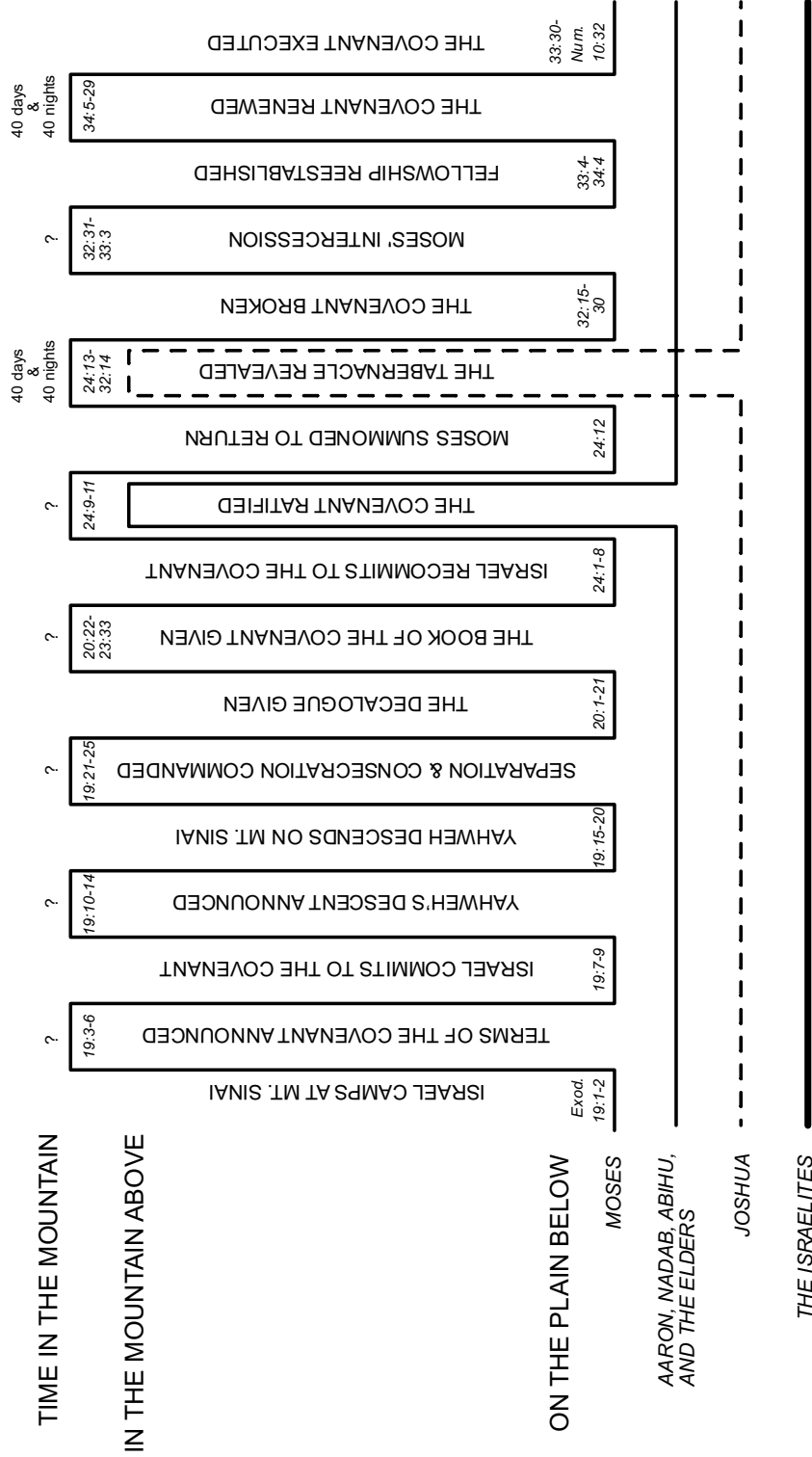

## Bibliography

Adams, Dwayne H. "The Building Program that Works (Exodus 25:4--36:7 [31:1-11])." *Exegesis and Exposition* 1:1 (Fall 1986):82-92.

Aharoni, Yohanan. "Kadesh-Barnea and Mount Sinai." In *God's Wilderness: Discoveries in Sinai*, pp. 115-70. Edited by B. Rothenberg, Y. Aharoni, and A Hashimshoni. New York: Thomas Nelson & Sons, 1962.

Aharoni, Yohanan, and Michael Avi-Yonah. *The Macmillan Bible Atlas*. Revised ed. New York: Macmillan Publishing Co., 1977.

Albright, William Foxwell. *Archaeology and the Religion of Israel*. Fifth ed. Baltimore: Johns Hopkins Press, 1968.

\_\_\_\_\_. *The Archaeology of Palestine*. 1949. Revised ed. Pelican Archaeology series. Harmondsworth, Middlesex, England: Penguin Books, 1956.

\_\_\_\_\_. "Northwest-Semitic Names in a List of Egyptian Slaves from the Eighteenth Century B.C." *Journal of the American Oriental Society* 74 (1954):222-33.

Aldrich, Roy L. "The Mosaic Ten Commandments Compared to Their Restatements in the New Testament." *Bibliotheca Sacra* 118:471 (July-September 1961):251-58.

Alexander, John F. "Sabbath Rest." *The Other Side* 146 (November 1983):8-9.

Aling, Charles F. "The Biblical City of Ramses." *Journal of the Evangelical Theological Society* 25:2 (June 1982):129-37.

Allen, Ronald B. "The 'Bloody Bridegroom' in Exodus 4:24-26." *Bibliotheca Sacra* 153:611 (July-September 1996):259-69.

\_\_\_\_\_. "The Pillar of the Cloud." *Bibliotheca Sacra* 153:612 (October-December 1996):387-95.

\_\_\_\_\_. *The Wonder of Worship: A New Understanding of the Worship Experience*. Swindoll Leadership Library series. Nashville: Word Publishing, 2001.

Allis, Oswald T. *The Five Books of Moses*. 2nd ed. Philadelphia: Presbyterian and Reformed Publishing Co., 1949.

\_\_\_\_\_. *Prophecy and the Church*. Philadelphia: Presbyterian and Reformed Publishing Co., 1945.

Anati, Emmanuel. "Has Mt. Sinai Been Found?" *Biblical Archaeology Review* 11:4 (July-August 1985):42-57.

Anderson, J. Kirby. *Moral Dilemmas: Biblical Perspectives on Contemporary Ethical Issues*. Swindoll Leadership Library series. Nashville: Word Publishing, 1998.

Archer, Gleason L., Jr. *Encyclopedia of Bible Difficulties*. Grand Rapids: Zondervan Publishing House, 1982.

\_\_\_\_\_. "Old Testament History and Recent Archaeology from Abraham to Moses." *Bibliotheca Sacra* 127:505 (January-March 1970):3-25.

\_\_\_\_\_. "Old Testament History and Recent Archaeology from Moses to David." *Bibliotheca Sacra* 127:506 (April-June 1970):99-115.

\_\_\_\_\_. *A Survey of Old Testament Introduction*. Revised ed. Chicago: Moody Press, 1964, 1974.

Bacchiocchi, Samuele. "Sabbatical Typologies of Messianic Redemption." *Journal for the Study of Judaism* 17:2 (December 1986):153-76.

Baldwin, Joyce G. "The Role of the Ten Commandments." *Vox Evangelica* 13 (1983):7-18.

Barlow, Robert Andres. "The Passover Seder." *Exegesis and Exposition* 3:1 (Fall 1988):63-68.

Batto, Bernard F. "Red Sea or Reed Sea?" *Biblical Archaeology Review* 10:4 (July-August 1984):57-63.

Baxter, J. Sidlow. *Explore the Book*. 1960. One vol. ed. Grand Rapids: Zondervan Publishing House, 1980.

Beale, G. K. "An Exegetical and Theological Consideration of the Hardening of Pharaoh's Heart in Exodus 4-14 and Romans 9." *Trinity Journal* 5NS:2 (Autumn 1984):129-54.

Beit-Arieh, Itzhaq. "Fifteen Years in Sinai." *Biblical Archaeology Review* 10:4 (July-August 1984):28-54.

Beitzel, Barry J. *The Moody Atlas of Bible Lands*. Chicago: Moody Press, 1985.

Berghuis, Kent D. "A Biblical Perspective on Fasting." *Bibliotheca Sacra* 158:629 (January-March 2001):86-103.

Bimson, John J. "Redating the Exodus." *Biblical Archaeology Review* 13:5 (September-October 1986):40-53, 66-68.

\_\_\_\_\_. *Redating the Exodus and the Conquest*. JSOT supplement series. Sheffield: University of Sheffield Press, 1978.

Blaiklock, E. M. *Today's Handbook of Bible Characters*. Minneapolis: Bethany House Publishers, 1979.

Blosser, Oliver R. "Did the Pharaoh of the Exodus Drown in the Red Sea?" *It's About Time* (July 1987), pp. 8-12.

\_\_\_\_\_. "The Impact of the Ten Plagues and Mosaic Monotheism on the Religion of Akenaton: Part I." *It's About Time* (July 1987), pp. 3-7.

Bodenheimer, F. S. "The Manna of Sinai." *Biblical Archaeologist* 10:1 (February 1947):2-6.

Bonar, Andrew A. *A Commentary on Leviticus*. 5th ed. Geneva Series Commentary series. London: Banner of Truth Trust; reprint ed., 1966.

Booij, Thijs. "Mountain and Theophany in the Sinai Narrative." *Biblica* 65:1 (1984):1-26.

Bramer, Stephen J. "Suffering in the Pentateuch." In *Why, O God? Suffering and Disability in the Bible and the Church*, pp. 87-97. Edited by Larry J. Waters and Roy B. Zuck. Wheaton: Crossway, 2011.

Brichto, Herbert Chanan. "The Worship of the Golden Calf: A Literary Analysis of a Fable on Idolatry." *Hebrew Union College Annual* 54 (1983):1-44.

Bright, John. *A History of Israel*. Philadelphia: Westminster Press, 1959.

- Budge, E. A. W. *The Gods of the Egyptians*. New York: Dover Press, 1969.
- Bunn, John T. "The Ark of the Covenant." *Biblical Illustrator* 9:4 (Summer 1983):50-53.
- Burden, Jasper J. "A Stylistic Analysis of Exodus 15:1-21: Theory and Practice." *OTWSA* 29 (1986):34-70.
- Bury, J. B.; S. A. Cools; and F. E. Adcock, eds. *The Cambridge Ancient History*. 12 vols. 2nd ed. Reprinted. Cambridge: University Press, 1928.
- Bush, George. *Notes on Exodus*. 2 vols. Reprint ed. Minneapolis: James and Klock, 1976.
- Calvin, John. *Institutes of the Christian Religion*. The Library of Christian Classics series, volumes 20 and 21. Edited by John T. McNeill. Translated by Ford Lewis Battles. Philadelphia: Westminster Press, 1960.
- Cassuto, Umberto. *A Commentary on the Book of Exodus*. Translated by Israel Abrahams. Reprinted. English ed. Jerusalem: Magnes Press, 1983.
- Chafer, Lewis Sperry. *Grace*. 2<sup>nd</sup> ed. Grand Rapids: Kregel Publications, 1922, 1995.
- Childs, Brevard S. *The Book of Exodus*. The Old Testament Library series. Philadelphia: Westminster Press, 1974.
- Chirichigno, G. C. "The Narrative Structure of Exod 19-24." *Biblia* 68:4 (1987):457-79.
- Chisholm, Robert B., Jr. "Divine Hardening in the Old Testament." *Bibliotheca Sacra* 153:612 (October-December 1996):410-34.
- \_\_\_\_\_. "Does God 'Change His Mind'?" *Bibliotheca Sacra* 152:608 (October-December 1995):387-99.
- \_\_\_\_\_. "The Polemic against Baalism in Israel's Early History and Literature." *Bibliotheca Sacra* 151:603 (July-September 1994):267-83.

- Chismar, Douglas E. and David A Raush. "Regarding Theonomy: An Essay of Concern." *Journal of the Evangelical Theological Society* 27:3 (September 1984):315-23.
- Clapham, Phillip. "In Search of the Exodus." *Catastrophism and Ancient History* 8:2 (July 1986):97-133.
- Clapp, Rodney. "Democracy as Heresy." *Christianity Today* 31:3 (February 20, 1987):17-23.
- Cole, R. Alan. *Exodus: An Introduction and Commentary*. Tyndale Old Testament Commentary series. Downers Grove: InterVarsity Press, 1973.
- Congdon, Robert N. "Exodus 21:22-25 and the Abortion Debate." *Bibliotheca Sacra* 146:582 (April-June 1989):132-47.
- Constable, Thomas L. "What Prayer Will and Will Not Change." In *Essays in Honor of J. Dwight Pentecost*. Edited by Stanley D. Toussaint and Charles H. Dyer. Chicago: Moody Press, 1986.
- Cox, Dorian G. Coover. "The Hardening of Pharaoh's Heart in Its Literary and Cultural Contexts." *Bibliotheca Sacra* 163:651 (July-September 2006):292-311.
- Craigie, Peter C. *The Problem of War in the Old Testament*. Grand Rapids: Wm. B. Eerdmans Publishing Co., 1978.
- \_\_\_\_\_. *Ugarit and the Old Testament*. Grand Rapids: Wm. B. Eerdmans Publishing Co., 1983.
- Cross, Frank Moore, Jr. "The Song of the Sea and Canaanite Myth." In *God and Christ: Existence and Province*, pp. 1-25. Edited by Robert W. Funk. New York: Harper and Row, 1968.
- \_\_\_\_\_. "The Tabernacle." *Biblical Archaeologist* 10:3 (September 1947):45-68.
- Curtis, Edward M. "The Theological Basis for the Prohibition of Images in the Old Testament." *Journal of the Evangelical Theological Society* 28:3 (September 1985):277-87.



- Dalman, Rodger. "Egypt and Early Israel's Cultural Setting: A Quest for Evidential Possibilities." *Journal of the Evangelical Theological Society* 51:3 (September 2008):449-88.
- Darby, John Nelson. *Synopsis of the Books of the Bible*. Revised ed. 5 vols. New York: Loizeaux Brothers Publishers, 1942.
- Davis, John J. *Moses and the Gods of Egypt*. Grand Rapids: Baker Book House, 1971.
- Deere, Jack S. "Deuteronomy." In *The Bible Knowledge Commentary: Old Testament*, pp. 259-324. Edited by John F. Walvoord and Roy B. Zuck. Wheaton: Scripture Press Publications, Victor Books, 1985.
- DeHaan, Martin Ralph. *The Chemistry of the Blood and Other Stirring Messages*. 2nd ed. Grand Rapids: Zondervan Publishing House, 1943.
- Deist, F. E. "Who is to blame: the Pharaoh, Yahweh or circumstance? On human responsibility, and divine ordinance in Exodus 1—14." *OTWSA* 29(1986):91-110.
- DeMar, Gary. *The Debate over Christian Reconstruction*. Ft. Worth: Dominion Press; and Atlanta: American Vision Press, 1988.
- Dennett, Edward. *Typical Teachings of Genesis*. London: G. Morrish, n.d.
- Dennison, James T., Jr. "The Exodus: Historical Narrative, Prophetic Hope, Gospel Fulfillment." *Covenant Seminary Review* 8:2 (Fall 1982):1-12.
- Dillow, Joseph C. *The Reign of the Servant Kings*. Miami Springs, Fl.: Schoettle Publishing Co., 1992.
- Dumbrell, William J. *Covenant and Creation: A Theology of Old Testament Covenants*. Nashville: Thomas Nelson Publishers, 1984.
- Dunnam, Maxie D. *Exodus*. The Communicator's Commentary series. Waco: Word Books, 1987.
- Dunnett, Dolores E. "Evangelicals and Abortion." *Journal of the Evangelical Theological Society* 33:2 (June 1990):215-25.
- Durham, John I. *Exodus*. Word Biblical Commentary series. Waco: Word Books, 1987.

- Dyer, Charles H. "The Date of the Exodus Reexamined." *Bibliotheca Sacra* 140:559 (July-September 1983):225-43.
- Dyer, Charles H., and Gregory A. Hatteberg. *The New Christian Traveler's Guide to the Holy Land*. Chicago: Moody Publishers, 2006.
- Dyer, Charles H., and Eugene H. Merrill. *The Old Testament Explorer*. Nashville: Word Publishing, 2001. Reissued as *Nelson's Old Testament Survey*. Nashville: Thomas Nelson Publishers, 2001.
- Edersheim, Alfred. *The Temple: Its Ministry and Services As They Were at the Time of Jesus Christ*. Reprint ed. Grand Rapids: Wm. B. Eerdmans Publishing Co., 1972.
- Eichrodt, Walther. *Theology of the Old Testament*. 5<sup>th</sup> ed. revised. 2 vols. Translated by John A. Baker. The Old Testament Library series. Philadelphia: Westminster Press, 1961 and 1967.
- Ellison, H. L. *Exodus*. Daily Study Bible series. Philadelphia: Westminster Press, 1982.
- Encyclopaedia Judaica*. S.v. "Cuneiform Law," by J. Finkelstein, 16:1505i.
- Enns, Peter. *Exodus*. The NIV Application Commentary series. Grand Rapids: Zondervan, 2000.
- Exum, J. Cheryl. "'You Shall Let Every Daughter Live': A Study of Exodus 1:8—2:10." *Semeia* 28 (1983):63-82.
- Fass, David E. "The Molten Calf: Judgment, Motive, and Meaning." *Judaism* 39:2 (Spring 1990):171-83.
- Fawver, Jay D., and R. Larry Overstreet. "Moses and Preventive Medicine." *Bibliotheca Sacra* 147:587 (July-September):270-85.
- Fensham, F. C. "Extra-Biblical Material and the Hermeneutics of the Old Testament with Special Reference to the Legal Material of the Covenant Code." *OTWSA* 20 & 21 (1977 & 78):53-65.
- Finegan, Jack. *Let My People Go*. New York: Harper & Row Publishers, 1963.

- \_\_\_\_\_. *Light from the Ancient Past: The Archeological Background of Judaism and Christianity*. 2<sup>nd</sup> edition. Princeton University Press. London: Oxford University Press, 1959.
- Finkelstein, Israel. "Raider of the Lost Mountain—An Israeli Archaeologist Looks at the Most Recent Attempt to Locate Mt. Sinai." *Biblical Archaeology Review* 15:4 (July-August 1988):46-50.
- Frankfort, Henri. *Ancient Egyptian Religion*. New York: Columbia University Press, 1948; reprint ed., New York: Harper and Row; Harper Torchbooks, 1961.
- Franz, Gordon. "Mt. Sinai Is Not Jebel El-Lawz in Saudi Arabia." A paper presented at the Annual Meeting of the Evangelical Theological Society, 15 November 2001, Colorado Springs, Colo.
- Free, Joseph P. *Archaeology and Bible History*. 6th ed. Wheaton: Scripture Press, 1950, 1959.
- Fretheim, Terence E. *Exodus*. Interpretation series. Louisville: John Knox, 1991.
- Fruchtenbaum, Arnold G. "Israel and the Church." In *Issues in Dispensationalism*, pp. 113-30. Edited by Wesley R. Willis and John R. Master. Chicago: Moody Press, 1994.
- \_\_\_\_\_. "The Sabbath Controversy." *Biblical Research Monthly* 49:4 (July-August 1984):14-16.
- Gaebelein, Arno C. *The Annotated Bible*. 4 vols. Reprint ed. Chicago: Moody Press, and New York: Loizeaux Brothers, 1970.
- Gardner, Joseph L., ed. *Reader's Digest Atlas of the Bible*. Pleasantville, N.Y.: Reader's Digest Association, 1985.
- Gentry, Peter J. "The Meaning of 'Holy' in the Old Testament." *Bibliotheca Sacra* 170:680 (October-December 2013):400-17.
- Gevirtz, Stanley. "Heret, in the Manufacture of the Golden Calf." *Biblica* 65 (1984):377-81.
- Gianotti, Charles R. "The Meaning of the Divine Name YHWH." *Bibliotheca Sacra* 142:565 (January-March 1985):38-51.

- Gispen, William H. *Exodus*. Translated by Ed van der Maas. Bible Student's Commentary series. Grand Rapids: Zondervan Publishing House, 1982.
- Gnuse, Robert. "Jubilee Legislation in Leviticus: Israel's Vision of Social Reform." *Biblical Theology Bulletin* 15:2 (April 1985):43-48.
- Goldberg, Michael. "Expository Articles: Exodus 1:13-14." *Interpretation* 37:4 (October 1983):389-91.
- Gottwald, Norman. *A Light to the Nations*. New York: Harper & Bros., 1959.
- Gray, John. *Joshua, Judges and Ruth*. New Century Bible Commentary series. London: Thomas Nelson and Sons, 1967.
- Gunn, David M. "The 'Hardening of Pharaoh's Heart': Plot, Character and Theology in Exodus 1-14." In *Art and Meaning: Rhetoric in Biblical Literature*, pp. 72-96. Edited by David J. A. Clines, David M. Gunn, and Alan J. Hauser. Journal for the Study of the Old Testament Supplement Series, vol. 19. Sheffield: University of Sheffield, 1982.
- Gurney, O. R. *The Hittites*. Baltimore: Penguin Books, 1964.
- Habel, N. "The Form and Significance of the Call Narratives." *Zeitschrift für die Alttestamentliche Wissenschaft* 77 (1965):316-23.
- Hagin, Kenneth E. *Redeemed from Poverty, Sickness, and Death*. Tulsa: Faith Library Publications, 1983.
- Hanna, Kenneth G. *From Moses to Malachi: Exploring the Old Testament*. 2nd ed. Edited by Roy B. Zuck. Bloomington, Ind.: CrossBooks, 2014.
- Hannah, John D. "Exodus." In *The Bible Knowledge Commentary: Old Testament*, pp. 103-62. Edited by John F. Walvoord and Roy B. Zuck. Wheaton: Scripture Press Publications, Victor Books, 1985.
- Harrison, R. K. *Introduction to the Old Testament*. Grand Rapids: Wm. B. Eerdmans Publishing Co., 1969, 1974.
- Hasel, Gerhard F. "The Sabbath in the Pentateuch." In *The Sabbath in Scripture and History*, pp. 21-43. Edited by Kenneth A. Strand. Washington: Review and Herald Publishing Association, 1982.

- Hawkins, Ralph K. "The Date of the Exodus-Conquest Is Still an Open Question: A Response to Rodger Young and Bryant Wood." *Journal of the Evangelical Theological Society* 51:2 (June 2008):245-66.
- Hays, J. Daniel "An Evangelical Approach to Old Testament Narrative Criticism." *Bibliotheca Sacra* 166:661 (January-March 2009):3-18.
- Hengstenberg, Ernst W. *Egypt and the Books of Moses*. Translated by R. D. C. Robbins. New York: M. H. Newman, 1843.
- Henry, Matthew. *Commentary on the Whole Bible*. One volume ed. Edited by Leslie F. Church. Grand Rapids: Zondervan Publishing Co., 1961.
- Herodotus. *The Histories*. The Landmark Herodotus edition. Edited by Robert B. Strassler. Translated by Andrea L. Purvis. Pantheon Books, Random House: New York and Toronto, 2007.
- Hiebert, D. Edmond. *Working with God: Scriptural Studies in Intercession*. New York: Carlton Press, Hearthstone Book, 1987.
- Hilber, John W. "Theology of Worship in Exodus 24." *Journal of the Evangelical Theological Society* 39:2 (June 1996):177-89.
- Hindson, Edward E. *The Philistines and the Old Testament*. Baker Studies in Biblical Archaeology series. Grand Rapids: Baker Book House, 1983.
- Hodge, Charles. *Systematic Theology*. 3 vols. New York: Charles Scribner's Sons, 1887.
- Hoehner, Harold W. "The Duration of the Egyptian Bondage." *Bibliotheca Sacra* 126:504 (October-December 1969):306-16.
- Hoffmeier, James K. "What Is the Biblical Date for the Exodus? A Response to Bryant Wood." *Journal of the Evangelical Theological Society* 50:2 (June 2007):225-47.
- Holmgren, Fredrick. "Before the Temple, the Thornbush: An Exposition of Exodus 2:11—3:12." *Reformed Journal* 33:3 (March 1983):9-11.
- The Holy Bible: Authorized King James Version*. Cambridge, U.K.: Cambridge University Press, n.d.

*The Holy Bible: Contemporary English Version.* New York: American Bible Society, 1995.

*The Holy Bible: English Standard Version.* Wheaton: Good News Publishers, 2001.

*The Holy Bible: Holman Christian Standard Bible.* Nashville: Holman Bible Publishers, 2004.

*The Holy Bible: New International Version.* Colorado Springs, et al.: International Bible Society, 1984.

*The Holy Bible: New King James Version.* Nashville: Thomas Nelson Publishers, 1982.

*The Holy Bible: New Revised Standard Version.* Nashville: Thomas Nelson Publishers, 1989.

*The Holy Bible: Today's New International Version.* Colorado Springs: Zondervan/International Bible Society, 2005.

Hopkins, Ezekiel. "Understanding the Ten Commandments." In *Classical Evangelical Essays in Old Testament Interpretation*, pp. 41-58. Edited by Walter C. Kaiser, Jr. Grand Rapids: Baker Book House, 1972.

Hoppe, Leslie J. "Elders and Deuteronomy." *Eglise et Theologie* 14 (1983):259-72.

Horn, Siegfried H. *Biblical Archaeology: A Generation of Discovery.* Washington: Biblical Archaeology Society, 1985.

Hort, Greta. "The Plagues of Egypt." *Zeitschrift für die Alttestamentliche Wissenschaft* 69 (1957):84-103; 70 (1958):48-59.

Houtman, Cornelis. *Exodus.* 3 vols. Translated by J. Rebel and S. Woudstra. Kampen, Netherlands: Kok, 1993-1999.

\_\_\_\_\_. "A Note on the LXX Version of Exodus 4,6." *Zeitschrift für die Alttestamentliche Wissenschaft* 97:2 (1983):253-54.

\_\_\_\_\_. "On the Meaning of Uba'esim Uba'abanim in Exodus VII 19." *Vetus Testamentum* 36:3 (1986):347-52.

- Hughes, R. Kent. *Living on the Cutting Edge*. Westchester, Il.: Good News Publishers, Crossway Books, 1987.
- Hyatt, J. Philip. *Exodus*. New Century Bible Commentary series. London: Marshall, Morgan and Scott, 1971; reprint ed., Grand Rapids: William B. Eerdmans Publishing Co., 1983.
- Ironside, Harry A. *The Continual Burnt Offering: Daily Meditations on the Word of God*. 2<sup>nd</sup> ed. New York: Loizeaux Brothers, Bible Truth Depot, 1943.
- Isser, Stanley. "Two Traditions: The Law of Exodus 21:22-23 Revisited." *Catholic Biblical Quarterly* 52:1 (January 1990):30-45.
- Jamieson, Robert; A. R. Fausset; and David Brown. *Commentary Practical and Explanatory on the Whole Bible*. Reprint ed. Grand Rapids: Zondervan Publishing House, 1961.
- Jacob, Benno. *The Second Book of the Bible: Exodus*. Hoboken: KTAV, 1992.
- Jacob, Edmond. *Theology of the Old Testament*. Translated by Arthur W. Heathcote and Philip J. Allcock. New York and Evanston, Ill.: Harper & Row, 1958.
- Jennings, J. E. "Ancient Near Eastern Religion and Biblical Interpretation." In *Interpreting the Word of God*, pp. 11-30. Edited by Samuel J. Schultz and Morris A. Inch. Chicago: Moody Press, 1976.
- Johnson, John E. "The Old Testament Offices as Paradigm for Pastoral Identity." *Bibliotheca Sacra* 152:606 (April-June 1995):182-200.
- Johnson, Philip C. "Exodus." In *The Wycliffe Bible Commentary*, pp. 51-86. Edited by Charles F. Pfeiffer and Everett F. Harrison. Chicago: Moody Press, 1962.
- Johnston, Gordon H. "I Will Multiply Your Seed." *Exegesis and Exposition* 1:1 (Fall 1986):19-32.
- Josephus, Flavius. *The Works of Flavius Josephus*. Translated by William Whiston. London: T. Nelson and Sons, 1866; reprint ed. Peabody, Mass.: Hendrickson Publishers, 1988.

- Kaiser, Walter C., Jr. "Exodus." In *Genesis-Leviticus*. Vol. 1 of *The Expositor's Bible Commentary*. Revised ed. 13 vols. Edited by Tremper Longman III and David E. Garland. Grand Rapids: Zondervan, 2008.
- \_\_\_\_\_. "Exodus." In *Genesis—Numbers*. Vol. 2 of *The Expositor's Bible Commentary*. 12 vols. Edited by Frank E. Gaebelin and Richard P. Polcyn. Grand Rapids: Zondervan Publishing House, 1990.
- \_\_\_\_\_. *Toward an Old Testament Theology*. Grand Rapids: Zondervan Publishing House, 1978.
- \_\_\_\_\_. *Toward Old Testament Ethics*. Grand Rapids: Zondervan Publishing House, 1983.
- Kalland, Lloyd. "Fetal Life." *Eternity*, February 1971, pp. 18-21, 24.
- Keil, C. F., and Franz Delitzsch. *The Pentateuch*. 3 vols. Translated by James Martin. Biblical Commentary on the Old Testament. N.p.; reprint ed., Grand Rapids: Wm. B. Eerdmans Publishing Co., n.d.
- Keller, Timothy. *Counterfeit Gods: The Empty Promises of Money, Sex, and Power, and the Only Hope that Matters*. New York: Penguin Random House, 2009.
- Kempinski, Aharon. "Jacob in History." *Biblical Archaeology Review* 14:1 (January-February 1988):42-47.
- Kennedy, James M. "The Social Background of Early Israel's Rejection of Cultic Images: A Proposal." *Biblical Theology Bulletin* 17:4 (October 1987);138-44.
- Kenyon, Kathleen M. *The Bible and Recent Archaeology*. Atlanta: John Knox Press, 1978.
- Kiene, Paul F. *The Tabernacle of God in the Wilderness*. Translated by John S. Crandall. Grand Rapids: Zondervan Publishing House, 1977.
- King, Geoffrey R. "Where Is the Ark of the Covenant?" *Prophetic Witness* 8:2 (February 1984):9-10.
- Kitchen, Kenneth A. *Ancient Orient and Old Testament*. Downers Grove: InterVarsity Press, 1966.



- \_\_\_\_\_. *The Bible In Its World*. Downers Grove: InterVarsity Press, 1977.
- \_\_\_\_\_. "Labour Conditions in the Egypt of the Exodus." *Buried History* 20:3 (September 1984):43-49.
- \_\_\_\_\_. "The Old Testament in its Context: 2 From Egypt to the Jordan." *Theological Students' Fellowship Bulletin* 60 (1971):3-11.
- Kline, Meredith G. "Comments on an Old-New Error." *Westminster Theological Journal* 41:1 (Fall 1978):172-89.
- \_\_\_\_\_. "Deuteronomy." In *The Wycliffe Bible Commentary*, pp. 155-204. Edited by Charles F. Pfeiffer and Everett F. Harrison. Chicago: Moody Press, 1962.
- \_\_\_\_\_. "The Feast of Cover-over." *Journal of the Evangelical Theological Society* 37:4 (December 1994):497-510.
- \_\_\_\_\_. "*Lex Talionis* and the Human Fetus." *Simon Greenleaf Law Review* 5 (1985-86):75-89.
- \_\_\_\_\_. *The Treaty of the Great King*. Grand Rapids: Wm. B. Eerdmans Publishing Co., 1963.
- Klingbeil, Gerald A., ed. *The Genesis Creation Account and Its Reverberations in the Old Testament*. Berrien Springs, Mich.: Andrews University Press, 2015.
- Koch, Kurt E. *Between Christ and Satan*. Translated by Yolanda N. Entz. Berghausen Bd., Germany: Evangelization Publishers, 1961.
- Kubo, Sakae. "Why then the law?" *Ministry* (March 1980), pp. 12-14.
- Labuschagne, C. J. *The Incomparability of Yahweh in the Old Testament*. Leiden: Brill, 1966.
- Laney, J. Carl. *God*. The Swindoll Leadership Library series. Nashville: Word Publishing, 1999.
- \_\_\_\_\_. "God's Self-Revelation in Exodus 34:6-8." *Bibliotheca Sacra* 158:629 (January-March 2001):36-51.

- Lange, John Peter, ed. *Lange's Commentary on the Holy Scriptures*. 12 vols. Reprint ed., Grand Rapids: Zondervan Publishing House, 1960. Vol. 1: *Genesis-Leviticus*, by John Peter Lange and Frederic Gardiner. Translated by Tayler Lewis, A. Gosman, and Charles M. Mead.
- Lev, Mordecai J., ed. *Sepher Mitzvoth*. Jerusalem: Mossad Harav Kook, 1990.
- Lewis, C. S. *Mere Christianity*. New York: Macmillan, 1958.
- Lightner, Robert P. "Theological Perspectives on Theonomy." *Bibliotheca Sacra* 143:569 (January-March 1986):26-36; 570 (April-June 1986):134-45; 571 (July-September 1986):228-45.
- Livingston, G. Herbert. "A Case Study of the Call of Moses." *Asbury Theological Journal* 42:2 (Fall 1987):89-113.
- \_\_\_\_\_. *The Pentateuch in Its Cultural Environment*. Grand Rapids: Baker Book House, 1974.
- Loewenstamm, Samuel E. "The Making and Destruction of the Golden Calf." *Biblica* 48 (1967):481-90.
- \_\_\_\_\_. "The Making and Destruction of the Golden Calf—a Rejoinder." *Biblica* 56 (1975):330-43.
- Longman, Tremper, III and Raymond B. Dillard. *An Introduction to the Old Testament*. 2<sup>nd</sup> ed. Grand Rapids: Zondervan, 2006.
- Lubarsky, Sandra B. "Judaism and the Justification of Abortion for Non-Medical Reasons." *Journal of Reform Judaism* 31:4 (Fall 1984):1-13.
- Macaulay, J. C. *The Bible and the Roman Church*. The Moody Colportage Library series. Chicago: Moody Press, 1946.
- M[ackintosh], C. H. *Notes on the Book of Exodus*. American ed. New York: Loizeaux Brothers, 1879.
- MacLurg, Jeffrey E. "An Ode to Joy: The Song of the Sea (Exodus 15:1-21)." *Exegesis and Exposition* 1:1 (Fall 1986):43-54.
- Magonet, Jonathan. "The Rhetoric of God: Exodus 6.2-8." *Journal for the Study of the Old Testament* 27 (1983):56-67.

- Marcus, David. "Juvenile Delinquency in the Bible and the Ancient Near East." *Journal of the Ancient Near Eastern Society of Columbia University* 13 (1981):31-52.
- Master, Jonathan. "Exodus 32 as an Argument for Traditional Theism." *Journal of the Evangelical Theological Society* 45:4 (December 2002):585-98.
- Mazar, Amihai. "Bronze Bull Found in Israelite 'High Place' from the Time of the Judges." *Biblical Archaeology Review* 9:5 (September-October 1983):34-40.
- McClain, Alva J. *The Greatness of the Kingdom, An Inductive Study of the Kingdom of God*. Winona Lake, Ind.: BMH Books, 1959; Chicago: Moody Press, 1968.
- McDermott, Gerald R. "Typology in Creation." *Bibliotheca Sacra* 175:697 (January-March 2018):5-16.
- McGee, J. Vernon. *The Tabernacle: God's Portrait of Christ*. Fourth ed. Reprint from *Bibliotheca Sacra*. N.c.: N.p, n.d.
- \_\_\_\_\_. *Thru the Bible with J. Vernon McGee*. 5 vols. Pasadena, Calif.: Thru The Bible Radio; and Nashville: Thomas Nelson, Inc., 1983.
- Mendenhall, George E. *Law and Covenant in Israel and the Ancient Near East*. Pittsburgh: Presbyterian Board of Colportage of Western Pennsylvania, 1955.
- Merrill, Eugene H. *Deuteronomy*. New American Commentary series. N.c.: Broadman & Holman Publishers, 1994.
- \_\_\_\_\_. *Kingdom of Priests*. Grand Rapids: Baker Book House, 1987.
- \_\_\_\_\_. "The Mosaic Covenant: A Proposal for Its Theological Significance." *Exegesis and Exposition* 3:1 (Fall 1988):25-33.
- \_\_\_\_\_. "A Theology of the Pentateuch." In *A Biblical Theology of the Old Testament*, pp. 7-87. Edited by Roy B. Zuck. Chicago: Moody Press, 1991.
- Meyer, Frederick Brotherton. *Devotional Commentary on Exodus*. London: Purnell, n.d.; reprint ed., Grand Rapids: Kregel Publications, 1981.

- \_\_\_\_\_. *Moses: God's Servant*. A "One Evening" Condensed Book series. Westchester, Ill.: Good New Publishers, 1961.
- Milgrom, Jacob. *Leviticus 1—16*. Anchor Bible series. New York: Doubleday, 1991.
- \_\_\_\_\_. "Thou Shalt Not Boil a Kid in It's Mother's Milk." *Bible Review* 1:3 (Fall 1985):48-55.
- Mills, Watson E. "Childbearing in Ancient Times." *Biblical Illustrator* 13:1 (Fall 1986):54-56.
- Minter, Steve. "Ten Timeless Words (Exodus 20:1-17)." *Exegesis and Exposition* 1:1 (Fall 1986):67-80.
- Mitchell, Bill. "Leviticus 24.6: The Bread of the Presence—Rows or Piles?" *Bible Translator* 33:4 (October 1982):447-48.
- Mitchell, T. C. "The Meaning of the Noun HTN in the Old Testament." *Vetus Testamentum* 19 (1969):93-112.
- Montet, Pierre. *Eternal Egypt*. Translated by Doreen Weightman. New York: New American Library, 1964.
- Morgan, G. Campbell. *An Exposition of the Whole Bible*. Westwood, N.J.: Fleming H. Revell Co., 1959.
- \_\_\_\_\_. *Living Messages of the Books of the Bible*. 2 vols. New York: Fleming H. Revell Co., 1912.
- \_\_\_\_\_. *The Ten Commandments*. New York: Fleming H. Revell Co., 1901.
- \_\_\_\_\_. *The Unfolding Message of the Bible*. Westwood, N.J.: Fleming H. Revell Co., 1961.
- Morgan, J. P. "The Morality of Suicide: Issues and Options." *Bibliotheca Sacra* 148:590 (April-June 1991):214-30.
- Mowinckel, Sigmund. "The Name of the God of Moses." *Hebrew Union College Annual* 32 (1961):121-33.
- Mowvley, Henry. "John 1:14-18 in the Light of Exodus 33:7—34:35." *Expository Times* 95:5 (February 1984):135-37.

Munro, John "Prayer to a Sovereign God." *Interest* 56:2 (February 1990):20-21.

Myers, John V. "What Was Brimstone?" *Kronos* 9:1 (Fall 1983):57-60.

Naville, Edouard. *The Store-City of Pithom and the Route of the Exodus*. London: Egypt Exploration Fund, 1885.

*The Nelson Study Bible*. Edited by Earl D. Radmacher. Nashville: Thomas Nelson Publishers, 1997.

*The NET2 (New English Translation) Bible*. N.c.: Biblical Press Foundation, 2019.

*The New American Standard Bible*. La Habra, Cal.: The Lockman Foundation, 2020.

*The New Bible Dictionary*. Edited by J. D. Douglas. 1962 ed. S.v. "Calendar," by F. F. Bruce, pp. 176-79.

\_\_\_\_\_. S.v. "Money," by A. F. Walls, pp. 836-41.

\_\_\_\_\_. S.v. "Plagues of Egypt," by Kenneth A. Kitchen, pp. 1001-3.

\_\_\_\_\_. S.v. "Red Sea," by Kenneth A. Kitchen, pp. 1077-78.

\_\_\_\_\_. S.v. "Weights and Measures," by D. J. Wiseman and D. H. Wheaton, pp. 1319-25.

Newell, William R. *Studies in the Pentateuch*. Reprint ed. Grand Rapids: Kregel Publications, 1983.

*The New English Bible with the Apocrypha*. N.c.: Oxford University Press and Cambridge University Press. 1970.

Nichol, Francis David, ed. *The Seventh-Day Adventist Bible Commentary*. 7 vols. Washington: Review and Herald Publishing Assoc., 1953-57.

Nicholson, E. W. "The Decalogue As the Direct Address of God." *Vetus Testamentum* 27 (October 1977):422-33.

Noordtzi, A. *Numbers*. Translated by Ed van der Maas. Bible Student's Commentary series. Grand Rapids: Zondervan Publishing House, 1983.

Nowell, Irene. "Sabbath: Sign of the Covenant." *The Bible Today* 24:6 (November 1986):376-80.

Olmstead, A. T. *History of the Persian Empire*. Chicago: University of Chicago Press, 1948.

Oosthuizen, M. J. "Some thoughts on the interpretation of Exodus 4:24-26." *OTWSA* 29(1986):1-30.

Packer, J. I. *Knowing God*. 9th American printing. Downers Grove, Ill.: InterVarsity Press, 1973, 1976.

Patterson, Richard D. "The Imagery of Clouds in the Scriptures." *Bibliotheca Sacra* 165:657 (January-March 2008):13-27.

\_\_\_\_\_. "Victory at Sea: Prose and Poetry in Exodus 14—15." *Bibliotheca Sacra* 161:641 (January-March 2004):42-54.

\_\_\_\_\_. "Wonders in the Heavens and on the Earth: Apocalyptic Imagery in the Old Testament." *Journal of the Evangelical Theological Society* 43:3 (September 2000):385-403.

Paul, Shalom. *Studies in the Book of the Covenant in the Light of Cuneiform and Biblical Law*. Leiden: Brill, 1970.

Payne, J. Barton. *The Theology of the Older Testament*. Grand Rapids: Zondervan Publishing House, 1962.

Pentecost, J. Dwight. *A Faith That Endures: The Book of Hebrews Applied to the Real Issues of Life*. Grand Rapids: Discovery House Publishers, 1992.

\_\_\_\_\_. *The Glory of God*. Portland, Ore.: Multnomah Press, 1978.

\_\_\_\_\_. "The Purpose of the Law." *Bibliotheca Sacra* 128:511 (July-September 1971):227-33.

\_\_\_\_\_. *Things to Come*. Findlay, Ohio: Dunham Publishing Co., 1958, 1963.

\_\_\_\_\_. *Thy Kingdom Come*. Wheaton: Scripture Press Publications, Victor Books, 1990.

- Perevolotsky, Aviram, and Israel Finkelstein. "The Southern Sinai Exodus Route in Ecological Perspective." *Biblical Archaeology Review* 11:4 (July-August 1985):26-41.
- Petrie, Flinders. *Egypt and Israel*. New York: E. S. Gorham, 1911.
- Pfeiffer, Charles F. *Ras Shamra and the Bible*. Grand Rapids: Baker Book House, 1962.
- Phillips, Anthony. *Ancient Israel's Criminal Law*. New York: Schocken, 1970.
- \_\_\_\_\_. "A Fresh Look at the Sinai Pericope." *Vetus Testamentum* 34 (January 1984): 39-52; 34 (July 1984):282-94.
- \_\_\_\_\_. "The Laws of Slavery: Exodus 21:2-11." *Journal for the Study of the Old Testament* 30 (October 1984):51-66.
- \_\_\_\_\_. "Some Aspects of Family Law in Pre-Exilic Israel." *Vetus Testamentum* 23 (1973):349-61.
- Pink, Arthur W. *Exposition of the Gospel of John*. Swengel, Pa.: I. C. Herendeen, 1945; 3 vols. in 1 reprint ed., Grand Rapids: Zondervan Publishing House, 1973.
- Pollock, Algernon J. *The Tabernacle's Typical Teaching*. London: Pickering & Inglis, n.d.
- Pritchard, James B., ed. *Ancient Near Eastern Texts Relating to the Old Testament*. 3rd ed. Princeton: Princeton University Press, 1969.
- Proffitt, T. D., III. "Moses and Anthropology: A New View of the Exodus." *Journal of the Evangelical Theological Society* 27:1 (March 1984):19-25.
- Radday, Yehuda T. "The Spoils of Egypt." *Annual of the Swedish Theological Institute* 12 (1983):127-47.
- Ramey, William D. "The Great Escape (Exodus 14)." *Exegesis and Exposition* 1:1 (Fall 1986):33-42.
- Ramm, Bernard L. *His Way Out*. Glendale: Gospel Light Publications; Regal Books, 1974.

- Rea, John. "The Time of the Oppression and the Exodus." *Journal of the Evangelical Theological Society* 3 (1960):59-61.
- Reviv, Hanoch. "The Traditions Concerning the Inception of the Legal System in Israel: Significance and Dating." *Zeitschrift fur die Alttestamentliche Wissenschaft* 94:4 (1982):566-75.
- Richie, John. *From Egypt to Canaan*. John Richie Memorial Library series. Reprint of 5<sup>th</sup> ed. Grand Rapids: Kregel Publications, 1982.
- \_\_\_\_\_. *Tabernacle in the Wilderness*. John Richie Memorial Library series. Reprint of 1891 ed. Grand Rapids: Kregel Publications, 1982.
- Ridout, Samuel. *Lectures on the Tabernacle*. Bible Truth Library series. New York: Loizeaux Brothers Publishers, n.d.
- Robinson, Bernard P. "Symbolism in Exod. 15:22-27 (Marah and Elim)." *Revue Biblique* 94:3 (July 1987):376-88.
- \_\_\_\_\_. "Zipporah to the Rescue: A Contextual Study of Exodus IV 24-6." *Vetus Testamentum* 36:4 (October 1986):447-61.
- Rodriguez, Angel Manuel. "Sanctuary Theology in the Book of Exodus." *Andrews University Seminary Studies* 24:2 (Summer 1986):127-45.
- Rooker, Mark F. *Leviticus*. The New American Commentary series. Nashville: Broadman & Holman Publishers, 2000.
- Ross, Allen P. "When God Gives His People Bitter Water." *Exegesis and Exposition* 1:1 (Fall 1986):55-66.
- Rowley, Harold H. "Moses and the Decalogue." *Bulletin of the John Rylands Library of the University of Manchester* 34:1 (September 1951);81-118.
- Ryrie, Charles Caldwell. *Biblical Answers to Tough Questions*. Previously published as *Biblical Answers to Contemporary Issues*. Chicago: Moody Press, 1974, 1991. Ft. Worth: Tyndale Seminary Press, 2008.
- \_\_\_\_\_. "The End of the Law." *Bibliotheca Sacra* 124:495 (July-September 1967):239-47.
- \_\_\_\_\_. *The Holy Spirit*. Chicago: Moody Press, 1965.



Sachar, Abram Leon. *A History of the Jews*. 5<sup>th</sup> ed. New York: Alfred A. Knopf, 1965.

Sailhamer, John H. "Exegetical Notes: Genesis 1:1—2:4a." *Trinity Journal* 5 NS (Spring 1984):73-82.

\_\_\_\_\_. "The Mosaic Law and the Theology of the Pentateuch." *Westminster Theological Journal* 53 (Fall 1991):241-61.

\_\_\_\_\_. *The Pentateuch as Narrative*. Grand Rapids: Zondervan Publishing House, 1992.

Sarles, Ken L. "An Appraisal of the Signs and Wonders Movement." *Bibliotheca Sacra* 145:577 (January-March 1988):57-82.

\_\_\_\_\_. "A Theological Evaluation of the Prosperity Gospel." *Bibliotheca Sacra* 143:572 (October-December 1986):329-52.

Sarna, Nahum M. *Exodus*. Philadelphia: Jewish Publication Society, 1991.

\_\_\_\_\_. "Exploring Exodus—The Oppression." *Biblical Archaeologist* 49:2 (June 1986):68-79.

Sasson, J. M. "Circumcision in the Ancient Near East." *Journal of Biblical Literature* 85 (1966):473-76.

Schwantes, Siegfried J. *A Short History of the Ancient Near East*. Grand Rapids: Baker Book House, 1965.

Shafer, B. E., ed. *Religion in Ancient Egypt: Gods, Myths, and Personal Practice*. Ithica: Cornell University Press, 1991.

Shanks, Hershel. "When Did Ancient Israel Begin?" *Biblical Archaeology Review* 38:1 (January/February 2012):59-62, 67.

Sheriffs, Deryck. "Moving on with God: Key motifs in Exodus 13—20." *Themelios* 15:2 (January-February 1990):49-60.

Siker-Gieseler, Jeffrey. "The Theology of the Sabbath in the Old Testament: A Canonical Approach." *Studia Biblica et Theologica* 11:1 (April 1981):5-20.

Soltau, Henry W. *The Tabernacle, the Priesthood and the Offerings*. London: Morgan and Scott, n.d.

Speiser, E. A. "An Angelic 'Curse': Exodus 14:20." *Journal of the American Oriental Society* 80 (1960):198-200.

Sprinkle, Joe M. "Law and Narrative in Exodus 19—24." *Journal of the Evangelical Theological Society* 47:2 (June 2004):235-52.

Spurgeon, Graham. "Is Abortion Murder?" In *The Religious Case for Abortion*, pp. 15-27. Edited by Hamilton Gregory. Asheville: Madison and Polk, 1983.

Sring, Margit L. "The Horn-Motifs of the Bible and the Ancient Near East." *Andrews University Seminary Studies* 22:3 (Autumn 1984):327-40.

Steuer, Axel D. "The Freedom of God and Human Freedom." *Scottish Journal of Theology* 36:2:163-80.

Stiebing, William H., Jr. "Should the Exodus and the Israelite Settlement in Canaan Be Redated?" *Biblical Archaeology Review* 11:4 (July-August 1985):58-69.

Strange, James F. "The Jewish Calendar." *Biblical Illustrator* 13:1 (Fall 1986):28-32.

Strauss, Lehman. *The Eleven Commandments*. 2nd ed. Neptune, N.J.: Loizeaux Brothers, 1975.

*Student Map Manual*. Jerusalem: Pictorial Archive (Near Eastern History) Est., 1979.

Swindoll, Charles R. *Moses: A Man of Selfless Dedication*. Nashville: Word Publishing, 1999.

\_\_\_\_\_. *The Mystery of God's Will*. Nashville: Word Publishing, 1999.

\_\_\_\_\_. *The Swindoll Study Bible*. Carol Stream, Ill.: Tyndale House Publishers, 2017.

\_\_\_\_\_. *Three Steps Forward, Two Steps Back: Persevering through Pressure*. Nashville: Thomas Nelson Publishers, 1980.

Tan, Paul Lee. *The Interpretation of Prophecy*. Winona Lake, Ind.: BMH Books, Inc., 1974.

\_\_\_\_\_. *Principles of Literal Interpretation of the Bible*. By the Author, 1967.

Terry, Milton S. *Biblical Hermeneutics*. Reprint of the 2<sup>nd</sup> ed. Grand Rapids: Zondervan Publishing House, 1883, 1964.

Thomas, W. H. Griffith. *Through the Pentateuch Chapter by Chapter*. 1957. Reprint ed. Grand Rapids: Wm. B. Eerdmans Publishing Co., 1973

Thomson, W. M. *The Land and the Book*. 2 vols. New York: Harper & Brothers Publishers, 1873.

Tolhurst, A. H. "Whatever Happened to the Ark?" *Ministry*, June 1984, pp. 13-15.

Tozer, A. W. *The Knowledge of the Holy*. New York, et al.: Harper & Row Publishers, 1961.

\_\_\_\_\_. *The Pursuit of God*. Harrisburg, Pa.: Christian Publications, 1948.

Trimm, Charlie. "Did YHWH Condemn the Nations When He Elected Israel? YHWH's Disposition Toward Non-Israelites in the Torah." *Journal of the Evangelical Theological Society* 55:3 (September 2012):521-36.

\_\_\_\_\_. "Honor Your Parents: A Command for Adults." *Journal of the Evangelical Theological Society* 60:2 (June 2017):247-63.

Unger, Merrill F. *Archaeology and the Old Testament*. Grand Rapids: Zondervan Publishing House, 1954.

\_\_\_\_\_. *Biblical Demonology*. 7th ed. Wheaton: Scripture Press, 1967.

\_\_\_\_\_. *Demons in the World Today*. Wheaton: Tyndale House Publishers, 1974.

\_\_\_\_\_. "The Significance of the Sabbath." *Bibliotheca Sacra* 123:489 (January-March 1966):53-59.

*Unger's Bible Dictionary*, Edited by Merrill F. Unger. 1957 ed. S.v. "Cherub," by Merrill F. Unger, pp. 191-92.

- Van Baalen, Jan Karel. *The Chaos of Cults: A Study in Present-Day Isms*. 2<sup>nd</sup> revised and enlarged ed. Grand Rapids: Wm. B. Eerdmans Publishing Co., 1938, 1956.
- van der Meulen, Henry E. Faber. "One or two veils in front of the holy of holies?" *Theologia Evangelica* 18:1 (March 1985):22-27.
- Van Seters, John. *The Hyksos*. New Haven: Yale University Press, 1966.
- Velikovsky, Immanuel. *Worlds in Collision*. Paperback ed. New York: Pocket Books, Simon and Schuster, 1950.
- von Rad, Gerhard. *Old Testament Theology*. 2 vols. Translated by D. M. G. Stalker. New York and Evanston, Ill.: Harper & Row, 1962 and 1965.
- Voss, Robert J. "Who Am I That I Should Go? Exodus 3:11 (Ex. 2:25--4:18)." *Wisconsin Lutheran Quarterly* 80:4 (Fall 1983):243-47.
- Wagner, George. *Practical Truths from Israel's Wanderings*. Reprint of *The Wanderings of the Children of Israel*. London: J. Nisbet & Co.: 1862. Grand Rapids: Kregel Publications, 1982.
- Wagner, Maurice E. "How to Honor Your Parents When They've Hurt You." *Psychology for Living* 28:6 (June 1986):12-14.
- Waltke, Bruce K. "Cain and His Offering." *Westminster Theological Journal* 48:2 (Fall 1986):363-72.
- \_\_\_\_\_. *An Old Testament Theology*. Grand Rapids: Zondervan Publishing House, 2007.
- \_\_\_\_\_. "Palestinian Artifactual Evidence Supporting the Early Date of the Exodus." *Bibliotheca Sacra* 129:513 (January-March 1972):33-47.
- \_\_\_\_\_. "Reflections from the Old Testament on Abortion." *Journal of the Evangelical Theological Society* 19:1 (Winter 1976):3-13.
- Walvoord, John F. *The Holy Spirit*. Wheaton, Ill.: Van Kampen Press, 1954; Findlay, Ohio: Dunham Publishing Co., 1958.

- \_\_\_\_\_. "The New Covenant." In *Integrity of Heart, Skillfulness of Hands*, pp. 186-200. Edited by Charles H. Dyer and Roy B. Zuck. Grand Rapids: Baker Book House, 1994.
- Ward, William A. *The Spirit of Ancient Egypt*. Beirut: Khayats, 1965.
- Watson, Thomas. *The Ten Commandments*. 1692. Reprint ed. Edinburgh: The Banner of Truth Trust, 1976.
- Wenham, Gordon J. *The Book of Leviticus*. New International Commentary on the Old Testament series. Grand Rapids: Wm. B. Eerdmans Publishing Co., 1979.
- Wenham, John W. *The Goodness of God*. Downers Grove: InterVarsity Press, 1974.
- Westcott, Brooke Foss. *The Epistle to the Hebrews*. Grand Rapids: Wm. B. Eerdmans Publishing Co., n.d.
- Whybray, R. Norman. *Introduction to the Pentateuch*. Grand Rapids: Wm. B. Eerdmans Publishing Co., 1995.
- Whyte, Alexander. *Bible Characters*. One-volume ed. Grand Rapids: Zondervan Publishing House, 1973.
- Wiersbe, Warren W. *The Bible Exposition Commentary/Pentateuch*. Colorado Springs, Colo.: Cook Communications Ministries, 2001.
- Williams, Gary R. "The Purpose of Penology in the Mosaic Law and Today." *Bibliotheca Sacra* 133:529 (January-March 1976):42-55.
- Wilson, Robert Dick. "Yahweh (Jehovah) and Exodus 6:3." In *Classical Evangelical Essays in Old Testament Interpretation*, pp. 29-40. Edited by Walter C. Kaiser, Jr. Grand Rapids: Baker Book House, 1972.
- Wilson, Robert R. "The Hardening of Pharaoh's Heart." *Catholic Biblical Quarterly* 41:1 (1979):18-36.
- Winter, Ralph D. "The Growth of Israel in Egypt (The Phenomenon of Exponential Growth)." Paper published by the Institute of International Studies, Pasadena, Ca., 14 April 1993.

Wolf, Herbert M. *An Introduction to the Old Testament Pentateuch*. Chicago: Moody Press, 1991.

Wolinski, Arelene. "Egyptian Masks: The Priest and His Role." *Archaeology* 40:1 (January-February 1987):22-29.

Wood, Bryant G. "The Rise and Fall of the 13th-Century Exodus-Conquest Theory." *Journal of the Evangelical Theological Society* 48:3 (September 2005):475-89.

\_\_\_\_\_. "The Biblical Date for the Exodus is 1446 BC: A Response to James Hoffmeier." *Journal of the Evangelical Theological Society* 50:2 (June 2007):249-58.

Wood, Leon J. *The Prophets of Israel*. Grand Rapids: Baker Book House, 1979.

\_\_\_\_\_. *A Survey of Israel's History*. Grand Rapids: Zondervan Publishing House, 1970.

Woudstra, Marten H. *The Book of Joshua*. New International Commentary on the Old Testament series. Grand Rapids: Wm. B. Eerdmans Publishing Co., 1981.

Wright, G. Ernest. "The Significance of the Temple in the Ancient Near East." *Biblical Archaeologist* 7:4 (December 1944):65-77.

Wyatt, N. "The Significance of the Burning Bush." *Vetus Testamentum* 36:3 (July 1986):361-65.

*The Wycliffe Bible Encyclopedia*. Edited by Charles F. Pfeiffer, Howard F. Vos, and John Rea. 1975 ed. 2 vols.

Wyrick, Stephen Von. "Israel's Golden Calves." *Biblical Illustrator* 13:1 (Fall 1986):3-12.

Young, Edward J. *My Servants the Prophets*. Grand Rapids: Wm. B. Eerdmans Publishing Co., 1952.

Young, Rodger C., and Bryant G. Wood. "A Critical Analysis of the Evidence from Ralph Hawkins for a Late-Date Exodus-Conquest." *Journal of the Evangelical Theological Society* 51:2 (June 2008):225-43.

Youngblood, Ronald F. *Exodus*. Everyman's Bible Commentary series. Chicago: Moody Press, 1983.

\_\_\_\_\_. "A New Look at an Old Problem: The Date of the Exodus." *Christianity Today* 26:20 (December 17, 1982):58, 60.

Yurco, Frank J. "3,200-Year-Old Picture of Israelites Found in Egypt." *Biblical Archaeology Review* 16:5 (September/October 1990):22-38.

Zuck, Roy B. *Basic Bible Interpretation*. Wheaton, Ill.: Victor Books, 1991.

\_\_\_\_\_. "The Practice of Witchcraft in the Scriptures." *Bibliotheca Sacra* 128:512 (October-December 1971):352-60.